



• Hisense

85" U88N

U88N Series Mini-LED QLED 4K Google TV
Model-85U88N



Experience unparalleled brightness, colour, and detail with the U88N's Mini-LED PRO and Quantum Dot technology. Enjoy smooth action with its native 144Hz refresh rate, perfect for movies, sports, and gaming. Immerse yourself in cinematic audio with Dolby Atmos-powered 2.1.2 multi-channel audio, bringing heart-pounding action, intense gameplay, and immersive sports viewing to life.



QLED

Quantum Dot Wide Colour Gamut technology reproduces over a billion colour combinations for a wider spectrum of colours for true to life images.



Full Array Local Dimming

Equipped with up to 1,296 dimming zones combined with state-of-the-art video processing, the results are intense black levels with vibrant colour reproduction.



Game Mode PRO

Serious gamers wanted! With a winning combination of technology, 144Hz Game Mode Pro is the one to beat. A variable refresh rate from 48Hz to 144Hz ensures that your console and PC gaming will meet any opponent head on. AMD FreeSync™ Premium Pro and Auto Low Latency Mode virtually eliminate screen tearing and controller input lag. Dominate the game – it's time to level up!



Dolby Atmos Sound (2.1.2 Channel with Subwoofer)

Elevate your auditory experience with award-winning audio enhancement that unveils what you've been missing. Take your movie and gaming escapades to new heights with a 2.1.2 audio channel featuring a subwoofer, enhanced by Dolby Atmos for precise three-dimensional audio placement that breaks free from conventional channels.



Mini-LED PRO

Smaller LED's allow for more of them to be incorporated into our back-light technology. This leads to the delivery of superior brightness, richer colours, and sharper details compared to conventional LED TVs.



144Hz Refresh Rate

Whether it's sports, action movies or pure gaming, this high frame rate greatly reduces motion blur to reproduce a clearer picture.



High Brightness Level

With a brightness level of 2,500 nits in Hisense TVs, you can enjoy an optimal viewing experience even in well-lit rooms with abundant lighting.



Low Reflection Screen

The Low Reflection Screen minimizes distractions from reflections, reducing up to 75% of unwanted glare. Enjoy uninterrupted midday matches and evening movies without sunlight or lamp reflections disrupting your viewing experience.



Total HDR Solution

Hisense TVs have taken the sensible approach to HDR with support for all major formats, including Dolby Vision, HDR10, HDR10+, and HLG. Never worry about subpar video quality or compatibility again.



Hisense

85" U88N

U88N Series Mini-LED QLED 4K Google TV Model-85U88N

TECHNICAL SPECIFICATIONS

Display

Class Size	85"
MiniLed Technology	Y
Quantum Dot Technology	Y
Native refresh rate (Hz)	144Hz
AI	AIPQ Local TMO
Display Aspect Ratio	16:09
Display	flat
Resolution	4K 3840x2160
Peaking Brightness (typical nits)	2500
Backlight	DLED
Local Dimming Zones	1296
Wide colour Gamut	Y
4K Upscale	Y
MEMC	Y
Motion Rate	480
HDR Processing	Yes (Dolby Vision/HDR10/HDR10+/HLG)
Film Maker Mode	Y
HSR	HSR 240
VRR (Variable Refresh Rate)	VRR 48-144 Hz
ALLM (Auto Low-latency Mode)	Y
AGLR (Low Reflection)	N

AUDIO

Audio Enhancement	Dolby Atmos/ DTS Virtual:X
Multi-Channel Audio	2.1.2 CH
Audio Power	2*15W+20W+2*5W
Speaker Type	Embedded (down)
Bluetooth Audio	Y

CONNECTIVITY / PORTS

Wi-Fi	802.11 ax Three band (2.4/5/6 GHz)
Bluetooth	BT 5.3
RF Antenna	1
HDMI Inputs	HDMI2.0*2 HDMI2.1*2
HDMI-eARC	HDMI1
USB	USB3.0*1 USB2.0*1
Ethernet (LAN)	1
Earphone/Audio Output	1
Digital Audio Output	1

OTHER FEATURES

Smart Platform	Google TV
On Screen Display	Eng/Fre/Spa
TV System	ATSC3.0/ISDB/NTSC
Noise Reduction	Y
Parental Control	Y
Sleep Timer	Y
Far-field Voice Recognition	Y
Googel Assistant	Y
Alexa	work with Alexa
Screen Mirror	DLNA\Miracast
Wall Mount Size	600x400
Wall Mount Screw	M8

Power

Power Consumption	480W
Standby Consumption	≤0.5W
Power Supply (Voltage/Hz)	AC 100V-240V/50Hz/60Hz

DIMENSIONS / WEIGHT

TV Dimension (without the stand)	74.8×43.1×3.0 (inch), 1899×1096×77 (mm)
TV Dimension (with the stand)	74.8×45.9×15.7 (inch), 1899×1166×400 (mm)
Stand Width (LxW)	17.3×15.7 (inch), 440×400 (mm)
Carton Dimensions(WxHxD)	82.7×51.3×9.8 (inch), 2100×1304×248 (mm)
TV Weight (without the stand)	106.9 (lb), 48.5 (kg)
TV Weight (with the stand)	125.7 (lb), 57 (kg)
Gross Weight (lb) (kg)	160.9 (lb), 73 (kg)
Weight of carton box (lb) (kg)	22.71 (lb), 10.3 (kg)

ACCESSORIES

Remote	Y
Battery	2
Power cord	Y
QSG	Y
Safety and Warranty	Y
Stand	Single Stand

WARRANTY/UPC

Warranty	1 Year
UPC Code	888143019185

REMARK: Specifications and design may be changed without prior notice.

All product, product specifications, and data are subject to change without notice to improve reliability, function, design or otherwise.
©2024 Hisense Canada, All rights reserved

Hisense

USER MANUAL

Before using the TV, please read this manual thoroughly and retain it for future reference.

ENGLISH

FRANÇAIS

ESPAÑOL

Hisense

USER MANUAL

Before using the TV, please read this manual thoroughly and retain it for future reference.

ENGLISH

Copyright Statement

© 2023 Hisense Company Ltd. All Rights Reserved.

All material in this User Manual is the property of Hisense Company Ltd. and its subsidiaries, and is protected under US, CANADA, MEXICO and International copyright and/or other intellectual property laws. Reproduction or transmission of the materials, in whole or in part, in any manner, electronic, print, or otherwise, without the prior written consent of Hisense Company Ltd. is a violation of Hisense Company Ltd. rights under the aforementioned laws.

No part of this publication may be stored, reproduced, transmitted or distributed, in whole or in part, in any manner, electronic or otherwise, whether or not for a charge or other or no consideration, without the prior written permission of Hisense Company Ltd.

Requests for permission to store, reproduce, transmit or distribute materials may be made to one of the following addresses:

USA: Hisense USA Corporation
105 Satellite BLVD Suite I,
Suwanee, GA 30024

CANADA: Hisense Canada Co., Ltd
2283 Argentia Road, Unit 16
Mississauga, ON, Canada
L5N 5Z2

MEXICO
IMPORTER:
Hisense Mexico S. de R.L. de C.V.
Blvd. Miguel de Cervantes Saavedra No 301
Torre Norte Piso 2, Col. Ampliación Granada
Miguel Hidalgo, Ciudad de México, C.P. 11520
RFC: HME110512IY3
TEL: (52) (55) 5531-3515

Hisense, and any and all other Hisense product names, logo's, slogans or marks are registered trademarks of Hisense Company Ltd. and its subsidiaries. All other trademarks are the property of their respective holders.

©2023. All rights reserved. Hisense and the Hisense logo are registered trademarks of Hisense. Other brand and product names are registered trademarks of their respective owners.

Disclaimer Page

**Notwithstanding anything to the contrary, including in any or all descriptions, representations, statements or other communications related to this Hisense device (hereinafter "Device") made in any form whatsoever and at any time, some or all of the pre-installed, or subsequently installed Application Services may not be available or capable of functioning as intended by the provider of the Application Services in any or all usage areas for reasons outside of Hisense's control, including but not limited to, Internet access, local service limitations, etc. Any purchase or use of the Device, including any Application Services, is purely at the user's risk. Application Services are provided on an as-available basis without warranties of any kind, either expressed or implied, that the Application Service will be uninterrupted or error-free, including but not limited to vagaries of weather, disruption of Service, acts of God, warranties of title, local or regional limitations, no infringement, NOR IMPLIED WARRANTIES OF MERCHANTABILITY OR FITNESS FOR A PARTICULAR PURPOSE. No advice or information given by Hisense, providers, affiliates, or contractors or their respective employees shall create such a warranty. Hisense specifically disclaims responsibility for any or all Application Services from functioning at any time, and by purchasing the Device, you accept such disclaimer without any claim on Hisense. You are solely responsible for providing an active and working connection to the Internet, along with any and all hardware and/or software necessary to use the Hisense Device as intended.

Disclaimer:

Images throughout this document are for illustrative purposes only and may differ from the actual product.

Contents

First-Time Use

Using the E-Manual.....	3
Home Screen.....	3
Connecting to the Internet.....	3
Prepare Live TV.....	5
Using External Devices.....	5
Recommended Topics.....	6

Enjoy Live TV

Channel Scan.....	7
Live Menu.....	7
Channel Edit.....	9
Learn about Live TV Support Settings.....	11

Benefits of Smart TV

Using a Google Account.....	15
Using Voice Control.....	15
Content Sharing.....	18
Using Apps.....	18
Apps Settings and Permissions.....	19
Enhanced Viewing.....	20

Connecting to External Devices

Remote & Accessories.....	21
Connecting Bluetooth Devices.....	22
Sharing your Smart Phone/Computer Screen on the TV.....	23
Using AirPlay and HomeKit.....	24
Connecting USB Devices.....	25
Connecting Headphones.....	25
Connecting Audio Visual (AV) Devices.....	26
Connecting Speakers or Other Audio Receivers.....	27
Connecting a Digital Audio System with ARC/eARC.....	27
Connecting a PC.....	28

Settings Overview

Picture.....	29
Screen.....	32
Sound.....	33
Audio Output.....	35
Network & Internet.....	37
General.....	37

Contents

System message.....	40
Using Parental Control.....	41
Reset to Factory Default.....	42

Entertainment

Game.....	43
SoundBar Settings.....	44
Sports.....	44
Media.....	45

Accessibility Features

Accessibility Menu Setup.....	49
-------------------------------	----

Troubleshooting

FAQ.....	50
Picture Issues.....	56
Sound Issues.....	57
Network Issues.....	57
Channel and Broadcast Issues.....	58
External Device Connection Issues.....	58
HDMI & CEC Issues.....	59
Application Issues.....	59
Media Files.....	59
Voice Service Issues.....	60
Other Issues.....	60

Using the E-Manual

View the embedded E-Manual that contains information about your TV's key features.

Disclaimer:

Instructions and images through this manual are only for reference and may differ from the actual product.

Launch the E-Manual

Press  button on your remote control to select **Settings > System > Advanced System > E-Manual**.

Scan the QR Code with your Smart Phone to open the E-Manual on your device.

Note:

- The black background icon stands for the button on the remote control.
- The grey background icon stands for the icons on the screen of the device for selecting.

Use the Buttons in the E-Manual

Search

You can use  icon on the top of the E-Manual to search for the product feature information, and the E-Manual will provide all the titles and content that contains the search information.

Setting

You can use  icon on the top of the E-Manual home screen to adjust the text size.

Home Screen

All TV functions can be accessed from the Home screen.

Display the Home Screen

Press  button on your remote control to enter the Home screen.

To exit the Home screen, use your remote control or use the navigation buttons on the screen to move the cursor to other icons, press  button to enter and select your desired service.

Connecting to the Internet

To get access to the Internet using a wired connection or connecting to an available wireless network.

Connect to a Wired (Ethernet) Network

To get access to the Internet using a wired connection, it is recommended to use a modem or router that supports Dynamic Host Configuration Protocol (DHCP). Modems and routers that support DHCP automatically provide the IP address, subnet mask, gateway, and DNS, so you do not have to enter them manually. Most home networks already have DHCP.

See the illustration below.

First-Time Use

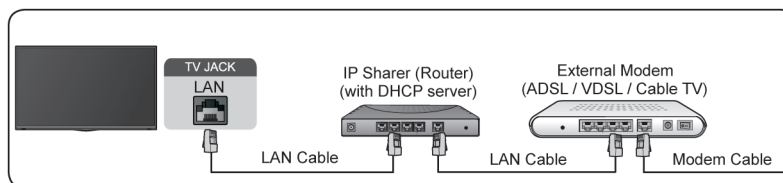

After connecting to a wired (Ethernet) network:

Press  button on your remote control to select **Settings > Network & Internet**.

Go to ETHERNET section, and set the TV network by pressing  button to enter the submenu.

- **Connection Type**

Show whether the Ethernet is connected.

- **Proxy settings**

You can set the proxy server.

- **IP settings**

Configure the IP setting for your network connection.

 **Related information**

[Network & Internet](#) on page 37

[Network Issues](#) on page 57

[My TV cannot connect to the network.](#) on page 52

Connect to a Wireless Network

To connect to an available wireless network, make sure that you turn on your wireless router and have the wireless router's SSID and password before attempting to connect.

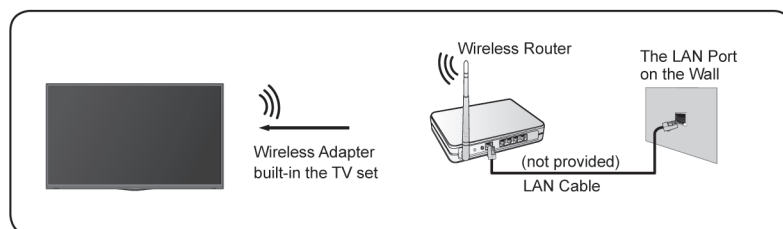

To get access to the Internet using a wireless connection:

Press  button on your remote control to select **Settings > Network & Internet > Wi-Fi**.

To get access to the Internet in a wireless way:

1. Turn on your **Wi-Fi**.
2. The list of networks will display automatically.
3. Select a wireless network from the list, and input the password.
4. If the network connection does not appear in the list, select **See all** to display all the list, or select **Add new network** to input a wireless network name, select the type of security mode, and enter password.

First-Time Use

☰ Related information

[Network & Internet](#) on page 37

[Network Issues](#) on page 57

[My TV cannot connect to the network.](#) on page 52

Internet Related Features

- Content Sharing

To view media content, like videos, music or photos saved in your Android/iOS/PC device on your TV screen. For more information, please refer to [Benefits of Smart TV > Content Sharing](#) in this manual.

- Sharing your Smart Phone/Computer Screen on the TV

To mirror your mobile device or computer screen to the TV. For more information, please refer to [Connecting to External Devices > Sharing your Smart Phone/Computer Screen on the TV](#) in this manual.

Prepare Live TV

Connect antenna/cable to the TV

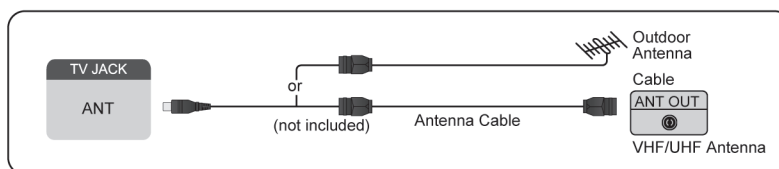

Note:

- TV jacks may vary and antenna/cable function may not be applicable in some models/countries/regions.
- You may also connect devices that can receive broadcast signals such as a Set Top Box.

Start auto scan or manual scan

1. Press **INPUT** > TV
2. Press **⚙️** button on your remote control to select **Settings > Channels & Inputs > Channels > Auto Channel Scan / Manual Scan**, or Press **⚙️** button on your remote control to select **Settings > Channels & Inputs > Channels > Auto Channel Scan / DTV Manual Scan / ATV Manual Scan**.

Note:

- The function above may vary depending on actual products.

☰ Related information

[Channel Scan](#) on page 7



Using External Devices

Switch between external devices connected to the TV

1. Press **INPUT** button on your remote control.
2. Select your desired input source.

First-Time Use

Edit the name of input sources

1. Press  button on your remote control.
2. Press  button to rename input.

Note:

- Maximum name length is 36 characters.

Recommended Topics

Install an App

Install apps from App Store for your entertainment preferences. For more information, please refer to [Benefits of Smart TV > Using Apps > Install an App](#) in this manual.

Picture

Adjust picture mode and other advanced picture settings. For more information, please refer to [Settings Overview > Picture](#) in this manual.

Screen

Change the picture size and use the overscan function. For more information, please refer to [Settings Overview > Screen](#) in this manual.

Sound

Adjust sound mode and other advanced sound settings. For more information, please refer to [Settings Overview > Sound](#) in this manual.

Audio Output

Select speakers and adjust the audio output settings. For more information, please refer to [Settings Overview > Audio Output](#) in this manual.

Keep the TV updated

Set your TV to receive the latest firmware. For more information, please refer to [Settings Overview > System message > System Update](#) in this manual.

Channel Scan

You can scan for channels automatically or manually.

Note:



- Antenna/cable function may not be applicable in some models/countries/regions.

Auto Channel Scan

Automatically scan for channels to view programs from your TV source.

 > **TV**

If no TV channels were saved before, you will be prompted to do a channel search.

In Live TV,  /  > **Channel Settings > Channels > Auto Channel Scan**

Before you select Auto Channel Scan, you can press  /  > **Channel Settings > Channels > Tuner Mode** to select **Antenna** or **Cable**.

Manual Scan

In Live TV,  /  > **Channel Settings > Channels > Manual Scan**

Type in a channel to add it manually to your TV.

In Live TV,  /  > **Channel Settings > Channels > DTV Manual Scan**

In Live TV,  /  > **Channel Settings > Channels > ATV Manual Scan**

Live Menu

You can obtain quick access to the channel list, favorite channel list or use relevant features with ease when watching TV programs.

Display Channel List

In Live TV, press  button on the remote control to display the Channel List menu.

Learn about channel list sub-menu.

In Live TV,  > 

Enjoy Live TV



TV List

Display Live TV channel categories, such as **Cable** and **Antenna**.

Fav

Display favorite lists.

History

Display the channels that have been watched for a period of time.

Edit

Edit the channel list.

Note:

- The sub-menu options may vary depending on models/countries/regions.

Related information

[Edit Channel List](#) on page 9

Display Favorite Channel List

In Live TV, press **OK** > **➤** > **♥** to select **FAV**, and press **OK** button to display the favorite list.

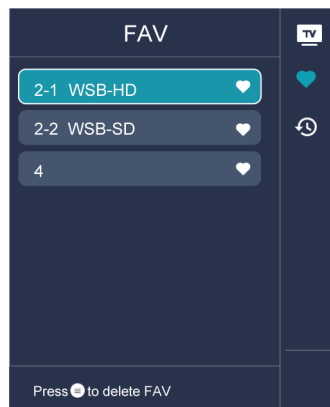

Enjoy Live TV

Note:

- These steps should be operated under TV inputs.

☰ Related information

[Edit Favorite Channel List](#) on page 10

Channel Edit

Manually edit the channel list or favorite channel list to your preference.

Edit Channel List

Before you can edit the channel list, Channel Scan must be completed first.

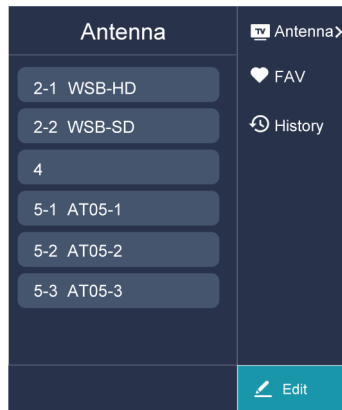

Manage the Channels

In Live TV, press **OK** > **➤** to select a Live TV channel category such as Antenna or Cable, then use D-pad to select **Edit**.

- Delete:

1. Select the channel you want to delete, or press **OK** to select more channels.
2. Press **➤** button to delete.

- Restore: Press **123** button to display the colour menu and select RED to enter the list of deleted channels. Press **◀** button to restore the deleted channel.

Enjoy Live TV

Delete the channel in focus or press [OK] to select more channels

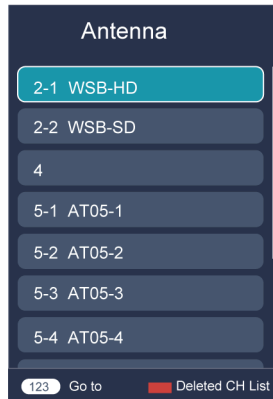

Edit Favorite Channel List

Before you can edit the favorite list, Channel Scan must be completed first.

Add a channel to a favorite list

You can add channels from various reception types to the favorite list.

1. In Live TV, press **OK** button to display the channel list.
2. Press **MENU** button, select the channel(s) you want to add to the favorite list by pressing **OK** button.
3. Press **←** button to select **Add to Favorite**.
4. Press **OK** button to confirm.
5. Then a heart-shape icon will appear next to the added channel.

Enjoy Live TV

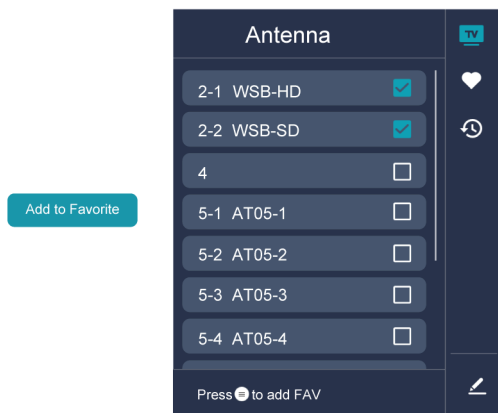

Move or remove channels in a favorite list

If you want to remove favorite channels:

1. In Live TV, press **OK** > **→** > **▼** to select **FAV**, and press **OK** button to display the favorite list.
2. Press **☰** / **MENU**, select the channel(s) you want to delete to the favorite list by pressing **OK** button.
3. Press **←** button to select **Delete Fav. Channel**.
4. Press **OK** button to confirm.
5. Then the channel you select will disappear on the FAV list.

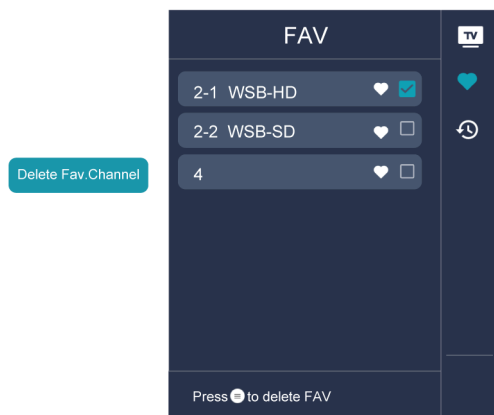

Note:

- These steps should be operated under TV inputs.
- Before you edit the favorite lists, complete channel scan first.

☰ Related information

[Channel Scan](#) on page 7

Learn about Live TV Support Settings

You can set audio language or default audio output language, etc.

Audio Language (MTS)

You can choose the audio language in DTV mode and you can set MTS for **Mono**, **Stereo** or **SAP** in ATV mode.

In Live TV, press  /  > **Channel Settings** > **Audio Language (MTS)**.

Primary Audio/Secondary Audio

- **Primary Audio**

Set the default audio output language for the type of digital broadcast content that you are viewing.

- **Secondary Audio**

Set the secondary audio output language for digital broadcast content.

Note:

- If your selected Primary Audio and Secondary Audio are included in the MTS list, the MTS list defaults to Primary Audio and Secondary Audio settings after you switch channel or turn on/off the TV.

Video Description

Enables broadcasted descriptive audio for visually impaired.

Press  button on your remote control to select **Settings** > **Channels & Inputs** > **Channels** > **Video Description**.

 **Related information**

[Accessibility Menu Setup](#) on page 49

Guide

The Guide provides a convenient way to check TV programmes for the upcoming 7 days. The information displayed by the Guide is made available by the commercial television networks for digital channels only. The Guide also provides a simple way to record your favourite programmes and a reminder function, which can switch channels automatically at scheduled times, so that you will not miss programmes of interest. The availability and amount of programme information will vary depending on the broadcaster.

Note:

- The Guide function is only available for digital channels. Analogue channels are not supported.

Launch the Guide

In Live TV, press  /  > **Channel Settings** > **Guide** to display programme guide.

Learn about the Guide menu

- **Watch**

In Guide, when a current programme is selected, press  to switch to the channel you want to see.

Enjoy Live TV

- **PVR/Reminder**

In Guide, press **▲/▼** button to select the channels. Press **◀/▶** button to select programme based on the time schedule.

Press **OK** button to select **PVR** or **Reminder**.

Note:

- The PVR function may not be applicable in some models/countries/regions.

- **Scheduled**

In Guide, press **123** button to display the colour menu and select RED. This will display a list of scheduled reminders and recordings.

- **Detail**

In Guide, press **123** button to display the colour menu and select GREEN. Details of the selected programme will be displayed.

Note:

- This function may not be applicable in some models/countries/regions.

- **24h-**

In Guide, press **123** button to display the colour menu and select YELLOW to select programmes of the previous day.

- **24h+**

In Guide, press **123** button to display the colour menu and select BLUE to select programmes of the next day.

PVR Setting

Note:

- This function may not be applicable in some models/countries/regions.

The PVR function allows you to easily record digital television content for later viewing.

Press **⊙** button on your remote control to select **Settings > Channels & Inputs > Channels > PVR & Time Shift Setting**.

- Format the external USB disk to support PVR and Time-Shift. When you connect more than one USB storage device to the TV, the one selected in **PVR Setup** or **Time Shift Setup** is initialised for starting recording or launching timeshift. The recorded programme will be saved in the selected storage device. When launching timeshift, programme will be recorded temporarily to the selected storage device.
- You can add padding time to start recording before the event starts, or after the event has finished by delaying the end of recording depending on how much Padding time is added, this is setup in **Start in advance** or **Delay Ending**.
- When your TV is in standby mode, you may miss the programme you want to watch. If **Reminder Power On** is enabled, even when your TV is in standby mode, it can be powered on automatically by the Reminder time you have set.
- When **Permanent Timeshift** is enabled, the TV will start Timeshift automatically every time you begin to watch a live TV channel. If you change the channel, Timeshift will restart from when the channel was changed. When **Permanent Timeshift** is turned off, Timeshift will begin from the time you start the function.

Enjoy Live TV

Interactive Service

You can set Interactive Service **On** or **Off**, if your TV support ATSC3.0.

Secure Channel Viewing

Provides warnings for you about insecure channels.

Benefits of Smart TV

Using a Google Account

Sign in with Google to get apps, Google Assistant, and personalized recommendations.

Signing into an account

When you turn on the TV for the first time, you can select **Set up Google TV** to sign into a Google Account by the setup guide, if you select **Set up basic TV**, you can also set it later by pressing  to select **Set up Google TV**.

- Set up with the Google Home app
- Set up on TV instead

Before signing into your Google account, make sure your TV is connected to the network. For more about network settings, please refer to [Connect to a Wired \(Ethernet\) Network](#) or [Connect to a Wireless Network](#) in this manual, after the network is connected, enter your E-mail/phone and password, select **Sign In**.

Adding a kid account



You can create a personalized space for your kid with access to content they love and tools to help keep you in control.

1. After the network is connected,  > **Settings > Accounts & sign-in > Add a kid**.
2. Set up Google TV for a kid in your family, you can do the same for more kids later.

Adding another account

You can use other accounts within Google apps like YouTube, but you won't see recommendations for those accounts on the Google TV home screen.

Before creating a new account, make sure your TV is connected to the network. For more about network settings, please refer to [Connect to a Wired \(Ethernet\) Network](#) or [Connect to a Wireless Network](#) in this manual.

1. After the network is connected,  > **Settings > Accounts & Sign-in > Add an account**.
2. Enter E-mail/phone and password.
3. Press .

Using Voice Control

Set up voice assistant to control your TV just by your voice.

Google Voice Setup

Voice Control may not be applicable in some models/countries/regions.

Google Assistant



You can ask for information, search for your favorite movies, control your TV and more, just by asking Google Assistant.

Before setting up Google Assistant, connect your TV to the network and sign in your Google account.

How to start Google Assistant

You can choose this way to start Google Assistant:

Benefits of Smart TV

- Press  /  button on your remote control.

Note:

- To start Google Assistant, you need to pair the remote first.
- The Google Assistant function may not be applicable in some models/countries/regions.
- The setup steps above may vary depending on actual products.

Hands-free Voice Control



Google Assistant can answer your questions or help you change TV configuration.

Before using this function, connect the TV to the Internet and sign in your Google account by pressing  and selecting **Settings > Accounts & Sign In**.

Note:

- Hands-free Voice Control may not be applicable in some models/countries/regions.

How to set up Hands-free Voice Control

1. Switch the control button on the bottom of the TV to  to turn on the microphone.
2. Pair the remote first, press  /  button to select "Yes, I'm in".
3. Start a conversation by saying "Hey Google", and the dialog bar appears at the top of the TV screen. At the same time, indicator lights illuminate.
4. Continue speaking, such as "What's the weather" or "volume up".

Screenless mode

 > **Settings > System > Advanced System > Screenless Mode**

Talk to Google Assistant when the screen is off.

In Screenless Mode, Google Assistant is always available to help even when the screen is not on. Just say "Hey Google".

This feature will affect standby power consumption. To turn it off, press  button, select **Settings > System > Advanced System > Screenless Mode**.

Note:

- Google Assistant and some features are available on limited country/region/language.
- Screenless mode is only for models with far-field Google Assistant.

Alexa Setup

Set up to control your TV with any Alexa-enabled devices. Alexa can help you change the TV configuration. Using just your voice, you can change inputs, volume, channels, and more. Just ask Alexa.

What is required to control your TV with Amazon Alexa?

- Android TV models that support the Alexa skill.
- Amazon Echo device or Alexa App.
- Amazon account for Alexa App or Echo device, if you don't have the account, please create one before the setup process.
- My Brilliant Life account to link your TV, you can create it before the setup process or in the period.

Benefits of Smart TV

- Home network with Wi-Fi capabilities.
- For issues of accessing your Amazon account and using the Alexa app during setup, please visit amazon.com for help.

How to set up Alexa

1. Press , select **Settings > System > Advanced System > TV control with Alexa**.
2. Select **Enable Now**.
3. Link the TV to My Brilliant Life account. Scan the QR code with your phone, or visit the website on your phone or computer, sign in your My Brilliant Life account, and enter the code showed on the TV. The webpage and code will be expired after a few minutes.
4. Next, your TV screen shows a list of TV name. Select one from it or enter a custom name. Then, your TV will appear in the device name list on your phone or computer.
5. Download the Alexa app on your smart phone. Open the app and sign in with your Amazon account.
6. In the Alexa app, select Skills section, search and enable My Brilliant Life skill. Follow the instructions to link your Amazon account by entering the same My Brilliant Life account that you've signed on your TV.
7. After you enabled the skill and the TV is discovered in Alexa app, the TV page will automatically jump.
8. Now you can ask Alexa try some functions available for TV.

Note:

- Use external Alexa-enabled devices (e.g. Alexa App, Echo) to control your smart TV by using just your voice.
- After your My Brilliant Life account is created but you can't see the Link your TV step on your phone or computer, please sign out account and re-visit URL and sign in again.
- If you do not see "TV control with Alexa" in the System settings, then your TV does not support Alexa.
- The Alexa function may not be applicable in some models/countries/regions.
- The setup steps above may vary depending on actual products.

Voice Service Other Issues

If you want to turn on your TV with Alexa-enabled devices (e.g. Echo, Echo show) or Google Home devices (e.g. Google Home, Google Nest Hub), please:

1. Turn on **Screenless Mode**(for FFM)/**Wake on Cast** (for No-FFM) at  > **Settings > System > Advanced System**.
2. Make sure your TV and Alexa-enabled devices/Google Home devices are connected to the same network environment.

Note:

- Only Alexa (Alexa skill is enabled) and Google Smart Home Service support turning on your TV with Alexa Echo or Google Home.
- This function may not be applicable in some models/countries/regions.

Related information

[Connect to a Wired \(Ethernet\) Network](#) on page 3

[Connect to a Wireless Network](#) on page 4

Benefits of Smart TV

Content Sharing

Content Sharing allows you to view media content, like videos, music or photos saved in your Android/iOS/PC device on your TV screen.

Share Media Content from your Device

1. Connect your TV and Android/iOS/PC device to the same network.
2. Turn on Content Sharing at **⚙️ > Settings > System > Advanced System > Content Sharing**.
3. Turn on the content sharing function in your Android/iOS/PC device.
4. Find the TV name in the search list of your device and select it. Wait for the connection progress to complete.
5. On your Android/iOS/PC device, choose the media content you want to share on your TV.

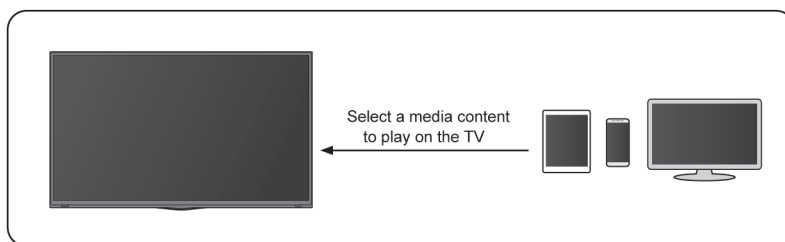

☰ Related information

[Connect to a Wired \(Ethernet\) Network](#) on page 3

[Connect to a Wireless Network](#) on page 4

Play Media Content from your Device on the TV

You can connect media content saved in your Android/iOS/PC device to your local network and play the content on your TV.

1. Connect your TV and Android/iOS/PC device to the same network.
2. Turn on Content Sharing at **⚙️ > Settings > System > Advanced System > Content Sharing**.
3. Make sure your media content in your Android/iOS/PC device are visible through the local network.
4. On your TV, select a device with media content at **⚙️ > Settings > Apps > MediaCenter**, or **🏠 > Your apps > MediaCenter**. The media content list in your Android/iOS/PC device appears.
5. Select a media content item from the list to play.

Note:

- Content may not be played depending on the file format.
- Content may not be played smoothly, or the function may not work properly due to the network condition.

Using Apps

🏠 > Apps

From the Apps screen, there are many recommended apps for you, you can find your favorites and use them very easily.

You can find popular apps by App categories, other devices, etc.

Benefits of Smart TV

Numerous factory-installed apps are available for you to choose for your entertainment preferences.

Install an App

Even though your TV has numerous factory-installed apps, there may be others that you would like to download.

To install an app:

1. From the Apps screen, you can use the search box to search for your apps and games that you want to install.
2. Select the **Install**. The selected app is installed on the TV.

Note:

- To use this function, your TV must be connected to the Internet.
- Adding apps is free, but it might cost you money when using some apps.

Manage Apps

To move an app:

1. From the Apps screen, use the navigation buttons on your remote control to select the app that you want to move. Long press **OK** button.
2. Select **Move**.
3. Use the navigation buttons on your remote control to move the location of the app. Press **OK** button to confirm.
4. Press **←** button to finish.

Remove an App

You can only delete apps that you've installed to the TV. Factory-installed apps can not be deleted.

To delete an app:

1. From the Apps screen, use the D-pad on your remote control to select the app that you want to remove. Long press **OK** button and select **view details**.
2. Select **Uninstall**.
3. A dialog message displays that asks "Do you want to uninstall this app?". Confirm **OK** and the app will be removed from all users on the device.

Note:

- If you don't find the app that you want to remove on the home page, you can press **⊕** > **Settings** > **Apps** > **See all apps**.

Apps Settings and Permissions

You can find all the apps on the TV at **⊕** > **Settings** > **Apps** > **See all apps**.

Select the app, you can see the app's **Version**, **Storage used**, or you can **Open**, **Uninstall/Force stop**, **Uninstall updates**, **Disable**, etc.

Benefits of Smart TV

Clear data

 > **Settings** > **Apps**, select the app, then select **Clear data**.

All this app's data will be deleted permanently. This includes all files, settings, accounts, databases, etc.

Clear cache

Clear cache of applications and system.

Clear defaults

Clear defaults for apps.

Permissions

You can turn on or off the Location, and if you turn on **Remove permissions if app isn't used**, you can protect your data, permissions for this app will be removed if the app is unused for a few months.

Enhanced Viewing

Press  button on your remote control to select **Settings** > **System** > **Advanced System** > **Enhanced Viewing**

You can turn on Enhanced Viewing features to enhance viewing experience.

This function may not be applicable in some models/countries/regions.

Automatic Content Recognition

Provide picture quality and audio quality adjustment for the current content.

This function may not be applicable in some models/countries/regions.

To use this function, you should accept End User License Agreement and smart feature privacy policy/terms and conditions.

You will see the other Enhanced Viewing settings change from a greyed out state to highlighted. When this occurs, **Picture Mode Auto Adaptation** and **Sound Mode Auto Adaptation** features will be enabled.

Picture Mode Auto Adaptation

Automatically switch to the best picture mode for the current content.

This function may not be applicable in some models/countries/regions.

Sound Mode Auto Adaptation

Automatically switch to the best sound mode for the current content.

This function may not be applicable in some models/countries/regions.



Connecting to External Devices

Remote & Accessories

Connect remote controls or other accessories, such as keyboard, mouse and gamepad, to interact with your Smart TV easily.

Connect Remote Control

Pair the Bluetooth remote control with the TV.

1. To pair the Bluetooth remote control to the TV after you power the TV on for the first time, there will be instructions on how to pair the remote control.
2. If your remote control fails to pair with TV, keep the remote control within 10 feet (304.8 cm) from the TV, hold  and  at the same time at least 3 seconds to start pairing until you see the light pulsing on the remote control.

Note:

- If your remote control fails to pair with TV, check the **Bluetooth** is set **On** by pressing  button to select **Settings > Remotes & Accessories > Bluetooth to On**.
- This function may not be applicable in some models/countries/regions.
- If an error occurred while trying to pair the remote control, it could have been caused by interference. Try to remove what is causing the interference and try pairing again.
- If an error occurred with the remote control while using sufficiently charged batteries, you can take out the batteries for 1~2 seconds then insert them back again. Now the remote control will work normally.
- The remote control cannot be paired to the TV while the TV is in standby mode.

Use HDMI&CEC

Use the TV's remote to control external devices that are connected to the TV by an HDMI cable. The external devices need to support HDMI&CEC function.

Connecting an external device through HDMI&CEC function

Press  button to select **Settings > Channels & Inputs > Inputs > HDMI control**.

1. Set **HDMI control** to On.
2. Connect an HDMI&CEC compliant device to the TV.
3. Turn on the connected external device. The device is automatically connected to the TV. After connection is finished, you can access the menu of the connected device on your TV screen using your TV remote control and control the device.

Enabling device auto power off

Press  button to select **Settings > Channels & Inputs > Inputs > Device auto power off**.

Set to On to turn off CEC compatible external devices when the TV is turned off.

Enabling TV auto power on

Press  button to select **Settings > Channels & Inputs > Inputs > TV auto power on**.

Set to On to turn on the TV when CEC compatible external devices is turned on.

Connecting to External Devices

HDMI format function

In HDMI source, press  /  button to select **HDMI Format**.

Please select **Enhanced format** if your HDMI device supports 4K HDR. If it does not support 4K HDR, please select **Standard format**.

Note:

- HDMI cables must be used to connect HDMI & CEC compatible devices to your TV.
- The HDMI & CEC feature of the connected device must be turned on.
- If you connect an HDMI device that is not HDMI & CEC compatible, all the HDMI & CEC control features do not work.
- Depending on the connected HDMI device, the HDMI & CEC control feature may not work.
- The HDMI & CEC feature supports One Touch Play, Routing Control, System Standby, Device OSD Name Transfer, Remote Control Pass Through, Give Device Power Status, System Audio Control.

Related information

[HDMI & CEC Issues](#) on page 59

Control the TV with a Keyboard, Mouse or Gamepad

Connect a keyboard, mouse or gamepad to control your TV easily.

Connect a USB keyboard, mouse or gamepad

Plug the keyboard, mouse or gamepad cable into the USB port of your TV.

Connect a Bluetooth keyboard, mouse or gamepad

Find the Bluetooth device name in **Settings > Remotes & Accessories** and select it.

Note:

- Keyboard, mouse, or gamepad connected via USB or Bluetooth technology may not be usable with some Apps.
- Bluetooth function may not be supported depending on the models/countries/regions.
- For more information about how to connect a Bluetooth device, refer to the Bluetooth device's user manual.

Related information

[Connecting a Bluetooth Device](#) on page 22

Connecting Bluetooth Devices

You can connect to devices using Bluetooth technology.

Turn on Bluetooth Feature on your TV

Press  button to select **Settings > Remotes & Accessories > Bluetooth Visibility** to **On**.

Connecting a Bluetooth Device

To pair a Bluetooth device, such as Bluetooth headphones, speakers, keyboards, mouse or even mobile devices:

Connecting to External Devices

1. Before pairing your Bluetooth devices, make sure they're in pairing mode and put devices within range of the TV. To put your Bluetooth devices in pairing mode, refer to the user manual of devices.
2. Press  button to select **Settings > Remotes & Accessories > Pair accessory** to put the TV in pairing mode. A list of available Bluetooth devices will be displayed.
3. Select the desired device from the list, then follow the onscreen instructions. If you are prompted to enter a passcode, refer to the user manual of the device. After pairing is completed, the device is connected and is stored to the TV.

Note:

- You need to unpair a paired device first if the maximum number of paired devices was reached.

Note:

- One Bluetooth speaker or Bluetooth headphone can be connected to the TV all the time, also you can select HeadPhone Only.
- Some compatibility issues may occur depending on the Bluetooth device support.
- Bluetooth keyboards may not be functional with some applications.
- The TV and Bluetooth devices may become disconnected if the distance between them is too long.
- This function may not be applicable in some models/countries/regions.

Related information

[Headphone Settings Setup](#)

Listen to the Audio through Bluetooth Devices

1. Pair the Bluetooth audio devices using the TV's Bluetooth function. Refer to the user manual of your audio device such as Bluetooth speaker, sound bar and headphones for detailed connection steps and usage.
2. Press  button on your remote control to select **Settings > Display & Sound > Audio Output > Audio Output**, and then select the **Bluetooth** option to listen to the audio through bluetooth devices.

Note:

- Compatibility issues may occur depending on the Bluetooth device.
- The TV and Bluetooth devices may become disconnected if the distance between them is too long.
- This function may not be applicable in some models/countries/regions.

Sharing your Smart Phone/Computer Screen on the TV

Mirror content from your mobile device to the TV. View videos, photos and more from your device on your TV screen.

Press  button to select **Apps**, and select **Screen Sharing** or  > **Settings > Apps > Screen Sharing**.

1. Connect your mobile device to the WLAN network.
2. Turn on the casting function of your Android/Windows10 device. The function name and location will be different according to your device. The feature may be called "Wireless display", "Smart view", "Wireless projection", etc.
3. Find the TV name in the searching list of your device and select it to connect to your TV. Your mobile device's screen will be mirrored once you select your TV. You can close Screen sharing application with BACK or EXIT button.

Note:

Connecting to External Devices

- Some mobile devices may not support casting feature.

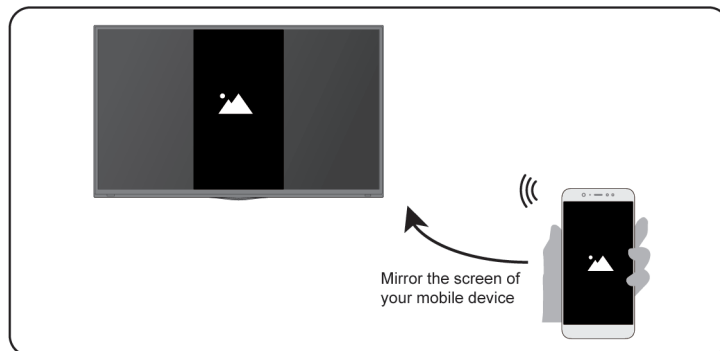

Related information

[Connect to a Wireless Network](#) on page 4

Using AirPlay and HomeKit

Note:



- This function may not be applicable in some models/countries/regions.
- Use of the Works with Apple badge means that an accessory has been designed to work specifically with the technology identified in the badge and has been certified by the developer to meet Apple performance standards. Apple is not responsible for the operation of this device or its compliance with safety and regulatory standards.

Using Airplay

Use AirPlay to wirelessly share audio and video content from your iPhone, iPad, or Mac to your TV. Stream music and videos, share your photos, or mirror exactly what's on your device's screen.

AirPlay is a source in Inputs. Press the  button on your remote control to show the input list, then select AirPlay to enter AirPlay. Then you can select AirPlay and HomeKit Settings. You can also find AirPlay and HomeKit settings in system settings on your TV.

How to use AirPlay:

1. Make sure your Apple device is connected to the same network as your TV.
2. Locate the AirPlay icon on supported media apps, or the Screen Mirroring icon in Control Center on your Apple device. Depending on the content, these steps may vary:
 - To mirror your device's screen, open Control Center and tap Screen Mirroring .
 - To stream audio from supported music or podcast apps, tap AirPlay audio .
 - To stream video from supported apps, tap AirPlay video .
3. Select your TV from the list to begin using AirPlay.

Note:

- An AirPlay-enabled TV.
- The TV and Apple devices are connected to the same network.
- The icon is only for reference. In some apps, you may have to tap another icon first.

Connecting to External Devices

- If an AirPlay passcode appears on your TV screen, enter the passcode on your Apple device to continue.

Using HomeKit

Use HomeKit to easily and securely control your TV using your Apple devices.

1. To set up HomeKit, open AirPlay and HomeKit settings on the TV. Locate the HomeKit section and select 'Set Up'.
2. The HomeKit setup screen will display a pairing QR code on the TV. Use your iPhone or iPad to scan the QR code, then follow the on-screen directions to complete HomeKit setup.

Note:

- Available operations vary depending on the version of the app and software.

Connecting USB Devices

Connect the USB devices such as hard drives, USB sticks and digital cameras for browsing photos, listening to music.

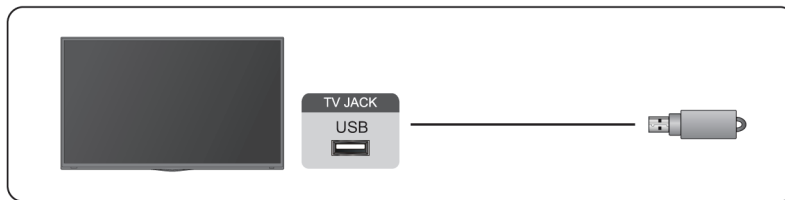

- Support the USB disk 4G, 8G, 16G, 32G, 64G, 128G and other common market size, and 8T hard drive is currently supported.
- Support format: NTFS, FAT32.
- Certain digital cameras may not be compatible with the TV.

Select the content you want to play or view. For more information, please refer to [Entertainment > Media](#) in this manual.

Connecting Headphones

You can connect a pair of headphones (not provided) to the HEADPHONE port on your TV. While the headphone is connected, the sound from the built-in speakers will be disabled.

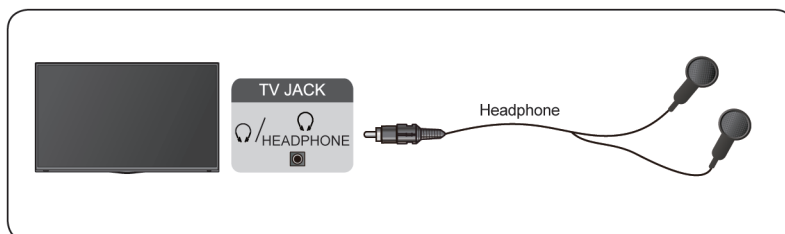

Note:

- Headphone port may not be available in some models.

Connecting to External Devices

- Headphones with microphones are not supported.
- If **Headphone with Speakers** is selected in **Settings > Display & Sound > Audio Output > Headphone Mode**, the headphone and the TV will have sound output at the same time.

Related information

[Headphone Settings Setup](#)

Connecting Audio Visual (AV) Devices

Connect with a composite video cable

To connect an AV device with a composite video cable (not provided), see the illustration below.

When the connection is completed, using your remote control, press **INPUT** button and select **AV** as the input source.

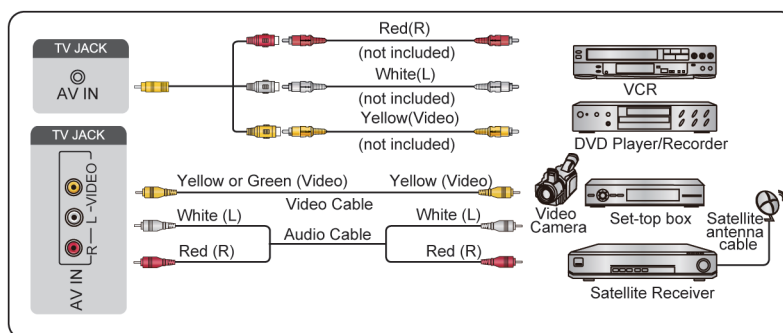

Note:

- AV IN port(s) may vary depending on model type.
- AV IN port(s) may not be available in some models. Please use other port(s) to connect AV devices.

Connect with a HDMI cable

To connect an AV device with a HDMI cable (not provided), see the illustration below.

When the connection is completed, using your remote control, press **INPUT** button, and select the corresponding HDMI input.

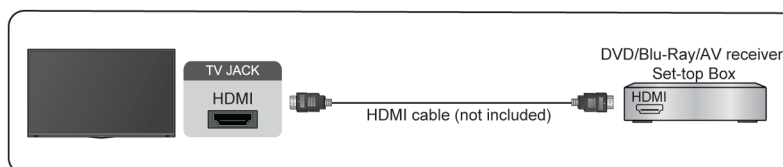

Note:

- Please refer to the User Manual of your device for step-by-step instructions.
- Some devices, such as DVD players, require the HDMI signal to be set to the correct format in the device settings. Please consult your device user manual for instructions.

Connecting to External Devices

- If there is no sound from your TV, configure the device audio settings.

Related information

[Use HDMI&CEC](#) on page 21

Connecting Speakers or Other Audio Receivers

To connect speakers or other audio receivers with an audio cable (not provided), see the illustration below.

Ensure the audio connected devices are switched on before switching on the TV.

When a digital audio system is connected to the DIGITAL AUDIO OUT port, decrease the TV volume, and use your digital audio system to control the volume.

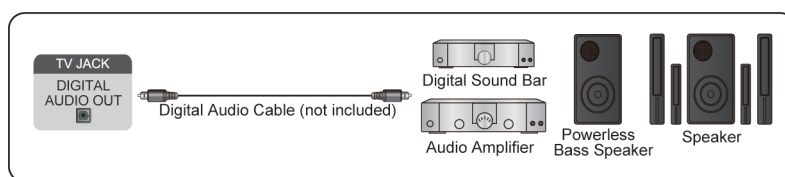

Note:

- If you prefer to use Audio Return Channel/Enhanced Audio Return Channel, please refer to [Connecting to External Devices > Connecting a Digital Audio System with ARC](#) in this manual.
- You can connect the DIGITAL AUDIO OUT port on the back of the TV to the optical port on the amplifier. Then go to  > **Settings** > **Display & Sound** > **Audio Output** > **Digital Audio Out** to choose to select **Dolby Audio - Dolby Digital** to receive the Dolby Digital audio.

Related information

[Select Speakers](#) on page 36

Connecting a Digital Audio System with ARC/eARC

If you would like to use the Audio Return Channel (ARC) or enhanced Audio Return Channel (eARC) feature to send sound from the TV by a HDMI cable to a digital sound system, you can connect it to the HDMI (ARC/eARC) port of your TV.

By using this feature, you can also control the sound system with your TV remote instead of using the remotes for each device.

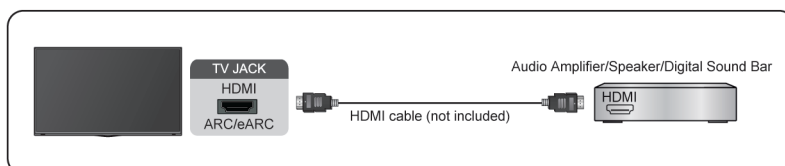

After the connection:

1. Power on the sound system.
2. If the device supports eARC function, press  button on your remote control to select **Settings** > **Display & Sound** > **Audio Output** > **eARC**.

Connecting to External Devices

Note:

- Audio receiver must support ARC function.
- If the device has an Input Selector feature, then make sure to change it to TV.
- When this port is used for ARC function, it can be used as signal input when a DVD is connected to an amplifier and the amplifier is connected to the TV at the same time. Some amplifiers may not support series connection.
- 5.1 CH (channel) audio is available when the TV is connected to an external device that supports 5.1 channel surround sound. You can press  button on your remote control to select **Settings > Display & Sound > Audio Output > Digital Audio Out** to choose **Dolby Audio - Dolby Digital Plus** to receive the 5.1 channel audio.

Related information

[Select Speakers](#) on page 36

Connecting a PC

You can connect a PC to the TV with a HDMI cable to use your TV as a PC monitor.

After connecting the PC, press  button. Select the connected PC as the input source.

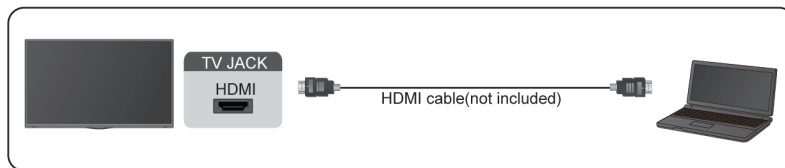

Note:

- For better image quality, set the PC's resolution, and make sure the resolution is supported by the TV.
- If there is no sound from your TV, change the PC's audio settings.
- If you want to connect your PC and TV wirelessly, please refer to [Benefits of Smart TV > Content Sharing](#) or [Connecting to External Devices > Sharing your Smart Phone/Computer Screen on the TV](#) in this manual.

Settings Overview

Picture

Adjust picture general settings and other advanced picture settings.

General Settings

Press  button on your remote control to select **Settings > Display & Sound > Picture > General**.

Choose a picture mode

Press  button on your remote control to select **Settings > Display & Sound > Picture > General > Picture Mode**.

You can select the picture mode that provides the best viewing experience.

Note:

- Options may differ depending on your model/country/region and the content you are watching. Please refer to the specific product.

When you use a normal signal

If you would like to configure the settings for your picture, then there are some types of picture modes available:

- **Vivid(Dynamic)**
You can enjoy vivid experience.
- **Standard**
Use Standard mode for watching normal content, such as News, Drama or Documentaries.
- **Energy Saving**
Energy Saving mode can save energy.
- **Game**
Enable Game Mode to optimize the TV's settings to enjoy a better gaming experience with a PC or a game console connected to the TV.
- **Sports**
Optimized picture for watching sports.
- **Theater Day**
Theater Day corresponds to the quality effect of different ambient brightness scenes.
- **Theater Night**
Theater Night corresponds to the quality effect of different ambient brightness scenes.
- **Auto Mode**
The picture mode will be adjusted automatically.
- **FILMMAKER MODE**
A picture quality mode.

Note:

- Auto Mode may not be applicable in some models/countries/regions.
- The Game mode can't be used in tuner and USB source.

Settings Overview

When you use a HDR signal

HDR (high dynamic range) can improve the viewing experience with higher contrast and vivid colors. Bright whites look brighter and dark blacks look darker. TV can display a wide range of colors.

Note:

- When you use a HDR signal, the picture mode is HDR picture mode.

When you use a Dolby Vision signal

Inspired by cinema technology, Dolby Vision is the format that allows your TV to deliver a full range of colors, high dynamic range images, brighter whites and dark blacks using scene-by-scene calibration.

Note:

- When you use a Dolby Vision signal, the picture mode is Dolby Vision picture mode.

Apply Picture Settings

Press  button on your remote control to select **Settings > Display & Sound > Picture > General > Apply Picture Settings**.

Adjust current picture mode to apply to all sources (Including both external devices and OTT sources) or just current source.

Intelligent Scene

Recognized the scene in the content user watching and enhance the picture quality.

Note:

- Intelligent Scene may not be applicable in some models/countries/regions.

Automatic Light Sensor

Enable the TV to automatically adjust the picture settings according to the amount of ambient light in your room.

Automatic Light Sensor

You can turn on or off the Automatic Light Sensor.

Light Sensor Shift

Adjust the lower point of the dynamic backlight adjustment scope. This is a money-saving feature because it reduces power consumption.

If you set Automatic Light Sensor to be Off, The Light Sensor Shift menu can't be selected.

Content Type Auto Detection

A picture quality mode, which can automatically switch according to the film source if you turn on.

Enhanced Viewing Angle

Set to On to optimize your viewing angle, and you will enjoy a better watching experience.

This function may not be applicable in some models/countries/regions.

Related information

[Picture Issues](#) on page 56

Settings Overview

Use the Brightness function

Press  button on your remote control to select **Settings > Display & Sound > Picture > Brightness**.

You can configure picture mode settings that provides the best viewing experience. Options may not be applicable depending on your model/country/region and the picture mode you selected.

- **Dynamic Backlight Control (or Local Dimming if support)**
Enable the TV to automatically adjust the backlight by sections according to the changes in the image and increase the contrast.
- **Brightness**
Adjust the Brightness level to generate lighter or darker images.
- **Contrast**
Adjust the Contrast level to increase or decrease how bright images appear.
- **Black Level**
Adjust the HDMI Level to enhance current content.
- **Dark Detail**
Enhance the dark details by analysing the luminance level of the signal in real time.
- **Gamma**
Adjust the Gamma to alter how the TV will respond to the grayscale content. In a dark room choose a Higher number like 2.2. In a brighter area select a Lower number like 2.0. In general, 2.4 is normally recommended.
- **Active Contrast**
Automatically darken dark areas and lighten light areas of images to see more details.
- **Dynamic Tone Mapping**
Automatically adjust brightness and gradient balance by analysing the brightness level of HDR content.
This function may not be applicable in some models/countries/regions and only be visible when in HDR mode.
- **HDMI Dynamic Range**
Adjust the HDMI signal range to be more suitable for the content. (HDMI mode only)
- **Low Blue Light**
Eye care: reduce the emission of blue light.
This function may not be applicable in some models/countries/regions.

Adjust the picture quality for each picture mode

Press  button on your remote control to select **Settings > Display & Sound > Picture > Color/Clarity**.

- **Color**
Adjust the color intensity of the picture for a more vibrant image.
- **Hue**
Adjust the hue of the picture.
- **Color Temperature**
Adjust how warm (red) or cool (blue) the white areas of an image appears.

Settings Overview

- **Color Space**

Change the range of colors the TV displays.

- **Sharpness**

Adjust how sharp or soft edges of images appear.

- **Super Resolution**

Enhance image detail, eliminate image edge jaggling, and adjust dynamically according to the image content.

- **Smooth Gradient**

Eliminates image layering and dark field noise.

- **Noise Reduction**

Improve how clear the picture appears by reducing noise.

- **MPEG Noise Reduction**

Reduce MPEG block noise to provide clearer edge transitions.

- **Motion Enhancement**

Reduce seeing afterimages that are left on the screen when viewing fast-moving objects.

If you select **Custom**, you can configure **Blur Reduction** and **Judder Reduction** manually.

- **Motion Clearness**

Improve how clear the picture appears when viewing.

Configure Calibration Settings

Press  button on your remote control to select **Settings > Display & Sound > Picture > Calibration Settings**.

- **Color Tuner**

Adjust the Color, Hue, Saturation and Brightness of color settings.

- **White Balance**

Adjust the intensity of red, green and blue lights to view the true colors of all images in the picture.

- **Gamma Calibration**

Adjust selected Gamma curve.

- **RGB Only**

View images based on default settings or choose the color red, blue or green.

- **Calman Service**

Adjust the picture quality of the TV by a Calman client on PC.

Reset the picture settings

Press  button on your remote control to select **Settings > Display & Sound > Picture > Reset**.

Reset current picture settings back to the factory setting.

Screen

Change the picture size and use the overscan function.

Settings Overview

Note:

- This function may vary depending on the version of the software.

Change the Picture Size

Press  button on your remote control to select **Settings > Display & Sound > Screen > Picture Size**.

You can adjust the Aspect Ratio to stretch or zoom the picture.

You can choose from the following settings: **Auto, Normal, Zoom, Wide, Direct, Dot-By-Dot, 21:9** or **32:9**.

Related information

[Picture Issues](#) on page 56

Use the Overscan function

Press  button on your remote control to select **Settings > Display & Sound > Screen > Overscan**.

Change the video size settings to slightly crop the edges of the displayed image.

Sound

Adjust sound mode and other advanced sound settings.

Choose a Sound Mode

Press  button on your remote control to select **Settings > Display & Sound > Sound > Sound Mode**.

You can select a preset sound mode suitable for the content type or the listening environment.

- **Standard**

In Standard mode, the TV delivers a flat frequency response, which preserves the natural characteristics of the original sound.

- **Theater**

Theater mode increases the surround sound effect and provides a more prominent bass response.

- **Sports**

Optimized sound for watching Sports events.

- **Music**

In Music mode, low and high frequencies are emphasised to enhance musical instrument reproduction.

- **Speech**

In Speech mode, low and high frequencies are attenuated to improve the reproduction and clarity of the human voice.

- **Late Night**

In Late Night mode, the TV will improve the reproduction and clarity of the human voice with a low volume level.

- **Intelligent Sound**

When the Intelligent Sound is on, the TV recognizes the sound and enhances the sound quality.

- **Auto Mode**

The sound mode will be adjusted automatically.

Settings Overview

Note:

- Auto Mode may not be applicable in some models/countries/regions.
- Sound mode adjustment is only available when you select TV speaker as audio output.

Related information

[Sound Issues](#) on page 57

Adjust the Sound Quality

Enable TruBass HDX

Press  button on your remote control to select **Settings > Display & Sound > Sound > TruBass HDX**.

Optimizes overall sound quality by increasing bass, making dialog clear and natural, and widening the sound field.

Enable TruSurround: X

Press  button on your remote control to select **Settings > Display & Sound > Sound > TruSurround: X**.

Provides surround sound experience with psycho-acoustic processing to place sounds beside, behind, and above the viewer. For best results use with Surround Sound.

Enable Dialog Clarity

Press  button on your remote control to select **Settings > Display & Sound > Sound > Dialog Clarity** to improve dialog clarity.

Enable TruVolume HD

Press  button on your remote control to select **Settings > Display & Sound > Sound > TruVolume HD**.

Maintains consistent loudness levels from wide dynamic range programs, loud commercials, and channel or input changes.

Enable Dolby Atmos

Press  button on your remote control to select **Settings > Display & Sound > Sound > Dolby Atmos**.

Set Dolby Atmos to On to enhance the richness of sound, and you can enjoy an immersive listening experience.

Note:

- The above functions are based on sound mode, if Speakers = TV speaker, these functions can be used.

Subwoofer

The switch needs to be turned on when the subwoofer is connected to the TV.

Bass Boost

Hear and feel rich bass response with the TV's subwoofer speaker.

This function may not be applicable in some models/countries/regions.

Settings Overview

Enable Wall Mount Setup

Press  button on your remote control to select **Settings > Display & Sound > Sound > Wall Mount Setup**.

Automatically optimize the sound based on the position of the TV.

Wall Mount Setup is only available when you select TV speaker as audio output.

Auto Acoustic Tuning

Optimise the sound output acoustics according to the listening environment.

Note:

- The menu may vary, depending on the actual display of the TV.

Related information

[Sound Issues](#) on page 57

Configure Advanced Settings

Press  button on your remote control to select **Settings > Display & Sound > Sound > Advanced Settings**.

Tune the audio settings and quality of the TV.

Balance

Adjust the left and right speaker strength to optimize audio for a specific location.

Volume Level

Balance the sound volume of each source.

Auto Volume Control

Activate to prevent the volume from changing when you switch TV channels.

Lip Sync

Synchronize the displayed image with the audio output.

Equalizer

Boost the volume at different frequencies.

Resetting the sound settings

Press  button on your remote control to select **Settings > Display & Sound > Sound > Reset**.

Reset current audio settings to factory mode.

Audio Output

Select speakers and adjust the audio output settings.

Note:

- This function may vary depending on the version of the software.

Settings Overview

Select Speakers

Press  button on your remote control to select **Settings > Display & Sound > Audio Output > Audio Output Selection**.

Select the speakers which you want to use.

Configuring WiSA Speaker Settings

Press  button on your remote control to select **Settings > Display & Sound > Audio Output > WiSA Speaker Settings**.

Wireless audio transmission can be available with Dongle provided by WiSA Ready and sound system certified by WiSA Ready.

Note:

- WiSA Speaker Settings may not be applicable in some models/countries/regions.

Related information

[Connecting Speakers or Other Audio Receivers](#) on page 27

[Connecting a Digital Audio System with ARC](#) on page 27

Adjust the Audio Output settings

Enable eARC

Press  button on your remote control to select **Settings > Display & Sound > Audio Output > eARC**.

Connect an audio device that supports eARC via HDMI-eARC, and set eARC to on to enjoy premium sound quality.

Digital Audio Out

Select the digital audio output format that best suits the audio device type.

Note:

- When using optical connection, PCM and Dolby Digital are suggested.
- If your external audio device does not support Dolby or DTS, PCM is suggested.

Digital Audio Delay

Adjust the digital audio output delay time to sync sound from an external speaker with the images on the TV.

Note:

- Digital Audio Out and Digital Audio Delay functions are only applicable when Audio Output is set to ARC or when external audio players are connected via DIGITAL AUDIO OUT jack.

Headphone Settings Setup

Set the sound output mode through headphones.

After connecting your wired or Bluetooth headphone, or other external audio amplifiers, you can set up your TV to your preference.

Note:

- This function may not be applicable in some models/countries/regions.

Settings Overview

- **Headphone Mode**
Change the way audio is sent through the type of device that's connected to your TV Audio Out port.
- **Headphone Volume**
Independently adjust the volume of wired headphones.

Related information

- [Connecting Bluetooth Devices](#) on page 22
- [Connecting Headphones](#) on page 25
- [Connecting Speakers or Other Audio Receivers](#) on page 27
- [Connecting a Digital Audio System with ARC](#) on page 27

Network & Internet

You can connect to the internet with Wi-Fi, ethernet, or your phones hotspot.

For additional information about Network & Internet, please refer to [First Time Use > Connecting to the Internet](#) in this manual.

Scanning always available

Press  button on your remote control to select **Settings > Network & Internet > Scanning always available**.

Let Google's location service and other apps scan for networks, even when Wi-Fi is off.

Related information

- [My TV cannot connect to the network.](#) on page 52
- [Connect to a Wired \(Ethernet\) Network](#) on page 3
- [Connect to a Wireless Network](#) on page 4

General

You can set up system settings.

Note:

- The menus displayed vary depending on models/countries/regions.

Set Time

Press  button on your remote control to select **Settings > System > Date & Time**.

- **Automatic date & time**
Set to use network-provided time.
You can also set the current time manually when Off is selected.
When Off is selected, the TV Network may not be working properly.
- **Set date**
Set the date.
- **Set time**
Set the time.

Settings Overview

- **Set time zone**

Select your time zone.

- **Use 24-hour format**

Set the time to display in a 12 or 24-hour format.

Use Timer

Press  button on your remote control to select **Settings > System > Power & Energy > Power**.

- **Sleep Timer**

Set the sleep timer to automatically turn the TV off within a specified time: off, 10 Minutes, 20 Minutes, 30 Minutes, 40 Minutes, 50 Minutes, 60 Minutes, 90 Minutes and 120 Minutes.

- **Power On Timer Type**

Set the type: Off, Daily, Once.

- Power On Timer

Set the clock for the time you want the TV to turn on automatically.

- **Power Off Timer Type**

Set the type: Off, Daily, Once.

- Power Off Timer

Set the clock for the time you want the TV to turn off automatically.

Set Language

Press  button on your remote control to select **Settings > System > Language**.

Adjust the default Language settings for the TV.

Configure Device Preferences Settings

Keyboard

Press  button on your remote control to select **Settings > System > Keyboard**.

Adjust the default settings for the keyboard.

Storage

Press  button on your remote control to select **Settings > System > Storage**.

View the TV storage.

Ambient mode

Press  button on your remote control to select **Settings > System > Ambient mode**.

Activate a screensaver when your TV displays a still image for a period of time. Set the time according to your preference.

Power & Energy

Press  button on your remote control to select **Settings > System > Power & Energy**.

Settings Overview

Power on behavior

Select the screen to start when powering on the TV.

You can select **Home screen** or **Last input**.

Energy saver

Turn off display after 15 minutes, 30 minutes, 1 hour, 4 hours, 8 hours, 12 hours, 24 hours, Never.

Power

You can set **Power LED** ON or OFF, set **Power On Mode** to **Remember**, **Standby**, **On**, **Sleep Timer**, **Auto Sleep**, and **Power On Timer Type**.

System sounds

Press  button on your remote control to select **Settings > System > System sounds**.

This is a switch for system sounds.

Camera Smart Functions

Press  button on your remote control to select **Settings > System > Camera Smart Functions**.

Enjoy smart TV experience by connecting a camera.

Related information

[Use Timer](#) on page 38

Configure Advanced System Settings

Press  button on your remote control to select **Settings > System > Advanced System**.

Screenless Mode

If your models support Hands-free Voice Control function, when the Screenless Mode is set to Off, the Google Assistant will not be available when the screen is off, you also will not be able to remotely wake up the TV through external devices. In screenless Mode, the Google Assistant is always available to help even when the screen is not on. Just say "OK Google/Hey Google".

This feature will affect standby power consumption when it is set to On.

Note:

- The Google Assistant and some features are available on limited country/region/language.
- This function may not be applicable in some models.

Wake on Cast

You can enable or disable Wake on Cast function which is able to remotely wake up the TV through external devices.

Note:

- This function may not be applicable in some models/countries/regions.

Product Registration

Visit <https://www.hisense-usa.com/support/register> or scan the QR code with another device (cellphone, tablet..) to complete your registration.

Note:

Settings Overview

- The website and the QR code may be different in some countries/regions.

E-Manual

Scan QR code to display E-Manual.

[Using the E-Manual](#)

Clear Cache

Clear cache of applications and system.

System message

You can set up support settings.

Note:

- The menus displayed vary depending on models/countries/regions.

System message

Press  button on your remote control to select **Settings > System > Advanced System > Help > System message**.

View system message, including: Serial Number, Service Code, Software Version, etc.

Support information

Press  button on your remote control to select **Settings > System > Advanced System > Help > Support information**.

View Support URL, Support Number, Email, etc.

Signal Information

Press  button on your remote control to select **Settings > System > Advanced System > Help > Signal Information**.

Perform self diagnosis to test Video Format, Audio Format, Color Depth, etc.

Check Software Version

To check the current software version of your TV:

Press  button on your remote control to select **Settings > System > Advanced System > Help > System message**.

System Update

Press  button on your remote control to select **Settings > System > About > System update**.

Set your TV to receive the latest firmware. Provide software updates to continuously enhance your TV and correct any issues that may impact your user experience; therefore, recommend you to keep your TV connected to the Internet to automatically receive updates when they are available.

Settings Overview

Set Usage Mode

Set the TV to use in Home or Store mode.



Home Mode



Select Home Mode for normal TV usage.

If you want to switch to Store Mode when the TV is in Home Mode, turn on **Store Mode** at  > **Settings** > **System** > **Advanced System**.

Store Mode

Select Store Mode to setup the TV in a retail setting. This mode enables E-Pos and other demo functions and is only intended for use in retail stores.

When Store Mode is selected, press  /  button on your remote control to enter store mode settings.

If you want to switch to Home Mode when the TV is in Store Mode, press  /  button on your remote control to enter **Store Mode Settings** and choose **Home Mode**. Alternatively, turn off **Store Mode** at  > **Settings** > **System** > **Advanced System**.

Note:

- Enabling Store Mode could increase energy consumption.
- How to exit Store Mode varies depending on models/countries/regions.

Using Parental Control

Press  button to select **Settings** > **System** > **Advanced System** > **Parental Control**.

The Parental Control setting allows you to block content that is not appropriate for children to watch.

• Locks

Turning Parental Control On

1. Turn on Locks to enable the Parental Control function.
2. Create PIN window displays. Using the D-pad on your remote control, create the password.
3. You will see other Parental Control settings change from a greyed out state to highlighted. When this occurs, begin adding other settings to the **Scheduled Blocking**, **Channel Blocking**, **Program Blocking**, **Input Blocking**, **Change PIN** and **Reset** features.

• Scheduled Blocking

Block certain channels, programs and inputs during certain periods of time.

• Channel Blocking

Block selected channels.

• Program Blocking

Block programs by ratings.

• Input Blocking

Block selected inputs.

• Change PIN

Change the PIN that you use to access Parental Control.

Settings Overview

Note:

If you forget your password, call the Consumer Electronics Care Centre.

- **Reset**

Reset Parental Control back to the factory setting.

Reset to Factory Default

Press  button on your remote control to select **Settings > System > About > Reset > Factory reset**.

Restore your device to default settings and erase all data, accounts, files, and downloaded apps.



Game

You can connect to your game console and set up settings to optimize the TV screen for better gaming performance.

Connect a Game Console

You can connect your game console with a HDMI cable to the TV.

To start a game from a game console:

1. Switch on your game console.
2. Press  button on your remote control to select **Inputs** or press  button. Select the connected game console as the input source.
3. Start the game.

You can enable the game mode to optimize your TV's settings when playing games with a game console.

Related information

[Enabling game mode](#) on page 43

Enabling game mode

Press  button on your remote control to select **Settings > Display & Sound > Picture > General > Picture Mode > Game**.

Enable **Game Mode** to optimize the TV's settings to enjoy a better gaming experience with a PC or a game console connected to the TV.

Game Mode will allow:

- Reducing input lag to make sure every press or click matches what is happening on the screen;
- Improving responsiveness to produce very little motion blur;
- Processing YUV 4:4:4 format signals precisely to present accurate image colors.

Note:

- This function may not be applicable in some input sources or applications.

Related information

[Connect a Game Console](#) on page 43

Enabling instant game response

Press  button to select **Settings > Display & Sound > Game Settings > Instant Game Response**.

You can enjoy a smooth viewing experience with external device connected to the TV when **Instant Game Response** is turned on.

Note:

- When Game mode is selected, Instant Game Response will not be switched off automatically.

Enabling FreeSync/PC Sync

Press  button to select **Settings > Display & Sound > Game Settings > FreeSync/PC Sync**.

Entertainment

You can enjoy a smooth viewing experience with external device connected to the TV when **FreeSync/PC Sync** is turned on.

This function may not be applicable in some models/countries/regions.

Enabling High Refresh Rate Mode

Press  button to select **Settings > Display & Sound > Game Settings > High Refresh Rate Mode**.

Activation of the high refresh rate mode can improve the smoothness of the game screen.

This function may not be applicable in some models/countries/regions.

SoundBar Settings

When the soundbar device is connected to the TV, You can change the SoundBar Settings at Settings menu for best device sound quality.

When the ARC device is connected to the TV, the sound output is automatically switched to ARC, if the user switches to other sound output channels, the soundbar menu cannot be adjusted, and the sound menu of TV can be adjusted.

Press  button on your remote control to select **Settings > Display & Sound > Audio Output > SoundBar Settings**.

Note:

- When you connect a soundbar with an HDMI cable, you should set **HDMI control** to **On**.  > **Settings > Channels & Inputs > Inputs > HDMI control**.
- Some soundbar device can't support this function.
- **EQ Modes**
You can select **Music, Movie, News, Sport, Night**.
- **Surround Modes**
You can set to **On** to turn on the Surround Modes.
- **Bass Level/Treble Level/Dimmer Level**
You can adjust **Bass Level/Treble Level/Dimmer Level**.
- **Reset**
Reset current SoundBar Settings to factory mode.

Sports

Sports mode setup in picture or sound settings

Press  button on your remote control to select **Settings > Display & Sound > Picture > General > Picture Mode > Sports**.

Optimized picture for watching sports.

Press  button on your remote control to select **Settings > Display & Sound > Sound > Sound Mode > Sports**.

Optimized sound for watching sports events.

Media

Media is a central location for you to view or listen to different types of content, such as photos, music and movies. You can view media content through the following methods:



- A USB thumb drive or hard drive.
- Compatible mobile phone, tablet or other personal devices: you can stream movies, music and photos that are stored on compatible personal device and play or view the content on your TV.

By default, there is **Content Sharing** displayed on the Media screen. If your mobile device is connected to the TV, its name also appears on the Media screen.

For more information about **Content Sharing**, please refer to [Benefits of Smart TV > Content Sharing](#) in this manual.

Enjoy Photos/Audio/Video Stored on a USB Device

You have some ways to enter Media:

- Press  button to select **MediaCenter** from your Apps list on home page.
- Press  button to select **Settings > Apps > All Apps > MediaCenter > Open**.

Then select **connected devices**.

Select the content you want to play on the screen, like pictures, videos and music.

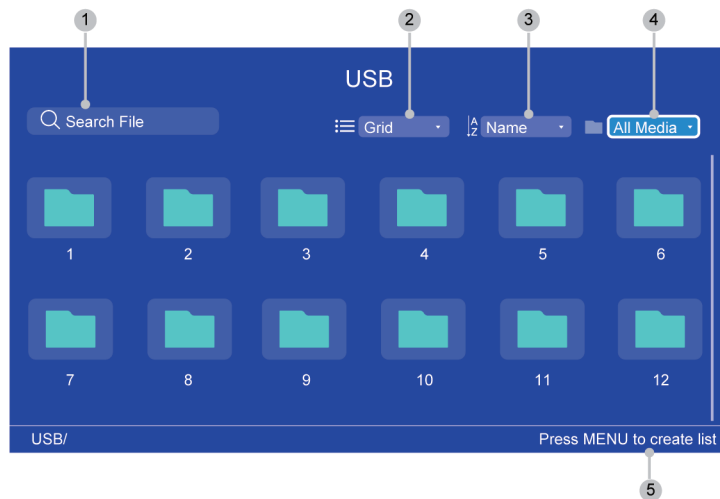

- 1 Search the content you want to play.
- 2 Arrange the content list by **Grid, List**.
- 3 Sort the content list by **Name, Date Modified, Size**.
- 4 Filter the content list by **All Media, Music, Photos, Videos**.
- 5 Create a photo, music, or video playlist.

Note:

Entertainment

- Some options in the above table may not be available in some models/countries/regions.
- The image is only for reference and may differ from the actual product.

Media format list

Due to differences in programming tools and other factors, some of the file formats that are listed may not be supported.

The listed formats may not be supported depending on the model.

Video Format

Container	Video Codec	File Extension Name	Resolution and Frame Rate
MPG	MPEG1	.mpg .mpeg	720 x 576 @ 30fps
MPEG program stream	MPEG2		3840 x 2160 @ 30fps
	MPEG1	.DAT, .VOB, .MPG, .MPEG	720 x 576 @ 30fps
	MPEG2		3840 x 2160 @ 30fps
	MPEG4		1920 x 1080 @ 60fps
	H.264		3840 x 2160 @ 60fps
MPEG transport stream	HEVC/H.265		.ts, .trp, .tp
	MPEG4	1920 x 1080 @ 60fps	
	H.264	3840 x 2160 @ 60fps	
	VC1	1920 x 1080 @ 60fps	
	MPEG1	720 x 576 @ 30fps	
	MPEG2	3840 x 2160 @ 30fps	
MP4	VP8	.mp4, .mov	1920 x 1080 @ 60fps
	AV1		3840 x 2160 @ 60fps
	HEVC/H.265		
	MPEG1		720 x 576 @ 30fps
	MPEG2		3840 x 2160 @ 30fps
	MPEG4		1920 x 1080 @ 60fps
	H.263		
	WMV3		
	VC1		
	H.264		3840 x 2160 @ 60fps
	Motion JPEG		1920 x 1080 @ 60fps
MKV	VP9	.mkv	3840 x 2160 @ 60fps
	HEVC/H.265		
	MPEG1		720 x 576 @ 30fps
	MPEG2		3840 x 2160 @ 30fps

Entertainment

Container	Video Codec	File Extension Name	Resolution and Frame Rate
	MPEG4		1920 x 1080 @ 60fps
	H.264		3840 x 2160 @ 60fps
	WMV3		1920 x 1080 @ 60fps
	VC1		
	Motion JPEG		
	VP8		
	AV1		3840 x 2160 @ 60fps
AVI	HEVC/H.265	.avi	3840 x 2160 @ 60fps
	MPEG1		720 x 576 @ 30fps
	MPEG2		3840 x 2160 @ 30fps
	MPEG4		1920 x 1080 @ 60fps
	Sorenson H.263		1920 x 1080 @ 60fps
	H.263		3840 x 2160 @ 60fps
	H.264		
	WMV3		1920 x 1080 @ 60fps
	VC1		
	Motion JPEG		
	VP8		
FLV	HEVC/H.265	.flv	3840 x 2160 @ 60fps
	MPEG4		1920 x 1080 @ 60fps
	H.263		3840 x 2160 @ 60fps
	H.264		
	Motion JPEG		1920 x 1080 @ 60fps
	VP8		1920 x 1080 @ 60fps
WEBM	VP9	.webm	3840 x 2160 @ 60fps
	VP8		1920 x 1080 @ 60fps
	AV1		3840 x 2160 @ 60fps

Audio Format

Container	Audio Codec	File Extension Name
WAV	MPEG1/2 Layer1	.wav
	MPEG1/2 Layer2	

Entertainment

Container	Audio Codec	File Extension Name
	MPEG1/2/2.5 Layer3	
	AAC-LC, HEAAC	
	DTS, DTS HD	
	LPCM	
MP3	MPEG1/2 Layer1	.mp3
	MPEG1/2 Layer2	
	MPEG1/2/2.5 Layer3	
AAC	AAC-LC, HEAAC	.aac
WMA	WMA7, WMA8, WMA9	.wma, .wmv
	WMA Pro	
	WMA9 Pro	
FLAC	FLAC	.flac

Photo Format

Image	Photo	Resolution
JPEG	.jpg .jpeg	65535 x 65535
	Progressive	1920 x 1080
PNG		8192 x 4320
BMP		
GIF		
WebP		3840 x 2160

THIS PRODUCT IS LICENSED UNDER THE AVC PATENT PORTFOLIO LICENSE FOR THE PERSONAL USE OF A CONSUMER OR OTHER USES IN WHICH IT DOES NOT RECEIVE REMUNERATION TO (i) ENCODE VIDEO IN COMPLIANCE WITH THE AVC STANDARD ("AVC VIDEO") AND/OR (ii) DECODE AVC VIDEO THAT WAS ENCODED BY A CONSUMER ENGAGED IN A PERSONAL ACTIVITY AND/OR WAS OBTAINED FROM A VIDEO PROVIDER LICENSED TO PROVIDE AVC VIDEO. NO LICENSE IS GRANTED OR SHALL BE IMPLIED FOR ANY OTHER USE. ADDITIONAL INFORMATION MAY BE OBTAINED FROM MPEG LA, L.L.C. SEE [HTTP://WWW.MPEGLA.COM](http://www.mpegla.com)

Accessibility Menu Setup

Press  button on your remote control to select **Settings > System > Accessibility**.

Accessibility function provides menu options and audio descriptions to aid the visually or hearing impaired.

Captions

Displays and sets the closed captions. You can set display options and select caption style.

- **Closed Captioning**
- **Captions**

High contrast text

Improves contrast for the visually impaired.

Text to speech

Let you specify text-to-speech engine details and speech rate.

Accessibility shortcut

When the shortcut is on, you can press both the back and down buttons for 3 seconds to start an accessibility feature.

TalkBack

Controls spoken feedback for visually impaired users.

Switch Access

Switch Access can collect all of the text you type, except passwords. This includes personal data such as credit card numbers.

CommonUI

CommonUI can collect all of the text you type, except passwords. This includes personal data such as credit card numbers.

Note:

- Some options in the above table may not be available in some models/countries/regions.
- The menu is only for reference and may differ from the actual product.

Related information

[Video Description](#) on page 12

Troubleshooting

FAQ

In this section you will find the answers to the most frequently asked questions.

Note:

- The images are only for reference and may differ from the actual product.

There is no picture, or the picture is black and white.

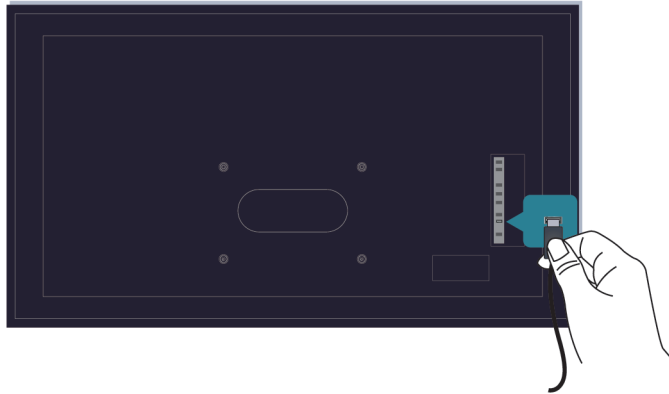

Check input cable connections.

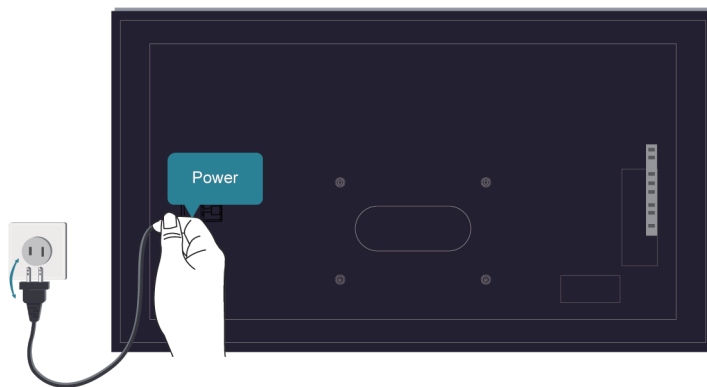

Unplug the TV power cord from AC outlet and re-plug after 60 seconds.

There is no sound or the sound is too low.

There is no sound or the sound is too low at maximum volume.

Troubleshooting

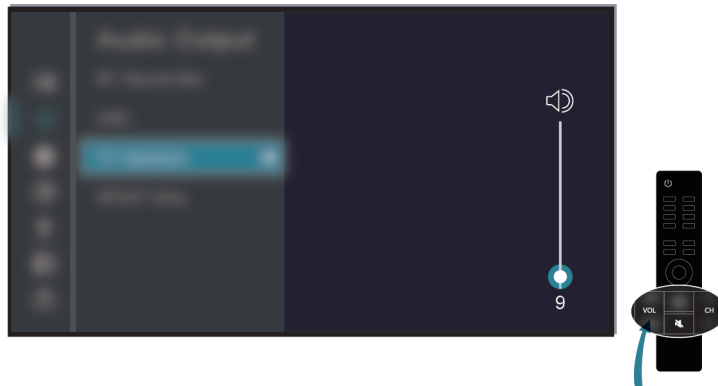

Check if Mute mode is set to on.

Check the volume settings.

Check the volume control of the device (cable or satellite box, DVD, Blu-ray, etc.) connected to your TV.

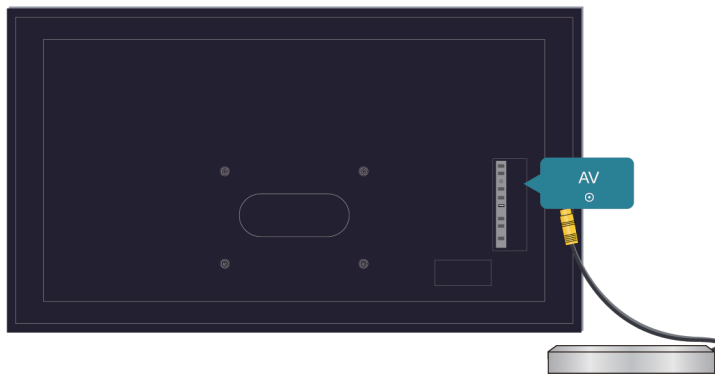

Make sure that the audio cable is connected to the correct audio output connector on the external device.

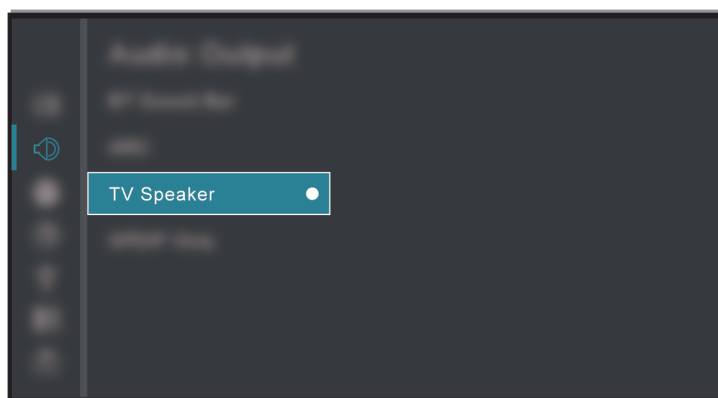

Troubleshooting

Check whether **TV Speaker** is selected at **⚙️ > Settings > Display & Sound > Audio Output > Audio Output**.

My TV cannot connect to the network.

Check network status at **⚙️ > Settings > System > About > Status**.

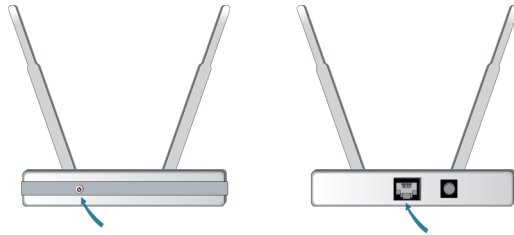

Make sure your modem/wireless router is on and connected to the Internet.

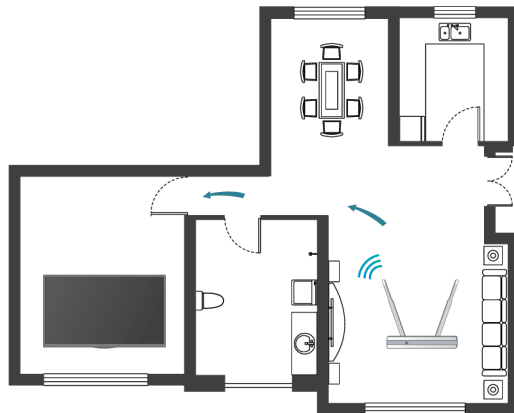

Position your wireless router, modem router, or access point in a central location. Avoid putting it in a corner.

External source connected but no picture or sound.

I have connected an external source to my TV but I get no picture and/or sound.

Troubleshooting

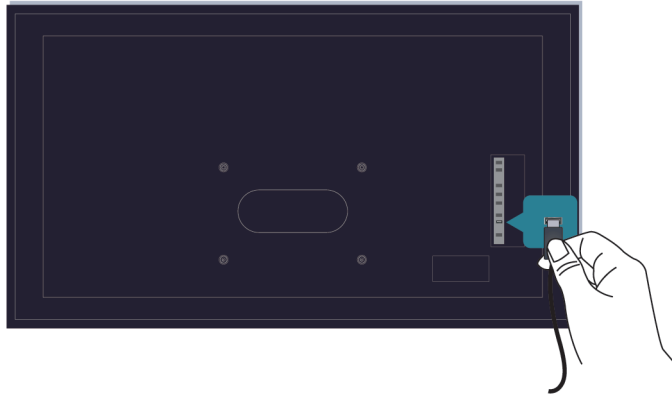

Check whether the connection between the external device and your TV is correct and secure.

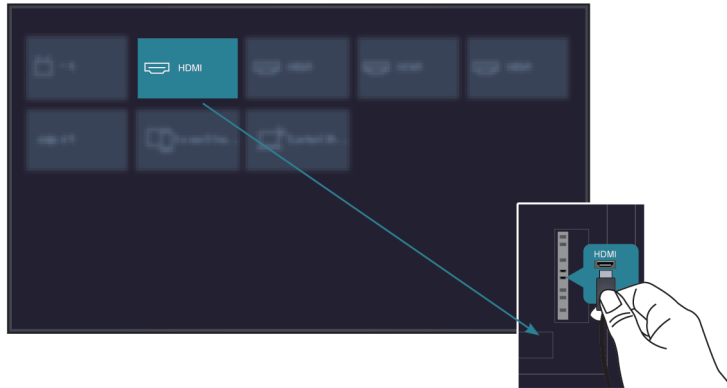

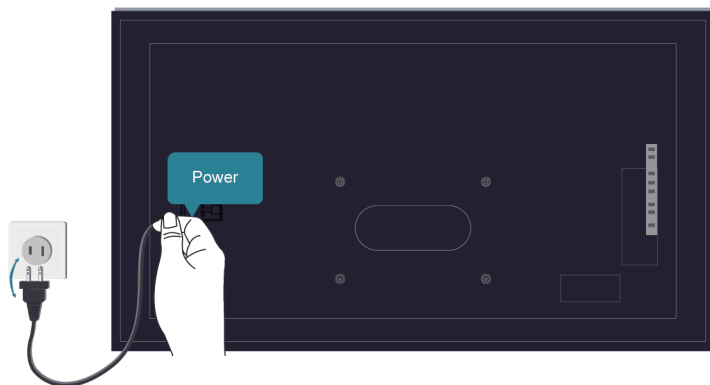

Make sure you have made the correct selection of input source.



If the signal is intermittent, unplug the TV power cord from AC outlet and re-plug after 60 seconds.

Troubleshooting

When devices are connected with HDMI cables

- If there is always no signal, or the signal cannot be restored after plugging and unplugging, you can press  /  button to select **HDMI Format** in HDMI source, to confirm whether the signal can be recognised.
- Change to another HDMI port.
- Change to another HDMI cable.

The remote control does not work.

Confirm that TV still has power and is operational. Press the power button on the TV to determine if the problem is with the remote control or not.



If the TV is not responding to the remote control, then please check if the small light on the remote control flashes when any button is pressed (some remote controls do not support this function).

If the small light does not flash when the remote control button is pressed, the battery power may be low, please replace the batteries with new ones.

Check that the orientation of each battery matches the positive (+) and negative (-) symbols in the battery compartment.





Keep the remote control sensor area clear from obstacles.

Troubleshooting

For Bluetooth remote controls



If the TV does not respond with the Bluetooth remote control, try pairing the remote control to the TV by pressing and holding the  and  button at the same time.

Schedule Recording cannot be used.

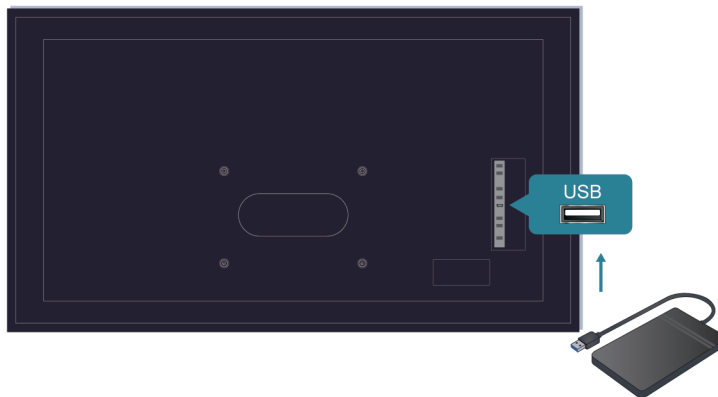

Check if there is a storage device connected to the TV.

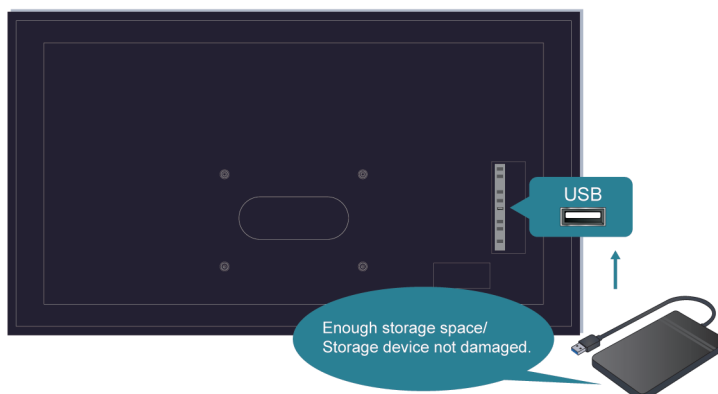

Troubleshooting

Check the free space of the storage device. The function will not work if there is not enough storage space on the device.

Check whether your storage device is damaged. If so, it is suggested to format your storage device.

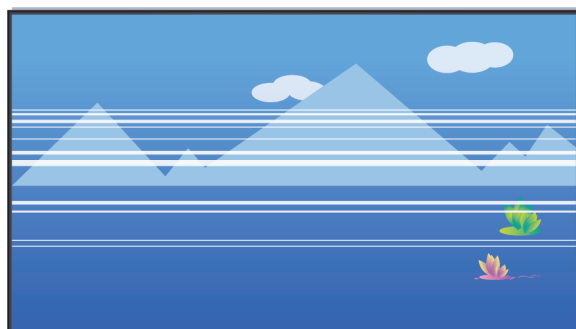



Recording will automatically stop if the signal becomes too weak.

Note:

- Recording function may not work if the read/write speed of the USB device is too slow.
- Recording function may not work because the storage format of your device is unsupported.
- The Recording functions may not be applicable in some models/countries/regions.

Picture Issues

When the TV has a picture problem, these steps may help resolve the problem.

Problems	Possible Solutions
<p>The picture is distorted.</p>	<ul style="list-style-type: none"> • The compression of video content may cause picture distortions, especially in fast moving pictures from sports programs and action movies. • If the signal reception is weak or poor, screen distortion may be visible but it is not a malfunction. • Mobile phones used close to the TV (within 1m) may cause noise on analogue and digital channels.
<p>The picture is blurry or flickering, or cuts out momentarily.</p>	<ul style="list-style-type: none"> •  > Settings > Display & Sound > Picture > Clarity > Sharpness. You can try to increase or decrease the Sharpness. • If you use an external antenna, check the direction, position and connection of the antenna. • Adjust the direction of your antenna, or reset or fine tune the channel.
<p>The picture appears red, purple, pink and other colors.</p>	<ul style="list-style-type: none"> •  > Settings > Display & Sound > Picture > Calibration Settings > White Balance. You can try to increase or decrease the White Balance.

Troubleshooting

Problems	Possible Solutions
Picture distorted or appears wavy.	<ul style="list-style-type: none">• Some electrical appliances may affect the TV. If you turn off the appliance and the interference goes away, then move it further away from TV.• Insert the power plug of the TV into another power outlet.

Related information

[There is no picture, or the picture is black and white.](#) on page 50

Sound Issues

When the TV has a sound problem, these steps may help resolve the problem.

Problems	Possible Solutions
Picture is normal, but no sound.	<ul style="list-style-type: none">• Check the volume settings.• Check if 'Mute' mode is set to on.• Check the volume control of the device (cable or satellite box, DVD, Blu-ray, etc.) connected to your TV.
The speakers are making an odd sound.	<ul style="list-style-type: none">• Make sure that the audio cable is connected to the correct audio output connector on the external device.• For antenna or cable connections, check the signal information.• A low signal level may cause sound distortions.
Sound distorted or appears wavy.	<ul style="list-style-type: none">• Some electrical appliances may affect the TV. If you turn off the appliance and the interference goes away, then move it further away from TV.• Insert the power plug of the TV set into another power outlet.
Sound is blurry or cuts out momentarily.	<ul style="list-style-type: none">• If you use an external antenna, check the direction, position and connection of the antenna.• Adjust the direction of your antenna or reset or fine tune the channel.

Note:

- This product does not support decoding of DTS CD bitstreams. Playback of this format may produce undesirable noise.

Related information

[There is no sound or the sound is too low.](#) on page 50

Network Issues

If the TV network is connected, the screen will display that it is connected successfully.

Problems	Possible Solutions
The TV cannot connect to apps.	<ul style="list-style-type: none">• Make sure the TV has a network connection.• Contact your Internet service provider.
The wireless network connection fails.	<ul style="list-style-type: none">• Make sure your wireless modem/router is on and connected to the Internet.

Troubleshooting



Problems	Possible Solutions
The wireless network signal is too weak.	<ul style="list-style-type: none">Position your wireless router, modem router, or access point in a central location. Avoid putting it in a corner.

Related information

[My TV cannot connect to the network.](#) on page 52

Channel and Broadcast Issues

For problems while watching live TV or scanning for new services, these suggestions might help to resolve them.

Problems	Possible Solutions
In Live TV, there is no signal, or a weak signal, or you cannot find any channels.	<ul style="list-style-type: none">Make sure that the antenna cable is connected to the correct port.Make sure that the antenna cable is not loose or disconnected.If "no signal or weak signal" occasionally happens, disconnect antenna cable and reconnect it.Run Reset to Factory Default or scan channels again.<ul style="list-style-type: none"> > Settings > System > Restart > Settings > Channels & Inputs > Channels > Manual Scan



Related information

[Prepare Live TV](#) on page 5





[Channel Scan](#) on page 7

External Device Connection Issues

When the TV has difficulties with external device connection, these solutions may help resolve the problem.

Problems	Possible Solutions
The TV is having trouble receiving a signal in the cable box.	<ul style="list-style-type: none">If there is no signal occasionally, unplug cable from TV and re-plug after 60 seconds.If there is always no signal, or the signal cannot be restored after plugging and unplugging, you can press  /  button to select HDMI Format if you select HDMI as input, to confirm whether the signal can be recognized.Change to another HDMI port.Change to another HDMI cable.

Troubleshooting

Problems	Possible Solutions
There is no sound.	<ul style="list-style-type: none">• Check whether ARC/eARC is selected at  > Settings > Display & Sound > Audio Output > Audio Output Selection. If not, you need to check whether the external power amplifier device is connected to the ARC/eARC port or optical port of the TV.•  > Settings > Display & Sound > Audio Output > Digital Audio Out. You can try to select Auto, Pass Through, PCM, Dolby Audio - Dolby Digital, or Dolby Audio - Dolby Digital Plus.• Whether the power amplifier device port is connected correctly.• If you select HDMI as input, you can try  /  > HDMI Format.

Related information

[External source connected but no picture or sound](#). on page 52



HDMI & CEC Issues

When HDMI & CEC is not working, these steps may help resolve the problem.

Problems	Possible Solutions
HDMI & CEC does not work.	<ul style="list-style-type: none">• Confirm that the device is a HDMI & CEC compatible device.• Check if the power cable of the HDMI & CEC device is properly connected.• Check the cable connection of the HDMI & CEC device is secure.• Check HDMI & CEC feature of your TV is turned on.  > Settings > Channels & Inputs > Inputs > HDMI control• Check HDMI & CEC feature of the connected device is turned on.• Depending on the connected HDMI device, the HDMI & CEC control feature may not work.

Application Issues

When some apps do not play, this may help resolve the problem.

Problem	Possible Solutions
Netflix cannot be played.	<ul style="list-style-type: none">•  > Settings > Apps > See all apps > Netflix > Force stop, then reopen to try again.• You can try to restart the TV at  > Settings > System > Restart.

Media Files

When files do not play, this may help resolve the problem.

Troubleshooting

Problem	Possible Solutions
Some files cannot be played.	<ul style="list-style-type: none">• Most files can be played back, but you might experience problems with corrupted files or files with high-bitrate, unsupported resolution, unsupported container or codec formats.

Related information

[Media](#) on page 45

Voice Service Issues

When some Voice service will not function, this may help resolve the problem.

Problems	Possible Solutions
Alexa cannot be heard.	<ul style="list-style-type: none">• You can try to log into your Amazon account.• If you hear "I don't understand" from the voice recognition, please change account or log out of the account.• For more information about Alexa, please refer to Benefits of Smart TV >Using Voice Control > Alexa Setup in this manual.

Other Issues

Use these procedures to resolve other issues that may occur.

Problems	Possible Solutions
The TV is hot.	<ul style="list-style-type: none">• Watching TV for an extended period of time causes the panel to generate heat. The heat from the panel is dissipated through internal vents running along the top of the TV.• After extended use, you may feel heat when touching it. This heat is not a defect and does not affect the TV's functionality.
The TV smells of plastic.	<ul style="list-style-type: none">• This smell is normal and will dissipate over time.
The plastic cabinet makes a "clicking" type of sound.	<ul style="list-style-type: none">• The "clicking" sound can be caused when the temperature of the TV changes. This change causes the TV cabinet to expand or contract, which makes the sound. This is normal and the TV is OK.
When I turn on my TV, there is a delay for a few seconds before the picture appears. Is this normal?	<ul style="list-style-type: none">• Yes, this is normal. The TV is initializing and searching for the previous setting information.