

Hisense

**32N2170HW
39N2170PW
40N2170PW
43N2170PW
49N2170PW**

QUICK SETUP GUIDE

Before using the TV, please read this guide thoroughly and retain it for future reference. For more detailed instructions, please see the User Manual.

English

Declaration

Declaration

Any content and service accessed through this device, while only intended for individual non-commercial use, shall be the property of the applicable third party and subject to protection by regulations and laws on copyright, patent, trademark and other intellectual property rights. No part of such content and service may be modified, duplicated, published, uploaded, distributed, translated, marketed, or used to make and distribute products derived from it without the prior permission of the content owner or service provider.

You acknowledge and agree explicitly that you will solely bear the risk associated with the use of this device, and further you will solely bear any risk related to satisfactory quality, performance and accuracy for any content and service accessed through this device. To the maximum extent permitted by applicable law, this device and any third party's content and service is provided as it is without any guarantee, express or implied.

Manufacturer hereby declare explicitly that Manufacturer shall not be held liable for any guarantee and conditions, express or implied, related to this device and any content and service, including but not limited to warranty on marketability, satisfactory quality, fitness for a particular purpose, accuracy, quiet use and non-violation of any third party's rights; to the maximum extent permitted by applicable law, Manufacturer gives no guarantee on the accuracy, validity, timeliness, legitimacy and completeness of any content or service provided through this device, or the fitness of such device, content or service for your particular requirement, or the protection from interruption and error during operation of such device, content or service; to the maximum extent permitted by applicable law, in any case, including fault or neglect, Manufacturer shall not be held liable for legal actions or indemnity obligation arising from any consequence as a result of or related to any information loaded in this device or use of such device, content or service by you or any third party .

Any content and service provided as it is together with this device shall be the property of the applicable third party, therefore Manufacturer gives no declaration or warranty on modification, suspension, cancellation, termination or abortion thereof, and shall not be held liable for legal actions or indemnity obligation arising thereof.

Manufacturer reserves the rights to restrict the use or access of certain content or service. As the content and service are transmitted through third party's network and transmission facilities, Manufacturer undertakes no customer service thereof or the obligation for such customer service.

Important Safety Precautions



This symbol alerts user about the presence of a dangerous voltage not isolated inside the product which can be sufficiently powerful to constitute a risk of electrocution.



This symbol alerts user about the presence of important operating instructions and maintenance in the document enclosed in the package.



ATTENTION

RISK OF SHOCK
ELECTRIC



Do not open the back cover.

In no case the user is allowed to operate inside the TV set. Only a qualified technician is entitled to operate.

Disposal of Used Electrical & Electronic Equipment



Packaging and electrical goods should be recycled appropriately, and not treated as household waste. Please dispose of this equipment at your applicable collection point for the recycling of electrical & electronic equipment waste. By ensuring the correct disposal of this product, you will help prevent potentially hazardous to the environment and to human health, which could otherwise be caused by unsuitable waste handling of this product. The recycling of materials will help conserve natural resources. Please do not therefore dispose of your old electrical and electronic equipment with your household waste. For more detailed information about recycling of this product, please contact your local city office, your household waste disposal service or the shop where you purchased the product.

Warning

If a television is not positioned in a sufficiently stable location, it can be potentially hazardous due to falling. Many injuries, particularly to children, can be avoided by taking simple precautions such as:

- Using cabinets or stands recommended by the manufacturer of the television.
- Only using furniture that can safely support the television.
- Ensuring the television is not overhanging the edge of the supporting furniture.
- Not placing the television on tall furniture (for example, cupboards or bookcases) without anchoring both the furniture and the television to a suitable support.
- Not standing the televisions on cloth or other materials placed between the television and supporting furniture.
- Educating children about the dangers of climbing on furniture to reach the television or its controls.

Important Safety Precautions

Safeguards

Please read the following safeguards for your TV and retain for future reference. Always follow all warnings and instructions marked on the television.

1. A note about safety and operating instructions

Read and follow all safety and operating instructions, and retain them safely for future reference.

2. Heed Warnings

Adhere to all warnings on the appliance and in the operating instructions.

3. Cleaning

Unplug the TV from the wall outlet before cleaning. Do not use liquid, abrasive, or aerosol cleaners. Cleaners can permanently damage the cabinet and screen. Use a lightly dampened cloth for cleaning.

4. Wall Bracket

After market brackets may be available to purchase locally. Please refer to the specification page for dimensions.

5. Water and Moisture

Avoid dripping or splashing of liquids onto the product. Objects filled with liquids, such as vases, should not be placed on the product.

6. Setting

Do not place this TV on an unstable cart, stand or table. Placing the TV on an unstable base can cause the TV to fall, resulting in serious personal injuries as well as damage to the TV. Use only a cart, stand, bracket or table recommended by the manufacturer or salesperson.

7. Ventilation

Slots and openings in the cabinet are provided for ventilation, to ensure reliable operation of the TV and to protect it from overheating. Do not cover the ventilation openings in the cabinet and never place the set in a confined space such as built-in cabinet unless proper ventilation is provided. Leave a minimum 10cm gap all around the unit, the rear of the TV should be 6cm away from the wall.

Important Safety Precautions

8. Power Source

This TV should be operated only from the type of power source indicated on the marking label. If you are not sure of the type of power supplied to your home, consult your appliance dealer or local power company.

9. Power-Cord Protection

Power- supply cords should be routed so that they are not likely to be walked on or pinched by items placed upon or against them, paying particular attention to cords at plug, wall outlets, and the point where they exit from the TV. MAIN plug is used as the disconnect device, the disconnect device shall remain readily operable.

10. Lightning

For added protection for this TV during a lightning storm, or when it is left unattended and unused for long periods of time, unplug it from the wall outlet and disconnect the antenna or cable system. This will prevent damage to the TV due to lightning or power-line surge.

11. Power Lines

An outside antenna system should not be located in the vicinity of overhead power lines or other electric light or power circuits, or where it can fall into such power lines or circuits. Where installing an outside antenna system, extreme care should be taken to keep from touching such power lines or circuits as contact with them might be fatal.

12. Overloading

Do not overload wall outlets and extension cords as this can result in a risk of fire or electric shock.

13. Object and Liquid Entry

Never push objects of any kind into this TV through openings as they may touch dangerous voltage points or short-out parts that could result in fire or electric shock. Never spill liquid of any kind on or into the TV.

14. Outdoor Antenna Grounding

If an outside antenna or cable system is connected to the TV, be sure the antenna or cable system is grounded so as to provide some protection against voltage surges and built-up static charges.

15. Servicing

Do not attempt to service this TV yourself as opening or removing covers may expose you to dangerous voltage or other hazards. Refer all servicing to qualified service personnel.

Important Safety Precautions

16. Damage Requiring Service

Unplug the TV from the wall outlet and refer servicing to qualified service personnel under the following conditions:

- (a) When the power - supply cord or plug is damaged.
- (b) If liquid has been spilled, or objects have fallen into the TV.
- (c) If the TV has been exposed to rain or water.
- (d) If the TV does not operate normally by following the operating instructions. Adjust only those controls that are covered by the operating instructions as an improper adjustment of other controls may result in damage and will often require extensive work by a qualified technician to restore the TV to its normal operation.
- (e) If the TV has been dropped or the cabinet has been damaged.
- (f) When the TV exhibits a distinct change in performance - this indicates a need for service.

17. Replacement Parts

When replacement parts are required, be sure the service technician has used replacement parts specified by the manufacturer or have the same characteristics as the original part. Unauthorized substitutions may result in fire, electric shock or other hazards.

18. Safety Check

Upon completion of any service or repair to the TV, ask the service technician to perform safety checks to determine that the TV is in safe operating condition.

19. Heat

The product should be situated away from heat sources such as radiators, heat registers, stoves, or other products (including amplifiers) that produce heat.



Incorrect replacement of the battery may lead to the risk, including the replacement of another similar or the same type. Do not expose batteries to heat such as sun or fire or something like that.



The device should not be exposed to dripping and spraying and it cannot be placed under objects filled with liquids.



Main plug is used as the disconnect device, the disconnect device shall remain ready for operating.

Contents

Contents

Accessories List.....	1
Installing the Stand.....	2
TV Front.....	3
TV Rear.....	4
Making Connections.....	5
Remote Control.....	9
Turning the TV on for the First Time.....	11
Specifications.....	12

Accessories List

The following accessories are included with TV:



TV



Base Stand

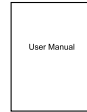

User Manual



Quick Setup Guide



Remote Control



AAA Battery × 2



Screw × 4

Installing the Stand

Installing the Stand

⚠ CAUTION

- Be sure to disconnect the A/C power cord before installing a stand or Wall-Mount brackets.
- The LED display is very fragile, and must be protected at all times when installing the base stand. Be sure that no hard or sharp object, or anything that could scratch or damage the LED display, comes into contact with it. DO NOT exert pressure on the front of the TV at any time because the screen could crack.

Follow the illustrations and instructions below to complete the installation steps:

1. Carefully place your TV facedown on a soft, flat surface to prevent damage to the TV or scratching to the screen.
2. Remove the 2 stands from the accessory bag and then insert the stands into the bottom slots of the TV.
3. Secure the BASE STAND to the TV with the 4 screws in accessory tightly.

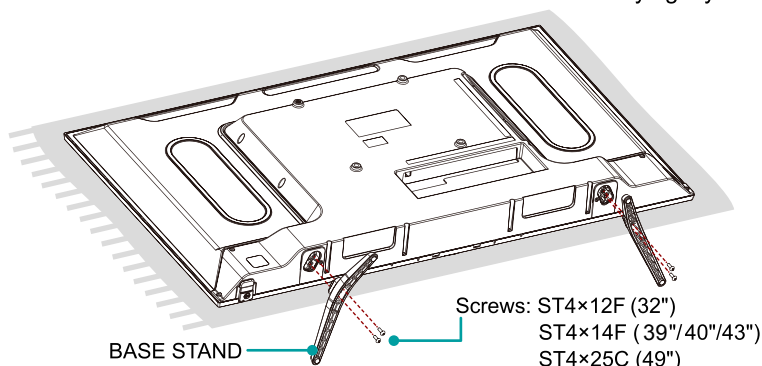

📌 NOTE

Pictures are only for reference, actual product may vary in appearance.

▶ WALL-MOUNT BRACKET SPECIFICATIONS

Wall-Mount hole pattern (mm)	200 × 200
Wall-Mount screw size	M6

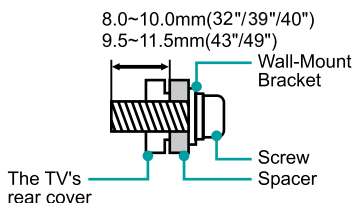

TV Front

TV Front

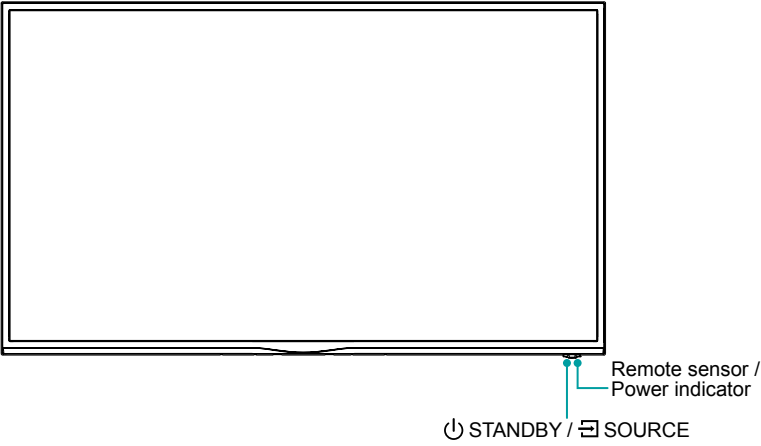

Item	Description
Remote sensor	Receive remote signals from the remote control. Do not put anything near the sensor, as its function may be affected.
Power indicator	Red light up in standby mode. Blue light up in power on mode.
⏻ STANDBY/ 📺 SOURCE	Press the button to turn on the TV. Press the button for a few seconds to put the TV in standby mode. Touch to select among the different signal sources.

📌 NOTES

- The Picture is Only for Reference.
- It takes several seconds to power on the TV and load program. Do not rapidly turn the TV on and off as it may cause the TV to work abnormally.

TV Rear

TV Rear

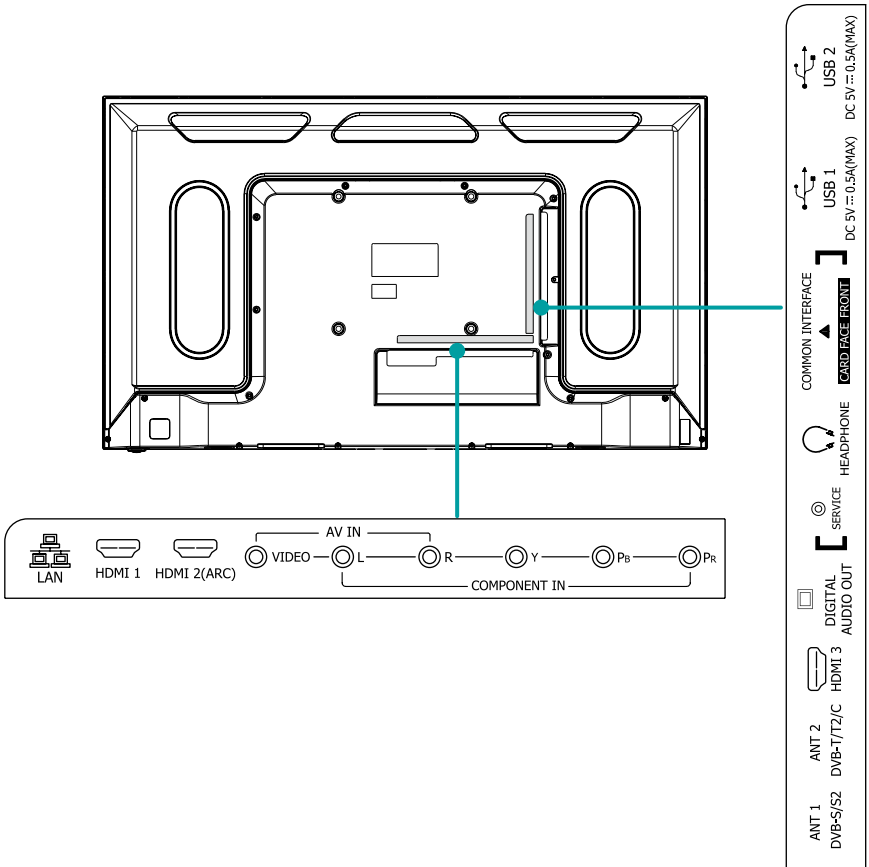

NOTES

- Check the jacks for position and type before making any connections. Loose connections can result in image or color problems. Make sure that all connections are tight and secure.
- The TV may not be compatible with all external devices. To check compatibility, please refer to the user manual of external device.
- Do not connect external equipment while TV's power cord is plugged in. It may cause electric shock.
- Service jack is not available for you to connect an external device. It can only be used by our factory for testing purposes.

Making Connections

▶ ANT 1 Connecting a satellite antenna.

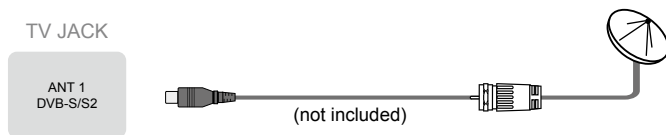

▶ ANT 2 Connect an outdoor VHF/UHF antenna or cable.

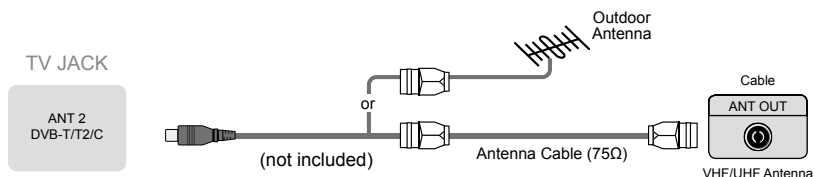

▶ COMMON INTERFACE

Insert the CI+ module for watching scrambled services like pay-tv channels or some HD channels.



☒ NOTES

- Before you insert/remove the CI+ module, ensure that the TV is switched off. Then insert the CI card into the CI+ module in accordance with the Service Provider's instructions.
- Do not repeatedly insert or remove the Common Access Module as this may damage the interface and cause a malfunction.
- You must obtain a CI+ module and card from the service provider of the channels you want to watch.
- Insert the CI+ module with the SmartCard in the direction marked on the module and SmartCard.
- CI+ is not supported in some countries and regions; check with your authorized dealer.

Making Connections

▶ HDMI / COMP / AV

Connect a HDMI / COMP / AV cable from an external A/V equipment. No sound connection is needed for HDMI to HDMI connection. If the signal resolution does not match the specification table, you need to change the setting of device according to the table. Please consult your device user manual for instruction.

- To select the HDMI / COMPONENT / AV.

Press **[INPUT]** button, when the list of input source appears, press **[< / >]** to select the source **HDMI / COMPONENT / AV**, then press **[OK]** to connect.

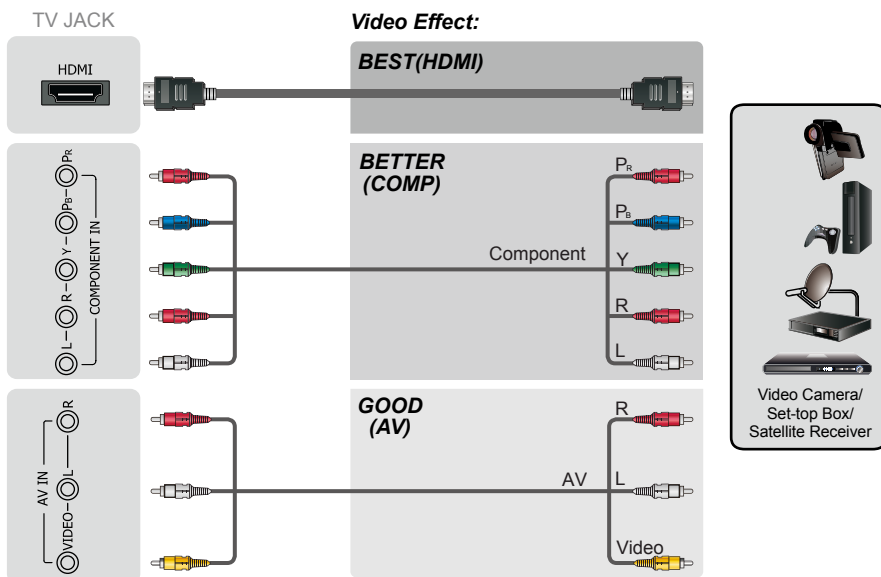

▶ HEADPHONE Connect Headphone for audio out of the TV.

The built-in speakers will be disabled once the headphone is connected.

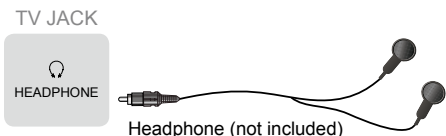

ATTENTION

Excessive sound pressure from earphones and headphones can cause hearing loss.

NOTE

Please make sure that the headphone you plug in is without microphone function, or it may not be supported.

Making Connections

- ▶ **ARC** Connect an HDMI cable from an external digital audio system.

ARC enables the TV to directly output the digital sound through an HDMI cable. Please note that it works only when the TV is connected to the audio receiver that supports the ARC (Audio Return Channel) function.

When this jack is used as the ARC function, it can't be used as signal input at the same time.

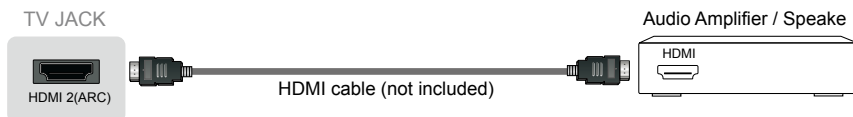

- ▶ **DIGITAL AUDIO OUT** Connect an digital audio cable from an external digital audio system.

Optical SPDIF is a type of digital audio interconnect cable used in consumer audio equipment to output audio over reasonably short distances. The signal is transmitted over a digital audio cable.

Before connecting a digital audio system to the DIGITAL AUDIO OUT jack, you should decrease the volume of both the TV and the system to avoid that may cause damage the speakers.

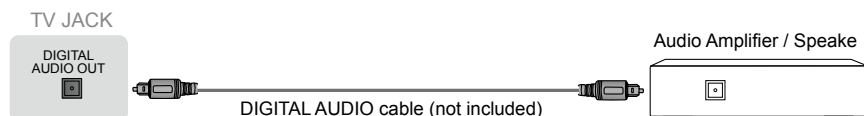

- ▶ **USB**

Connect the USB1.1, USB2.0 devices such as hard drives, USB sticks and digital cameras for browsing photos, listening music and watching recorded movies. You can record live TV program (refer to PVR in User Manual). When updating make sure the correct software is loaded on USB, Also updating instructions must be follow. At the same time update is also an easy thing and will be done just by plugging the USB with the updating files into the USB interface.

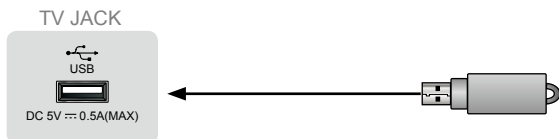

NOTES

- When connecting a hard disk or a USB hub, always connect the mains adapter of the connected device to the power supply.
- If a USB 1.1 or USB2.0 device requires more than 500mA or 5V, the USB device may not be supported. Exceeding the max supported current may result in damage or data loss.
- If you want to store the video streaming of a DTV program, the transfer rate of the USB storage device must not be less than 5MB/s.

Making Connections

▶ LAN (Wired setup)

Connect your TV to your network by connecting the LAN port on the back of your TV to an external modem or router using a LAN (Ethernet/Cat 5) cable. See the illustration below.

- We recommend to use a modem or router that supports Dynamic Host Configuration Protocol (DHCP). Modems and routers that support DHCP automatically provide the IP address, subnet mask, gateway, and DNS, so you don't have to enter them manually. Most home networks already have DHCP.

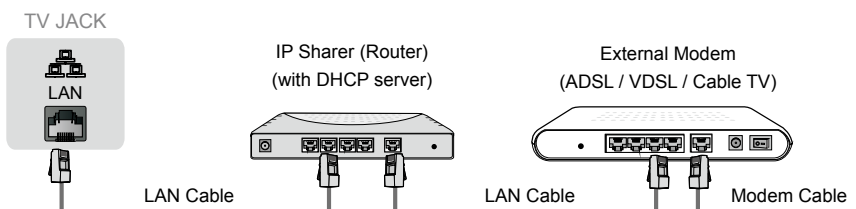

▶ Wireless setup

Connect your TV to your wireless network, you need a wireless router or modem. See the illustration below.

- The TV's built-in Wireless LAN Adapter supports the IEEE 802.11 b/g/n communication protocols.



☒ NOTES

- You must use the built-in Wireless LAN Adapter to use a wireless network because the set doesn't support external USB network adapter.
- If the wireless router supports DHCP, your TV can connect more easily to the wireless network.
- If you apply a security system other than the systems listed below, it will not work with the TV.
Security system: WPA, WEP, WPA2.
- In order to guarantee smooth network, the distance between router and TV is less than 10 meters.

Remote Control

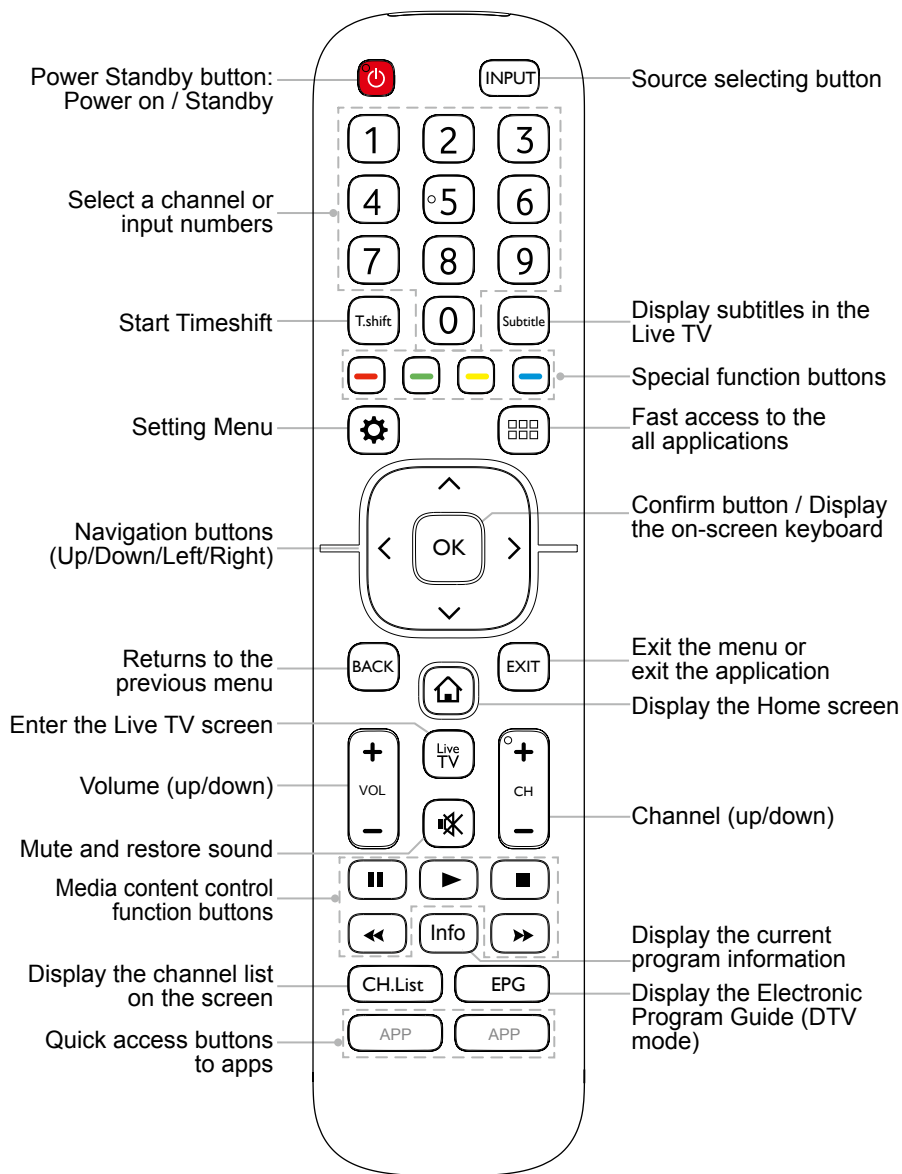

Remote Control

► Installing Batteries in the Remote Control

1. Slide the back cover to open the battery compartment of the remote control.
2. Insert two AAA size batteries. Make sure to match the (+) and (-) ends of the batteries with the (+) and (-) ends indicated in the battery compartment.
3. Close the battery compartment cover.

❶ Gently push and slide

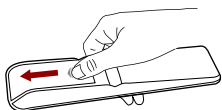

❷ Insert the batteries

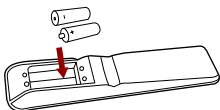

❸ Gently push and slide

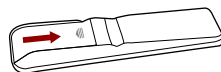

▣ NOTES

- Product image is only for reference, actual product may vary in appearance.
- Dispose of your batteries in a designated disposal area. Do not throw the batteries into a fire.
- Do not mix battery types or combine used batteries with new ones.
- Remove depleted batteries immediately to prevent battery acid from leaking into the battery compartment.
- If you do not intend to use the remote control for a long time, remove the batteries.
- Batteries should not be exposed to excessive heat, such as sunshine, heat Radiators, or fire.
- Battery chemicals can cause a rash. If the batteries leak, clean the battery compartment with a cloth. If chemicals touch your skin, wash immediately.

► Remote Control Operation Range

1. The remote control can work at a distance of up to 8 meters in front of the TV set.
2. The remote control angle: taking the remote sensor as an apex, 6 meters away, its controlled horizontal angle is within $\pm 30^\circ$, while the vertical angle is within $\pm 15^\circ$.
3. The operating distance may vary depending on the brightness of the room.

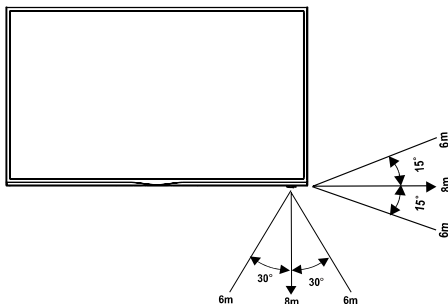

Turning the TV on for the First Time

Turning the TV on for the First Time

1. Connect the mains cable to the mains socket after you have completed all input connections.
2. The first time you turn the TV on, it will go straight into the Installation Guide. It will assist you to specify the Language, Country, Time Zone, Disclaimer, Network, Mode and Input.
3. Press the [^ / v / < / >] to navigate the menu and change the settings. Press the [OK] button to confirm.

Language	Select your desired language to be displayed on the menu.
Country	Select the country where you will operate the TV.
Time Zone	Select the local time zone according to your region.
Disclaimer	Accept the Disclaimer.
Network	If your TV does not automatically detect wired network, then select Wireless network. When you're done, select your network from the list that displays and move to the next screen.
Mode	Select Use Mode Setting: Home Mode or Store Mode. NOTE: 'Store mode' should only be selected by Retailers who plan to demonstrate the TV.
Input	Select how you receive your TV channels. Choose from one of the following sources below. <ul style="list-style-type: none"> • HDMI • DTV • Satellite • ATV • Component • AV

Specifications

Features, appearance and specifications are subject to change without notice.

If you encountered difficulty when setting up your TV, we suggest you refer to the troubleshooting tips in the User Manual.

Item		32"	39"	40"
Dimension (mm)	Without Stand (W × H × D)	734 × 434 × 93	886 × 517 × 84	912 × 538 × 81
	With Stand (W × H × D)	734 × 474 × 171	886 × 564 × 203	912 × 580 × 203
Weight (kg)	Without Stand	4.3	6.4	6.7
	With Stand	4.4	6.5	6.9
Active Screen Size (Diagonal)		32 inches	39 inches	40 inches
Screen resolution		1366 × 768	1920x1080	1920 × 1080
Audio power		6W + 6W	7W + 7W	7W + 7W
Power consumption		Please refer to the rating label.		
Power supply		100 - 240V~ 50/60Hz		
Receiving systems	Analog	PAL-D/K, B/G, I SECAM-D/K, B/G, L/L'		
	Digital	DVB-S/S2, DVB-T/T2, DVB-C		
Environmental conditions		Temperature: 5°C - 45°C Humidity: 20% - 80% RH Atmospheric pressure: 86 kPa - 106 kPa		
Component Input		480 I / 60 Hz, 480 P / 60 Hz, 576 I / 50 Hz, 576 P / 50 Hz, 720 P / 50 Hz, 720 P / 60 Hz, 1080 I / 50 Hz, 1080 I / 60 Hz, 1080 P / 50 Hz, 1080 P / 60 Hz		
HDMI Input		60 Hz (640×480, 800×600, 1024×768) 60 Hz (480 I, 480 P, 720 P, 1080 I, 1080 P) 50 Hz (576 I, 576 P, 720 P, 1080 I, 1080 P)		

Specifications

Item		43"	49"
Dimension (mm)	Without Stand (W × H × D)	971 × 567 × 92	1106 × 646 × 87
	With Stand (W × H × D)	971 × 613 × 203	1106 × 696 × 243
Weight (kg)	Without Stand	8.8	12.3
	With Stand	9.0	12.6
Active Screen Size (Diagonal)		42.6 inches	49 inches
Screen resolution		1920 × 1080	1920 × 1080
Audio power		7W + 7W	8W + 8W
Power consumption		Please refer to the rating label.	
Power supply		100 - 240V~ 50/60Hz	
Receiving systems	Analog	PAL-D/K, B/G, I SECAM-D/K, B/G, L/L'	
	Digital	DVB-S/S2, DVB-T/T2, DVB-C	
Environmental conditions		Temperature: 5°C - 45°C Humidity: 20% - 80% RH Atmospheric pressure: 86 kPa - 106 kPa	
Component Input		480 I / 60 Hz, 480 P / 60 Hz, 576 I / 50 Hz, 576 P / 50 Hz, 720 P / 50 Hz, 720 P / 60 Hz, 1080 I / 50 Hz, 1080 I / 60 Hz, 1080 P / 50 Hz, 1080 P / 60 Hz	
HDMI Input		60 Hz (640×480, 800×600, 1024×768) 60 Hz (480 I, 480 P, 720 P, 1080 I, 1080 P) 50 Hz (576 I, 576 P, 720 P, 1080 I, 1080 P)	