

Quick Start Guide

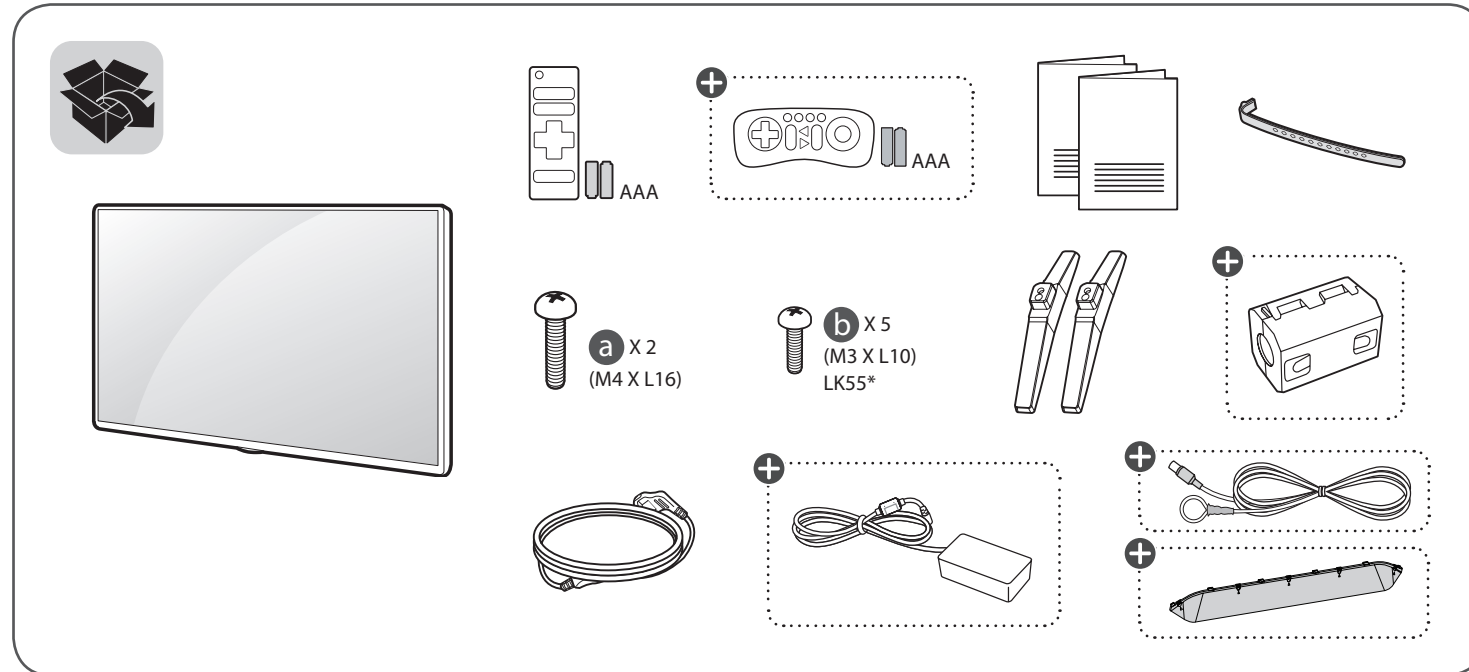

⊕ : Depending on model

Unpacking

Check your product box for the following items. If there are any missing accessories, contact the local dealer where you purchased your product. The illustrations in this manual may differ from the actual product and item.
*Image may vary depending on models

!

English

- Read **Safety and Reference**.
- For the power supply and power consumption, refer to the label attached to the product.





LK51*, LK52*, LK53*

1

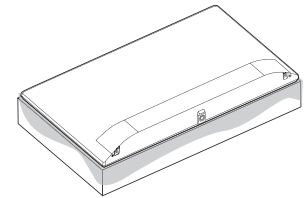

2-A 32LK51*, 32LK52*, 43LK53*

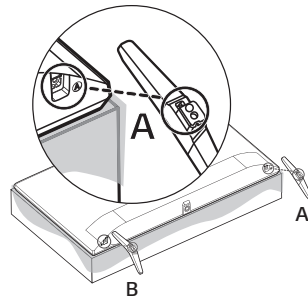

2-B 32LK53*

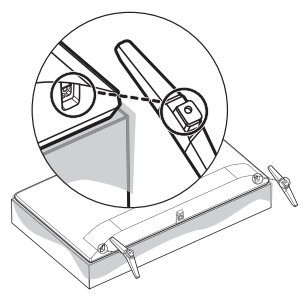

3

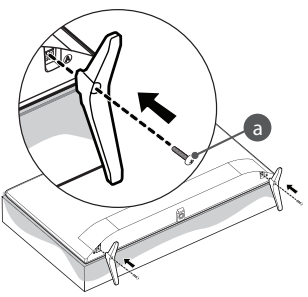

4

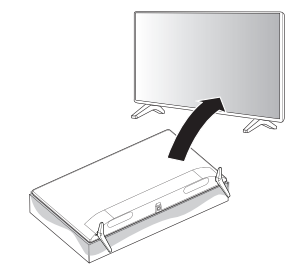

5-A 32LK51*, 32LK52*

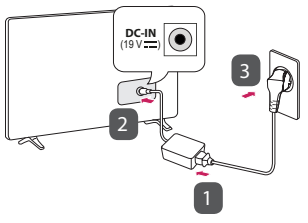

5-B 32/43LK53*

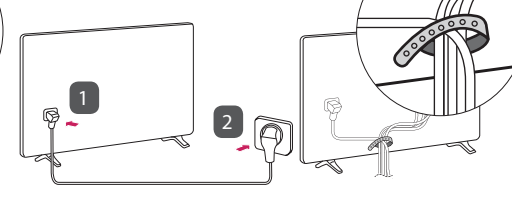

1

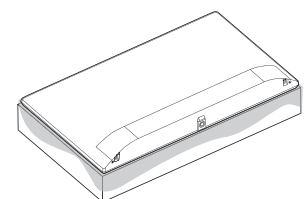

2

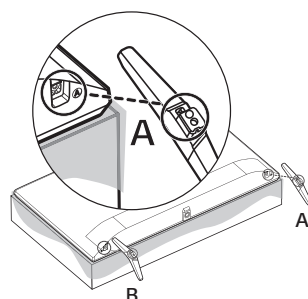

3

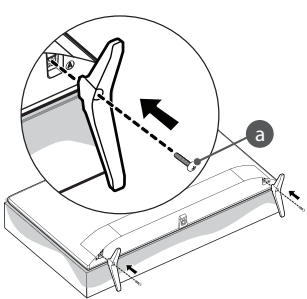

4

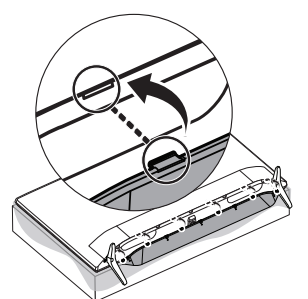

5

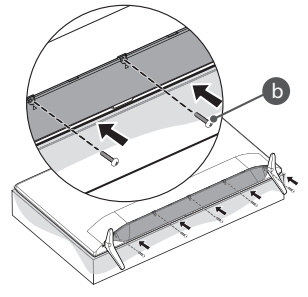

6

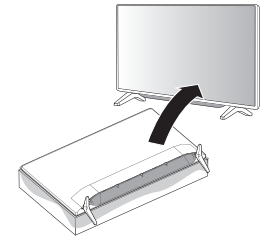

7

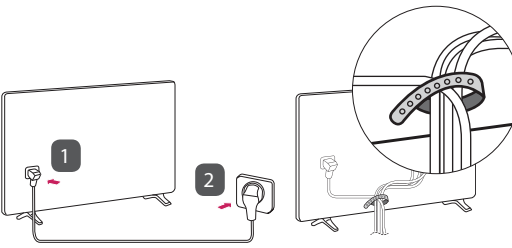

⊕ : Depending on model

CAUTION
Image shown may differ from your TV.
When attaching the stand to the TV set, place the screen facing down on a cushioned table or flat surface to protect the screen from scratches.

NOTE
Image shown may vary depending on model.



ANTENNA/
CABLE IN

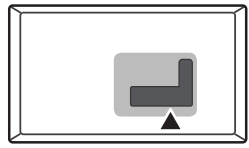
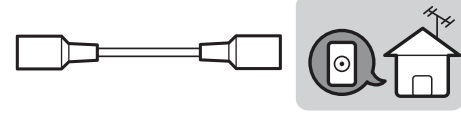

RADIO
ANTENNA IN

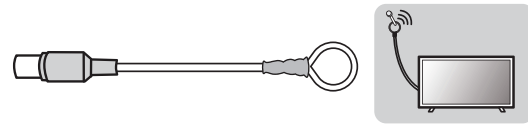

CAUTION
Image shown may vary depending on model.
All connection cables & devices shown in the picture are not included along with the TV set.

Satellite IN



HDMI IN



USB IN

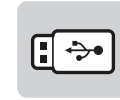

CAUTION
Image shown may vary depending on model.
All connection cables & devices shown in the picture are not included along with the TV set.

COMPONENT IN

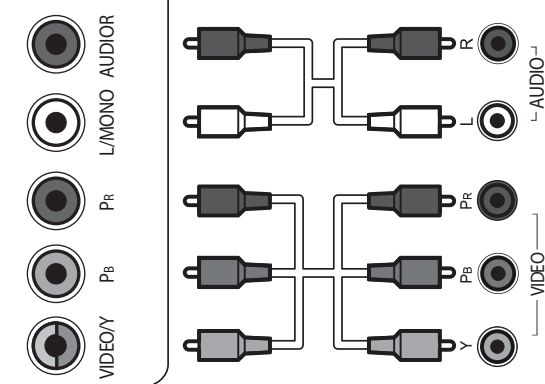

CAUTION
Image shown may vary depending on model.
All connection cables & devices shown in the picture are not included along with the TV set.

AV IN

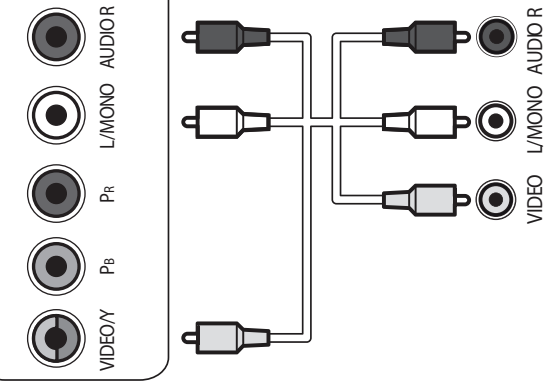

NOTE
• Some USB Hubs may not work. If a USB device connected using a USB Hub is not detected, connect it to the USB port on the TV directly.
• Connect the external power source if your USB is needed.

NOTE
• Do not look into to the optical output port, Looking at the laser beam may damage your vision.
• Audio with ACP (Audio Copy Protection) function may block digital audio output.

OPTICAL DIGITAL AUDIO OUT

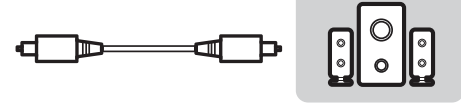

H/P OUT

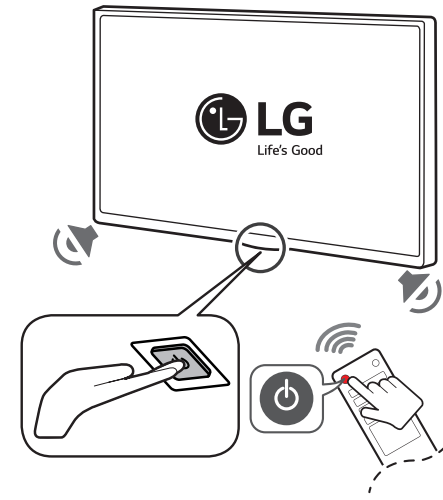

CAUTION
Image shown may vary depending on model.



+

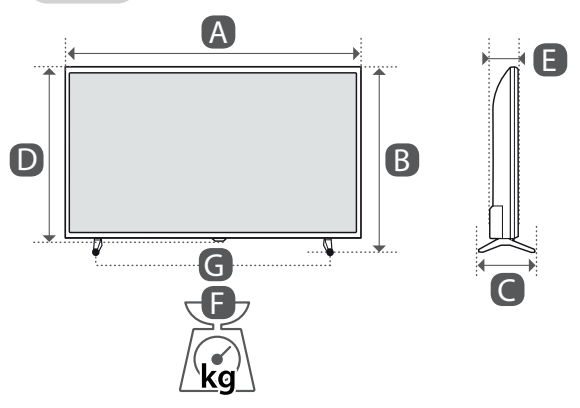
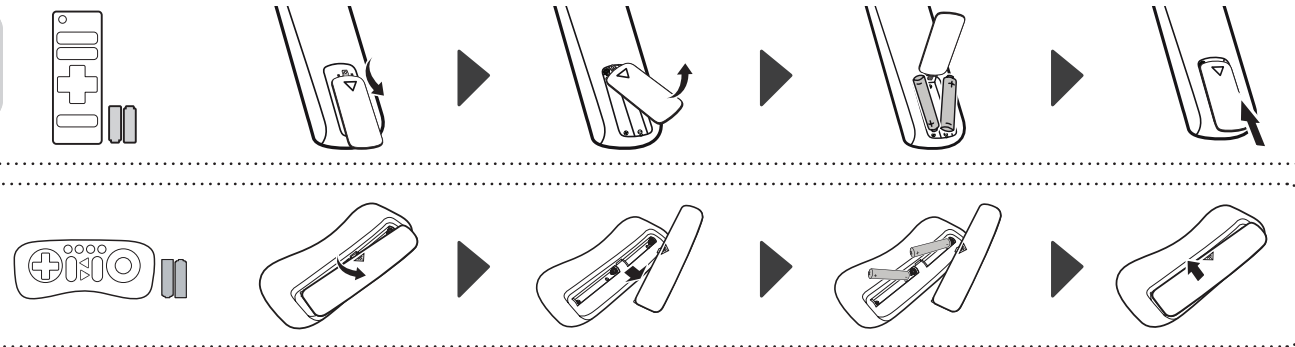

	A	B	C	D	E	F	F-G
	(mm)				(kg)		
32LK510BPTA 32LK510BPVD 32LK510BYVD	739	472	168	441	84	4.90	4.85
Power requirement	19 V --- 2.0 A						
32LK526BPTA	739	472	168	441	84	5.10	5.05
Power requirement	19 V --- 2.2 A						
32LK536BPTB	742	472	180	445	86.5	5.55	5.50
43LK5360PTA	975	612	188	571	85.2	8.2	8.1
Power requirement	AC 100-240 V ~ 50 / 60 Hz						

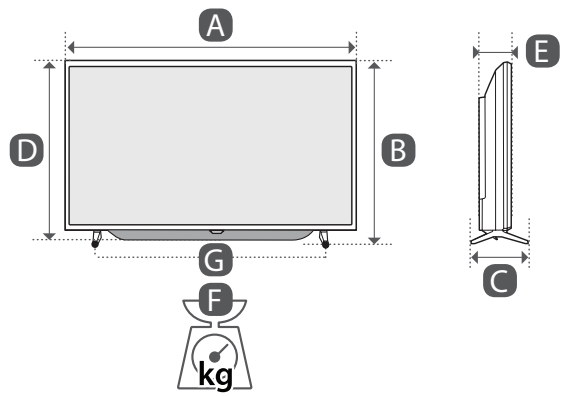

	A	B	C	D	E	F	F-G
	(mm)				(kg)		
32LK558BPTF	739	472	168	461	92.6	5.90	5.85
Power requirement	AC 100-240 V ~ 50 / 60 Hz						

CAUTION
Image shown may vary depending on model.