

# Haier

*LED LCD TV  
OWNER'S MANUAL*

*MODEL: LE32K6000  
LE40K6000*

# Haier

Please READ this manual carefully  
before operating your TV, and retain  
it for future reference

The Haier logo consists of a solid gray square with the word "Haier" written in white, sans-serif font inside it.

Haier

# Contents

1、 Safety and warnings.....	2-3
2、 Introduction.....	4
3、 Wall Mount Installation.....	5
4、 Installation.....	6-9
5、 Remote Controller.....	10
6、 TV Operation.....	11-14
7、 Trouble shooting.....	15

**IMPORTANT SAFETY INSTRUCTION**

- 1) Read these instructions.
- 2) Keep these instructions.
- 3) Heed all warnings.
- 4) Follow all instructions.
- 5) Do not use this apparatus near water.
- 6) Clean only with dry cloth.
- 7) Do not block any ventilation openings, install in accordance with the instructions.
- 8) Do not install near any heat sources such as radiations, heat registers, stoves, or other apparatus (including amplifiers) that produce heat.
- 9) Do not defeat the safety purpose of the polarized plug. If the provided plug does not fit into your outlet, consult an electrician for replacement of the obsolete outlet.
- 10) Protected the power cord from being walked on or pinched particularly at plugs, convenience receptacles, and the point where they exit from the apparatus.
- 11) Only use attachments/accessories specified by the manufacturer.
- 12) Unplug this apparatus during lightning storms or when unused for long periods of time.
- 13) Refer all servicing to qualified service personnel. Servicing is required when the apparatus has been damaged in any way, such as power-supply cord or plug is damaged, liquid has been spilled or objects have fallen into the apparatus, the apparatus has been exposed to rain or moisture, does not operate normally, or has been dropped.
- 14) Mains plug is used as the disconnect device, the disconnect device shall remain readily operable.
- 15) The ventilation should not be impeded by covering the ventilation openings with items, such as newspapers, table-cloth, curtains, etc.
- 16) No naked flame sources, such as lighted candles, should be placed on the apparatus.
- 17) Attention should be drawn to the environmental aspects of battery disposal.
- 18) The use of apparatus in moderate climate.
- 19) The apparatus shall not be exposed to dripping or splashing and that no objects filled with liquids, such as vases, shall be placed on the apparatus.

<div style="display: inline-block; border: 1px solid black; padding: 2px; text-align: center; font-size: 8px;"> <b>CAUTION</b>              RISK OF ELECTRIC SHOCK              DO NOT OPEN!         </div>
<p><b>CAUTION</b></p> <p>TO REDUCE THE RISK OF ELECTRIC SHOCK, DO NOT REMOVE COVER (OR BACK). NO USER SERVICEABLE PARTS INSIDE. REFER SERVICING TO QUALIFIED SERVICE PERSONNEL.</p>

The symbol indicates that dangerous voltages constituting a risk of electric shock are present within this unit.

The symbol indicates that there are important operating and maintenance instructions in the literature accompanying this unit.

**WARNING:**

To reduce the risk of fire or electric shock, do not expose this apparatus to rain or moisture.

**WARNING:**

The batteries shall not be exposed to excessive heat such as sunshine, fire or the like.



This symbol indicates that this product incorporates double insulation between hazardous mains voltage and user accessible parts. When servicing use only identical replacement parts.



This marking indicates that this product should not be disposed with other household wastes throughout the EU. To prevent possible harm to the environment or human health from uncontrolled waste disposal, recycle it responsibly to promote the sustainable reuse of material resources. To return your used device, please use the return and collection systems or contact the retailer where the product was purchased. They can take this product for environmental safe recycling.

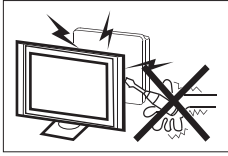

High voltages are used in the operation of this television receiver. Do not remove the cabinet back from your set. Refer servicing to qualified service personnel.

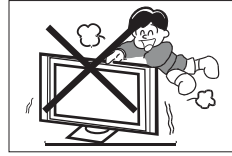

Never stand on, lean on, or suddenly push the television or its stand. You should pay special attention to children. Serious injury may result if it falls.

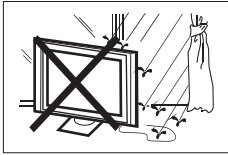

To prevent fire or electrical shock hazard, do not expose the television receiver to rain or moisture.

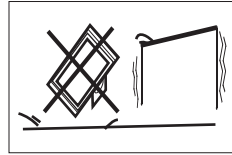

Do not place your television on an unstable cart, stand, shelf or table. Serious injury to an individual, and damage to the television, may result if it falls.



Do not drop or push objects into the television cabinet slots or openings. Never spill any kind of liquid on the television receiver.

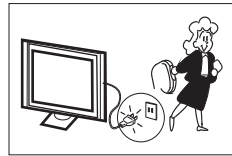

When the television receiver is not used for an extended period of time, it is advisable to disconnect the AC power cord from the AC outlet.



Do not block the ventilation holes in the back cover. Adequate ventilation is essential to prevent failure of electrical components.

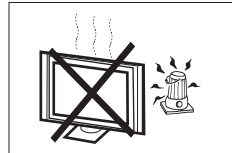

Avoid exposing the television receiver to direct sunlight and other sources of heat. Do not stand the television receiver directly on other products which give off heat, e.g. video cassette players and audio amplifiers. Do not place naked flame sources, such as lighted candles on the television.

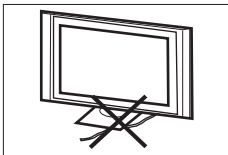

Do not trap the power supply cord under the television receiver.

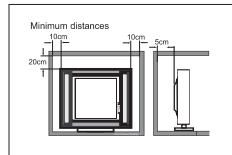

If the television is to be built into a compartment or similar enclosure, the minimum distances must be maintained. Heat build-up can reduce the service life of your television, and can also be dangerous.

## Main features

- ① Used as Television, display terminal, PC display;
- ② High luminance, wide viewing angle;
- ③ Can store 99 TV programs;
- ④ HDMI interface;
- ⑤ Multi-Media player (USB);

## Accessories

Infrared Remote Controller.....	1
Battery(AAA).....	2
User's Manual.....	1

## Main parameter

Model	32 inch	40 inch
Resolution	1366x768	1920x1080
Aspect Ratio	16 : 9	
TV System	PAL/NTSC/SECAM	
Video Signal System	PAL/NTSC/SECAM	
Receiving Channel	1-99	
Input Power Voltage	AC 100-240V 50/60Hz	
Power consumption	40W	68W
Audio Output Power (THD≤7%)	2 x 8W	
Signal Input/Output	Analog RGB(VGA) x 1 High-Definition Multimedia Interface(HDMI) x 3 Composite Video Input x 1 Audio Input x 1 Headphone x 1 YCb (Pb)Cr (Pr) x 1 USB x 1 COAXIAL x 1 RF x 1	
Horizontal definition (TV line)	Composite Video input >=350 Y Cb(Pb) Cr(Pr) >=400	



The terms HDMI and HDMI High-Definition Multimedia Interface, and the HDMI Logo are trademarks or registered trademarks of HDMI Licensing Administrator, Inc. in the United States and other countries.

**Step One:** Use the expansion bolts (4\*36PWA) to fix the wall mount brackets into the wall.

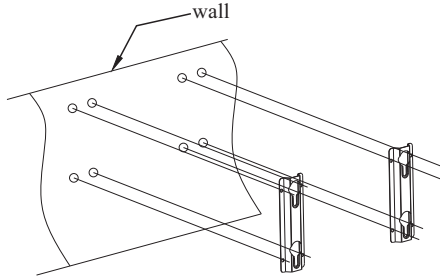

**Step Two:** Fix the wall mount screws (32":M4x5mm, 40":M6x8mm/4pcs) into the rear side of the LCD TV, using the tongue of 8kgf.cm.

\* The TV appearance subject to material object.

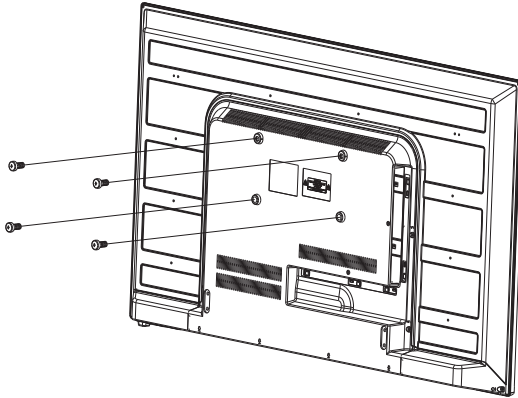

**Step Three:** Put the LCD TV with wall mount screws onto the wall mount brackets.

**Warning:** the angle between the TV and wall must not be bigger than 3°.

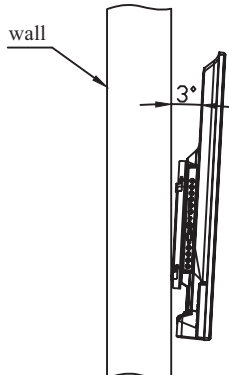

**Front panel**

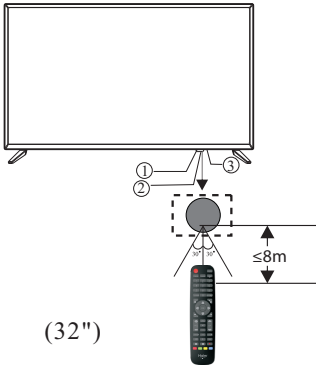

(32")

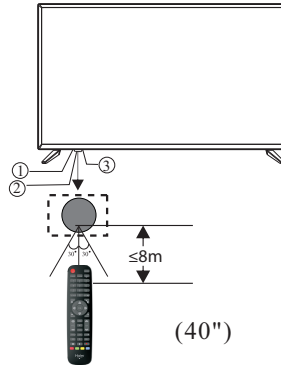

(40")

- 1: Remote control sensor.
- 2: Indicator LED: **RED** ● STANDBY.
- 3: Key board

- 1: Remote control sensor.
- 2: Indicator LED: **RED** ● STANDBY.
- 3: Key board

**KEYBOARD**

The keyboard is located at the bottom left near the right side of signal indicator.

Rocker

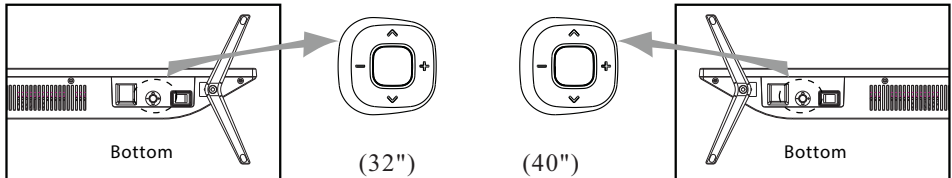

- 1. Middle Button: press longtime for “power” function; press once for “source” function
- 2. Up/Down: CH+/-
- 3. Left/Right: VOL-/+

**REAR AV Connections**



All the terminals are (from left to right):  
 HEADPHONE, AV INPUT, YPbPr INPUT, HDMI3, HDMI2, HDMI1.  
 Note: VIDEO and YPbPr share one audio channel.

**REAR AV Connections (SIDE)**



All the terminals are (from left to right):  
 VGA, RF, USB, COAXIAL.  
 Note: When HDMI port get DVI signal, the audio signal receives from the AV Audio channel.

ANTENNA

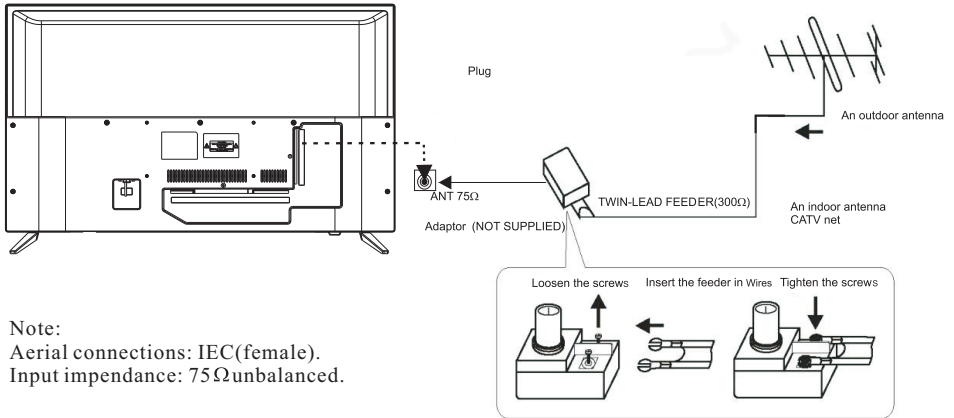

Note:  
 Aerial connections: IEC(female).  
 Input impedance: 75Ωunbalanced.

PC

STEPS:

Be sure both the TV and computer are Power off.

- 1.Connect VGA and audio cable
- 2.Connect power cord
- 3.Power on the TV, switch to PC mode
- 4.Power on the PC

This sequence is very important.

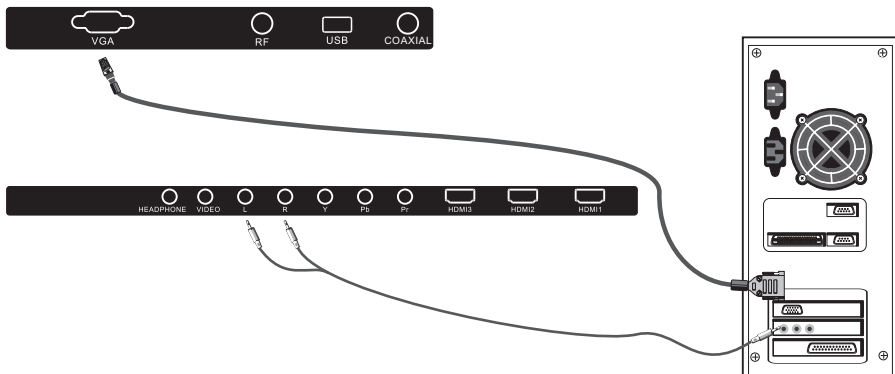

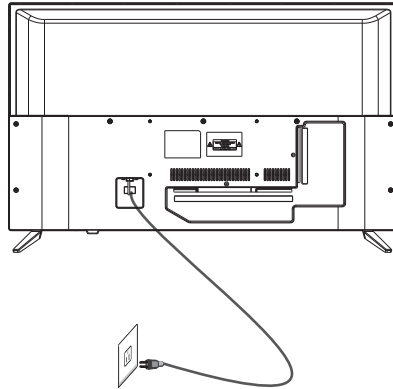

**PRESET MODE (PC)**

	RESOLUTION	V.Freq.(Hz)	H.Freq.(KHz)
1	800*600	60	37.88
2	1024*768	60	48.36
3	1360*768	60	47.7
4	1920*1080 (only for 40")	60	67.5

NOTE: PC V.Freq.(Hz) not more than 60Hz.

**PRESET MODE (HDMI)**

	RESOLUTION	V.Freq.(Hz)	H.Freq.(KHz)
1	800*600	60	37.88
2	1024*768	60	48.36
3	1360*768	60	47.7
4	1280*768	60	47.3
5	1920*1080	60	67.5

AV EQUIPMENT

This TV provides one group of AV, one group of YPbPr for convenient connection to VCR, DVD or other video equipment. Please refer to the owner's manual of the equipment to be connected as well. You can use the input terminals on TV set rear as follows.

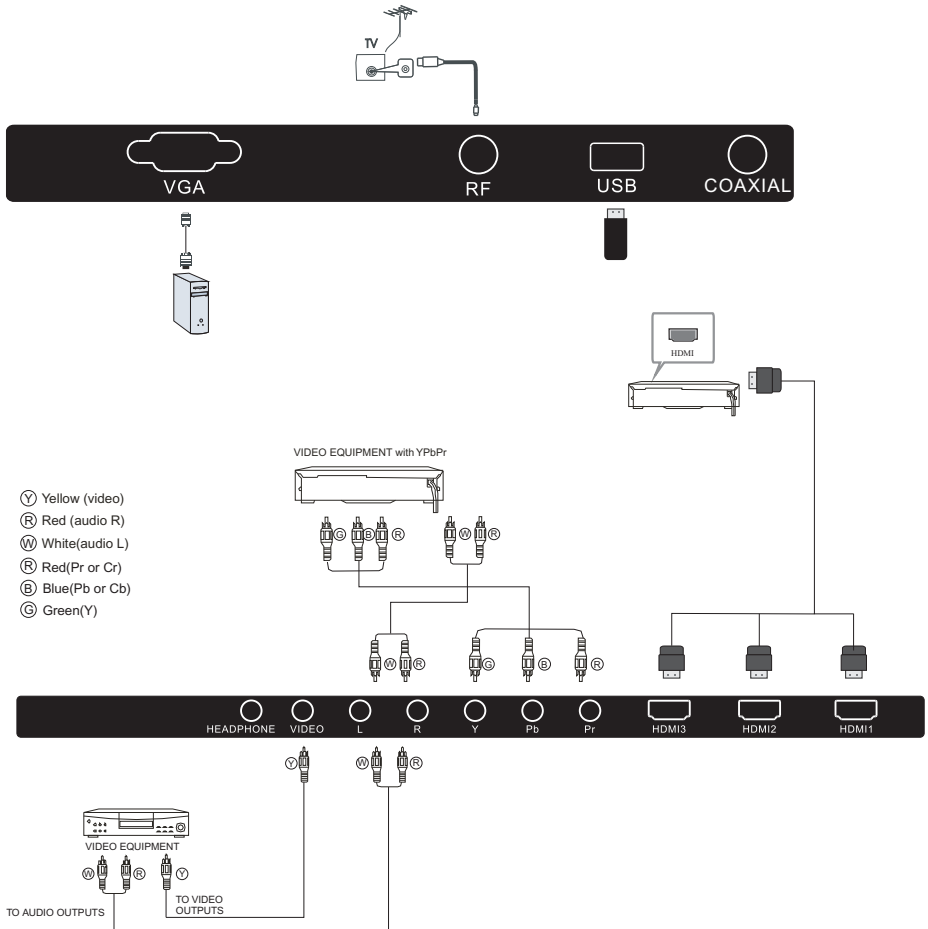

It can be connected to the following appliances: VCR, multi disc player, DVD, camcorder, video game or stereo system, etc... YPbPr can support these video formats: 480i, 576i, 480p, 576p, 720p, 1080i, 1080p.

- Note:
1. Video and YPbPr share one audio channel.
  2. When HDMI port get DVI signal, the "AV Audio" channel is changed to receive the audio for HDMI port.
  3. Sometimes it will not support in different device because the device supply nonstandard signal.

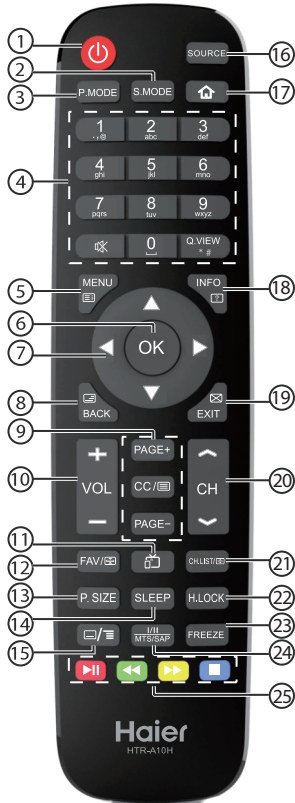

	PAGE+	Press to go to the next page in teletext mode.
9	CC/☐	Press to open the teletext.
	PAGE -	Press to go to the previous page in teletext mode.
	VOL +/-	Press to adjust the volume level.
10	☐	No function.
11	FAV/☐	Press to open a favorite channel list. In teletext mode, press to hold a page.
12	P.SIZE	Press to change the screen display mode.
13	SLEEP	Press to set the sleep timer.
14	☐/☐	In teletext mode, press the enter a secondary page. Press to open the APP menu of the MHL device.
15	SOURCE	Press to open the input source list.
16	☐	Press to open the home menu of the MHL device.
17	INFO/☐	Press to display the channel information. In teletext mode, press to reveal the hidden information.
18	EXIT/☐	Press to close the on-screen menu. In teletext mode, press to hide the text.
19	CH ☐/☐	Press to change the channel.
20	CH.LIST/☐	Press to open the channel list. In teletext mode, press to switch the image to top, bottom or full.
21	H.LOCK	Press to open the Hotel mode menu.
22	FREEZE	Press to freeze the picture.
23	I/II/MTS/SAP	Press to select the audio mode (depending on broadcast signal).
24	▶▶ (play/pause)	Press to play/pause in multimedia mode.
25	◀◀ (reverse)	Press to reverse playback in multimedia.
	▶▶ (forward)	Press to fast forward in multimedia mode.
	■ (stop)	Press to stop multimedia playback.

#	Button	Descriptions
1	⏻ (Power)	Press to turn the TV on or off.
2	S.MODE	Press to select the sound mode.
3	P.MODE	Press to select the picture mode.
4	0-9	Press to enter a channel number or password.
	Q.VIEW	Press to switch to the last viewed channel.
	🔇 (Mute)	Press to turn the sound on or off.
5	MENU/☐	Press to open the on-screen menu. In teletext mode, press to open the INDEX page.
6	OK	Press to confirm a selection.
7	⬆️⬇️⬇️⬆️	Press to navigate the on-screen menu.
8	BACK/☐	Press to return to the previous screen. In teletext mode, press to enter mix mode.

**Note:** The relevant button doesn't work if TV without teletext, NICAM, MHL function.

### Insert Batteries into the Remote Control

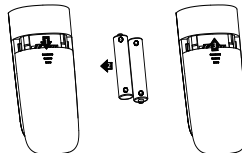

1. Remove the battery cover.
2. Inserting the 2 AAA 1.5V batteries making sure the polarity (+ or -) of the batteries matches the polarity marks inside the unit.
3. Mount the battery cover. Replace with new batteries when the TV set begins to show the following symptoms: Operation is unsteady or erratic. Sometimes the TV set does not function with Remote Control Unit.

#### Remark:

- 1) Alkaline Battery Recommended.
- 2) Remove batteries when they are exhausted or if the remote control is not to be used for long time.

### 1. CHANNEL MENU

The first item of the MENU is CHANNEL MENU ( for TV source only).

You can search channels and edit programs here. Press  $\blacktriangledown \blacktriangle$  to move, press OK button to confirm, and press  $\blacktriangleleft \blacktriangleright$  to adjust.



#### 1).Auto Scan:

Search all the TV channels automatically.

#### 2).TV Manual Tuning:

You can search the TV channels and fine tune the channels, then storage the channels you selected.

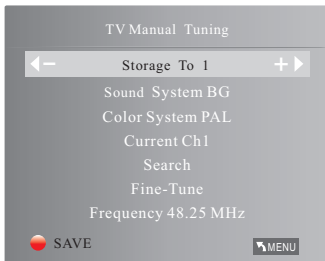

#### NOTE:

Press red button to storage to channels after manual tuning .

#### 3). Program Edit:

You can Delete, Rename or Skip any programs.

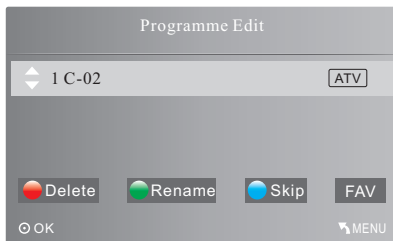

#### Delete

Press  $\blacktriangledown \blacktriangle$  to choose the program. Press red button, the program will delete.



#### Rename

Move the cursor to the program, press green button to rename the program.

Press  $\blacktriangledown \blacktriangle$  to choose the character. Press  $\blacktriangleleft \blacktriangleright$  to move the cursor.

Press MENU button to exit edit, Press EXIT to exit the menu.

Note: The TV programs name only can be 5 characters.





#### Skip

Press  $\blacktriangledown \blacktriangle$  to choose the program, press blue button to skip this program. The icon  will show on the right side of the program.

Choose the skipped program, press the blue button again, you can cancel the skip, Then the icon  will disappear.

#### FAV

Press  $\blacktriangledown \blacktriangle$  to choose the program, press FAV button, it will show  on the right side of the program. Choose the FAV program, press FAV button again, you can cancel the FAV, the  will disappear .

Once your favorite group is created, you can press the FAV key to quickly access your favorite channel.

### 2. PICTURE MENU

The second item of the MENU is PICTURE MENU. You can adjust picture effect here, such as contrast, brightness, etc.

Press  $\blacktriangledown \blacktriangle$  to move, press OK button to confirm, and press  $\blacktriangleleft \blacktriangleright$  to adjust.



#### NOTE:

1).Tint is available in NTSC system only.

2).There are four color temperature modes can be selected, such as normal, warm, cool, and user.

### 3. AUDIO MENU

The third item of the MENU is the AUDIO MENU.

You can adjust the sound effect here such as bass, treble, balance etc.

Press  $\blacktriangledown \blacktriangle$  to move, press OK button to confirm, and press  $\blacktriangleleft \blacktriangleright$  to adjust.



**Note:**

Auto volume: only available when the input signal volume is too large or distortion.

**4. TIME MENU**

The fourth item of the menu is the TIME MENU. You can adjust the clock, power on/off time, sleep timer etc.

Press ▼▲ to move, press OK button to confirm, and press ◀▶ to adjust.



**NOTE:**

Within 15 minutes there is no signal, the TV will auto sleep.

Once you power off the TV set by AC, the clock time will be reset.

**5. SETUP MENU**

The fifth item of the MENU is the SETUP MENU. You can adjust the MENU Language, Shop Mode, CEC, Blue Screen, Restore Factory Default or Software Update(USB).



**NOTE:**

Restore factory default will clear all the programs and reset all the settings to default value.

**6. USB FUNCTION**

You must enter the Source menu first, then choose the USB and press OK button, the USB menu will appear.

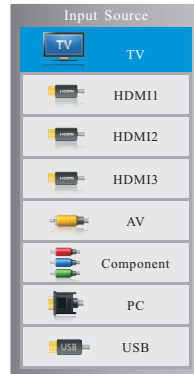

Please make sure that the USB device has been plugged in the slot. There are four type media item can be selected, such as photo, music, movie. Select the type media item by pressing ◀▶, press OK button to enter the disk selection menu.

In the movie mode, when you use FB, FF function, The audio may be pause in several seconds to synchronize the audio signal and video signal.

**NOTE:**

When the USB device isn't supported, it may be that the power of the USB device isn't enough.

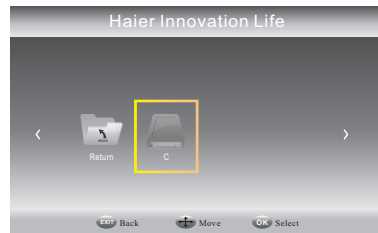

Press the ▶◀ to select the right disk and press OK to display media files and folder list or choose Return to back to the media type selection menu.

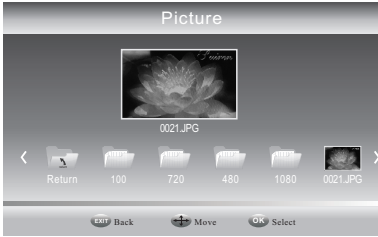

Select the media file by pressing ◀▶ or ▼▲, then the preview frame will pop up. Press the button ▶|| to play the media file in full screen. When the media file (photo, music, movie type) is playing, press the **OK** or **INFO** button can display the control bar.

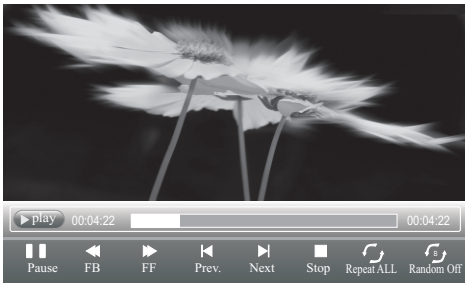

**NOTE:**  
Music function need to put music and picture in the same folder.



Press ◀▶ to select the function icon, press OK button to confirm the function.

Press ▼ or EXIT button to exit the control bar.

**NOTE:**

You can adjust the audio track, subtitle, or program in the Info menu while playing the video file.

Choose the Info icon and press OK can display the Info MENU.

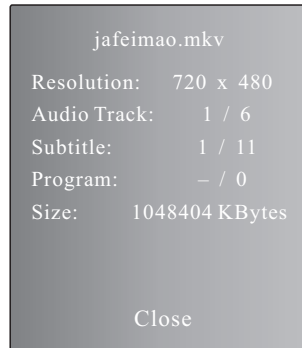

**Hotel Mode:**

Please press source key first, and then press number key “1001” to enter into Hotel Mode or press H.LOCK key to enter into Hotel Mode.

Hotel Mode Operation	
Hotel Mode	Off
Panel Key Lock	Off
Max Volume	100
Start Source	TV
Start Channel	1
Setup Menu Display	Yes
Source Key Lock	No
Volume Default	30

**Hotel Mode :** Set Hotel mode on/off.

**Panel Key Lock :** Keypad will be locked, when Key Lock mode is on.

**Max Volume:** Set max volume limited.This option allows you to set the Max Volume Level.













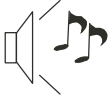

**Start Source :** Choose source, the options as follow: TV/Component/PC/HDMI1/HDMI2/HDMI3/AV/USB, press the ◀ or ▶ button to select the desired source.

**Start Channel :** In TV mode, you can select a channel number to be set as the TV present channel. Press the ◀ or ▶ button to select the desired channel number .

**Setup Menu Display :**Main menu lock , main menu will not display when set to “No”

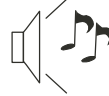
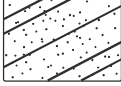
**Source Key Lock :** Source lock, you can't change the source, when set to “Yes”

**Volume Default :** Power on default volume, press the ◀ or ▶ button to select the desired volume.

Trouble phenomenon		Inspection
Picture	Audio	
 <p>Snow</p>	 <p>Noise</p>	antenna position, direction or connection
 <p>Ghost</p>	 <p>Normal audio</p>	antenna position, direction or connection
 <p>Interfere</p>	 <p>Noise</p>	electronic equipment, car/ motorcycle, fluorescent light
 <p>Normal Picture</p>	 <p>Mute</p>	Volume(inspect wether the mute function on the remote control are started , or audio system are correct or not)
 <p>No picture</p>	 <p>Mute</p>	Power cord is not inserted Power switch is not opened Contrast and brightness/volume setup Press standby key on the remote control for inspecting
 <p>No color</p>	 <p>Normal audio</p>	color control
 <p>Scramble</p>	 <p>Normal audio or weak</p>	retune channel
 <p>No color</p>	 <p>Noise</p>	Audio system

Special Explanation: The accessories such as remote control is not belongs to the guarantee.



# Haier

40330406095

