

Illustration in this guide are provided for reference only and may differ from actual product appearance. Product design and specification may be changed without notice.

LED Television

TABLE OF CONTENTS

IMPORTANT SAFETY INSTRUCTIONS	1
PRECAUTIONS AND REMINDERS	2
PREPARATION	3
PERIPHERAL CONNECTION AND CONTROLS	4
MAKING CONNECTIONS	5
OPERATING INSTRUCTIONS	6
TROUBLESHOOTING	17
PRODUCT SPECIFICATION	18



Illustration in this guide are provided for reference only and may differ from actual product appearance. Product design and specification may be changed without notice.

IMPORTANT SAFETY INSTRUCTIONS

- 1) Read these instructions.
- 2) Keep these instructions.
- 3) Heed all warnings.
- 4) Follow all instructions.
- 5) Do not use this apparatus near water.
- 6) Clean only with dry cloth.
- 7) Do not block any ventilation openings, install in accordance with the instructions.
- 8) Do not install near any heat sources such as radiations, heat registers, stoves, or other apparatus (including amplifiers) that produce heat.
- 9) Do not defeat the safety purpose of the polarized plug. If the provided plug does not fit into your outlet, consult an electrician for replacement of the obsolete outlet.
- 10) Protected the power cord from being walked on or pinched particularly at plugs, convenience receptacles, and the point where they exit from the apparatus.
- 11) Only use attachments/accessories specified by the manufacturer.
- 12) Unplug this apparatus during lightning storms or when unused for long periods of time.
- 13) Refer all servicing to qualified service personnel. Servicing is required when the apparatus has been damaged in any way, such as power-supply cord or plug is damaged, liquid has been spilled or objects have fallen into the apparatus, the apparatus has been exposed to rain or moisture, does not operate normally, or has been dropped.
- 14) Mains plug is used as the disconnect device, the disconnect device shall remain readily operable.
- 15) The ventilation should not be impeded by covering the ventilation openings with items, such as newspapers, table-cloth, curtains, etc.
- 16) No naked flame sources, such as lighted candles, should be placed on the apparatus.
- 17) Attention should be drawn to the environmental aspects of battery disposal.
- 18) The use of apparatus in moderate climate.
- 19) The apparatus shall not be exposed to dripping or splashing and that no objects filled with liquids, such as vases, shall be placed on the apparatus.
- 20) warning: To avoid any injury caused by lean of the product, please always ensure the whole product was placed within the table surface in horizontal.

Actual product may vary in appearance from above image

The main plug is used as the disconnect device, the disconnect device shall remain readily operable. the socket-outlet shall be easily accessible.

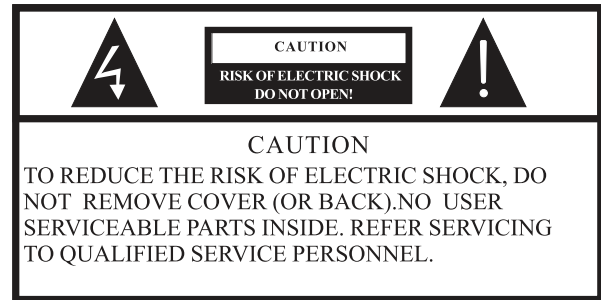

 The symbol indicates that dangerous voltages constituting a risk of electric shock are present within this unit.

 The symbol indicates that there are important operating and maintenance instructions in the literature accompanying this unit.

WARNING:
To reduce the risk of fire or electric shock, do not expose this apparatus to rain or moisture.

WARNING:
The batteries shall not be exposed to excessive heat such as sunshine, fire or the like.



This symbol indicates that this product incorporates double insulation between hazardous mains voltage and user accessible parts. When servicing use only identical replacement parts.



This marking indicates that this product should not be disposed with other household wastes. To prevent possible harm to the environment or human health from uncontrolled waste disposal, recycle it responsibly to promote the sustainable reuse of material resources. To return your used device, please use the return and collection systems or contact the retailer where the product was purchased. They can take this product for environmental safe recycling.

PRECAUTIONS AND REMINDERS

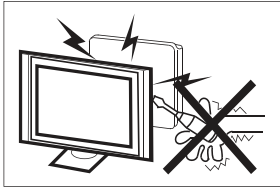

High voltages are used in the operation of this television receiver. Do not remove the cabinet back from your set. Refer servicing to qualified service personnel.

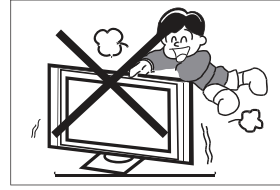

Never stand on, lean on, or suddenly push the television or its stand. You should pay special attention to children. Serious injury may result if it falls.

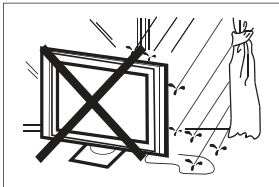

To prevent fire or electrical shock hazard, do not expose the television receiver to rain or moisture.

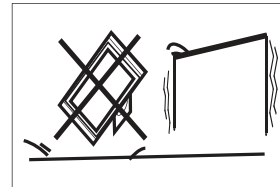

Do not place your television on an unstable cart, stand, shelf or table. Serious injury to an individual, and damage to the television, may result if it falls.

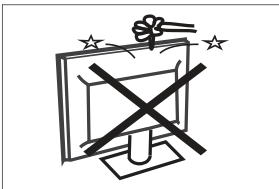

Do not drop or push objects into the television cabinet slots or openings. Never spill any kind of liquid on the television receiver.

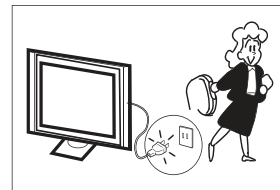

When the television receiver is not used for an extended period of time, it is advisable to disconnect the AC power cord from the AC outlet.

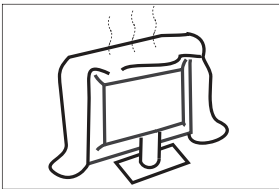

Do not block the ventilation holes in the back cover. Adequate ventilation is essential to prevent failure of electrical components.

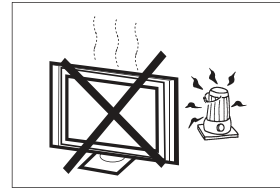

Avoid exposing the television receiver to direct sunlight and other sources of heat. Do not stand the television receiver directly on other products which give off heat, e.g. video cassette players and audio amplifiers. Do not place naked flame sources, such as lighted candles on the television.

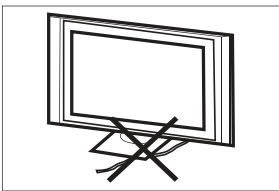

Do not trap the power supply cord under the television receiver.

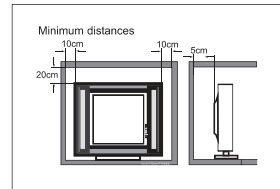

If the television is to be built into a compartment or similar enclosure, the minimum distances must be maintained. Heat build-up can reduce the service life of your television, and can also be dangerous.



If you are going to clean the product, Unplug the TV, use soft fabric, no water, never chemicals.

Note: the use of apparatus in moderate climates.

Note: This product uses a panel consisting of sub pixels which require sophisticated technology to produce. However, there may be a few bright or dark pixels on the screen. These pixels will have no impact on the performance of the product.

PREPARATION

IMPORTANT: Do not apply pressure to the screen display area which may compromise the integrity of the display. The manufacturer's warranty does not cover user abuse or improper installations.

ATTACHING THE STAND

IMPORTANT: The stand of the TV must be assembled prior to usage.

1. Place TV unit face down on a soft and flat surface (blanket, foam, cloth, etc.) to prevent any damage to the TV.
2. Fix the stand to the bottom of the TV with the 12 screws.

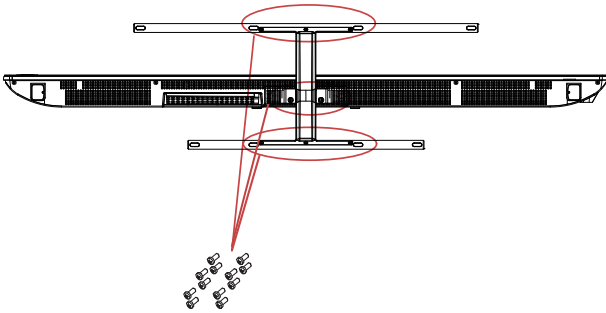

NOTE
The appearance of the product shall be in kind.

PREPARING YOUR LED TV FOR WALL MOUNTING

We suggest that you keep your TV at least 2.36 inches (60 mm) from the wall to prevent cable interference. Before mounting your TV on the wall, you need to remove the stand.

For your safety, please use only with a UL listed wall mount bracket with minimum weight of the TV without stand.

To attach a wall mount bracket to your TV:

1. Remove the screws holding your TV to the stand.
2. Remove the stand from your TV.
3. Secure the wall mount bracket to the back of your TV using four screws. Follow the instructions of the user manual that came with the wall mount bracket to install.

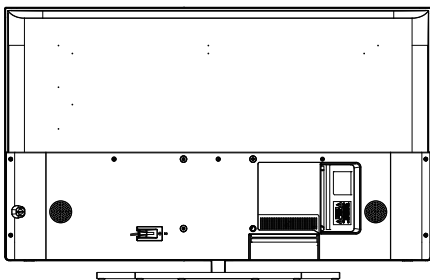

NOTE
The wall mount bracket are not included.

TURNING ON THE TV

1. Install the stand and place the TV on a solid surface.

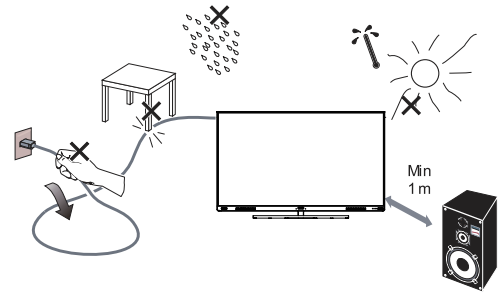

NOTE

- Ensure that the TV is placed in a position to allow free flow of air. Do not cover the ventilation openings on the back cover.
 - To prevent any unsafe situations, no naked flame sources, such as lighted candles, should be placed on or in the vicinity.
 - Avoid heat, direct sunlight and exposure to rain or water. The equipment shall not be exposed to dripping or splashing.
2. Connect the antenna cable or TV cable to the **ANT IN** aerial socket on the back of the TV set.
 3. Power:
Plug the cord into a working power outlet.

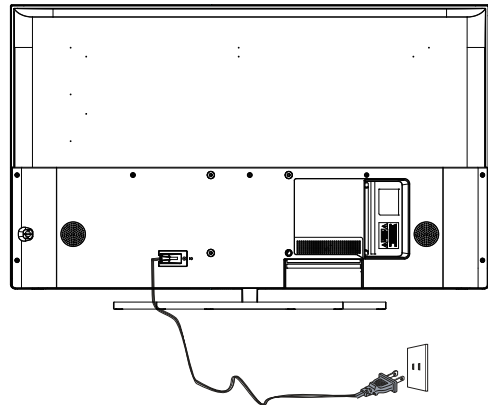

4. Turn the TV on:
Press  on the remote control or **POWER** button on the side control panel of the TV.

PERIPHERAL CONNECTION AND CONTROLS

BUTTON CONTROL

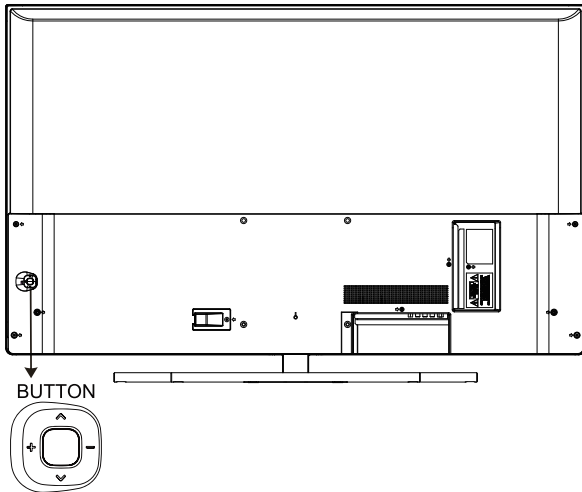

Middle key

In the standby mode, press the middle button to turn on the TV.
In the boot state, long press the middle button to shut down.
Under the menu page, function equivalent to the OK key.

Left and right keys

In the non-menu page, press the left and right keys to adjust the volume addition and subtraction.

Up and down keys

In the non-menu page, you can adjust the TV channel under the program addition and subtraction;
Under the menu page, you can move the cursor up and down.

ACCESSORIES

- TV 55"/65"
- Remote Control - 1pcs
- User's Manual - 1pcs
- Screws - 12 pcs
- Warranty Card -1pcs

PERIPHERAL CONNECTION



All the terminals are(from left to right):
RJ45, OPTICAL, HDMI4 4K@120Hz, HDMI3(eARC/ARC) 4K@120Hz, VIDEO, L, R, HDMI2 4K@60Hz



All the terminals are(from left to right):
HDMI1 4K@60Hz , LNB IN(SATELLITE), ANT IN(ANTENNA/CABLE), USB1 , USB2
CI,EARPHONE.

MAKING CONNECTIONS

You can use the input terminals on TV set rear as follows.

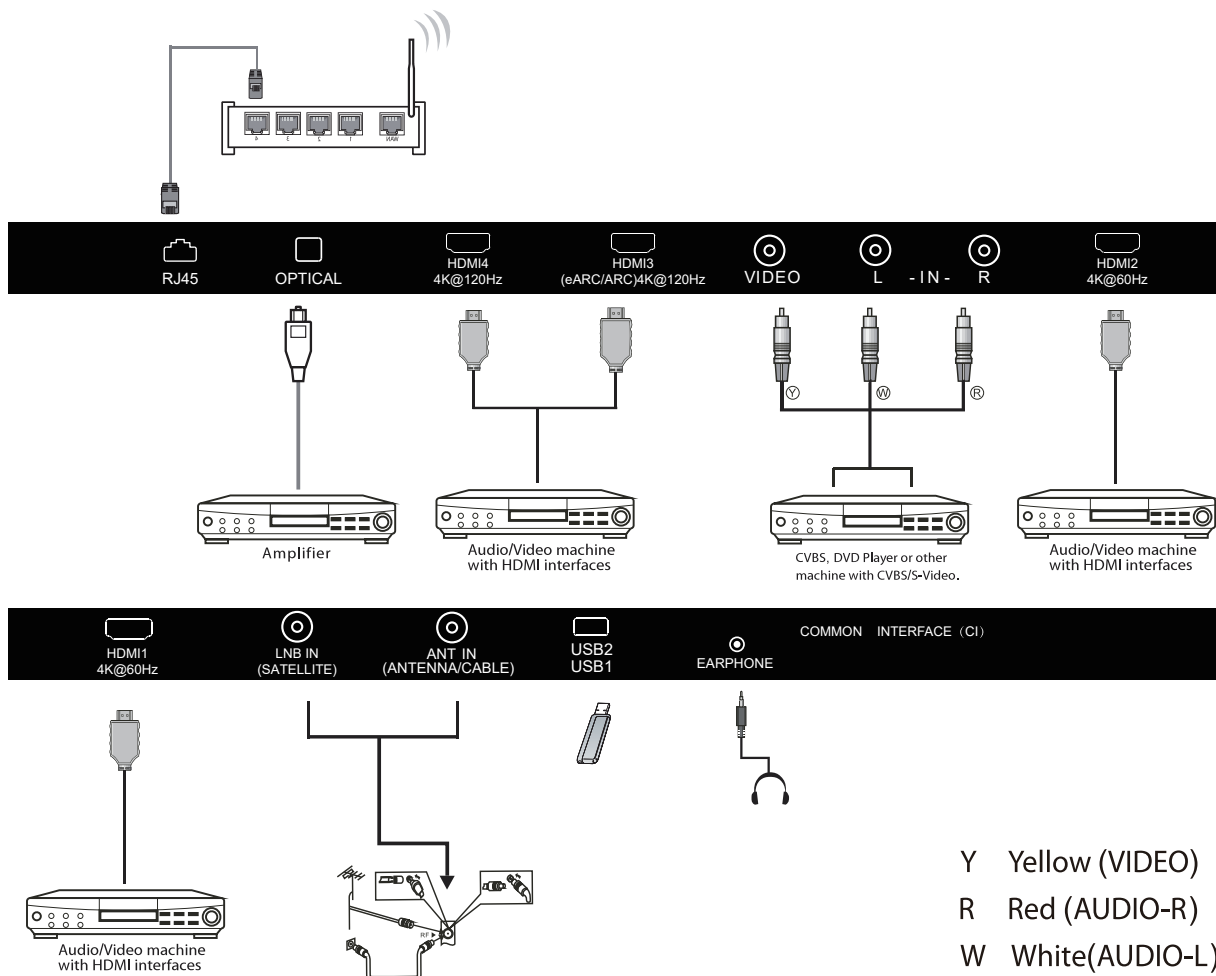

1. RF: Antennal/close circuit TV
2. EARPHONE: Earphone output.
3. USB: Connect USB device.
4. HDMI: Connect to High-definition multimedia signal resource.
5. AV INPUT: Video input/Audio input.

OPERATING INSTRUCTIONS

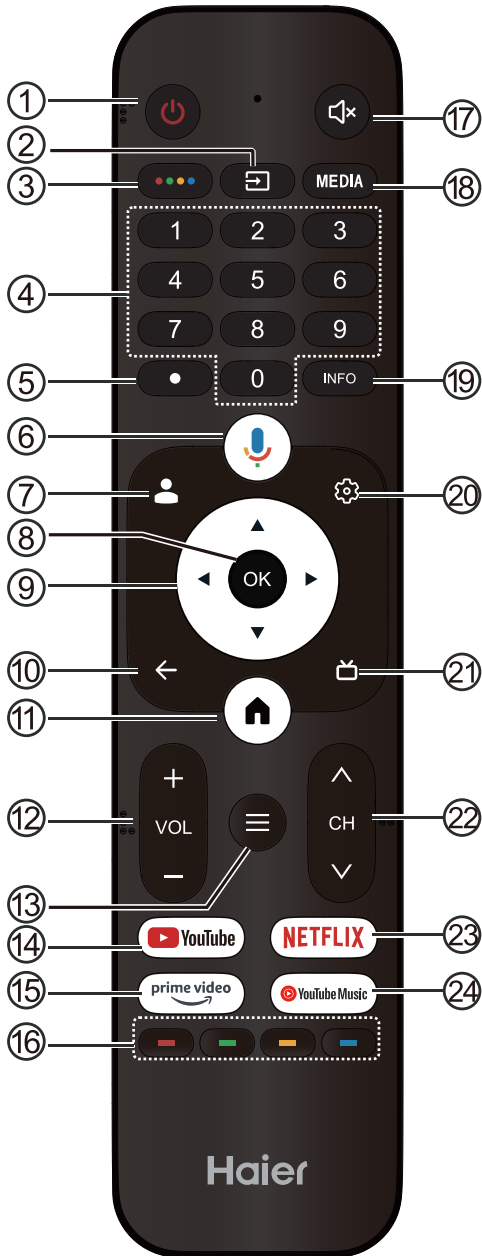

#	Item	Descriptions
1	Power	Press to turn the TV on or off. When your TV is off, power still flows through it. To completely disconnect power, unplug the power cord.
2		Press to open the input source list.
3		Press to open Soft Keyboard.
4	0~9 number	Press to enter a TV channel number.
5		Input the character "dot".
6		Press to enter start a voice search.
7		Switch Google accounts in Google TV mode.
8	OK	Enter the selected option or perform the selected operation.
9		Press to navigate the on-screen menu.
10	BACK	Return to the previous menu.
11		Press to open the Home Page.
12	VOL+/VOL-	Press VOL+ or VOL- to adjust volume level.
13	MENU	Press to open or close the on-screen menu.
14	YouTube	Press to open the YouTube.
15		Press to prime vido for viewing online TV shows and flms(internet connection required).
16	Coloured buttons	Implement the relevent operations according to the prompt at the botton of the menu in the text.
17		Press to open the mute.
18	MEDIA	Press to open Media.
19	INFO	Press to display the channel information.
20		Press to open the Dashboard.
21		Press to display electronic programme guide in TV mode.
22	CH^/CHv	Press CH^ or CHv to change TV channels.
23	NETFLIX	Press to open the NETFLIX.
24	YouTube Music	Press to open the YouTube Music.

Remove the cover of the battery compartment. Insert the 2 supplied batteries (Type AAA 1.5V).

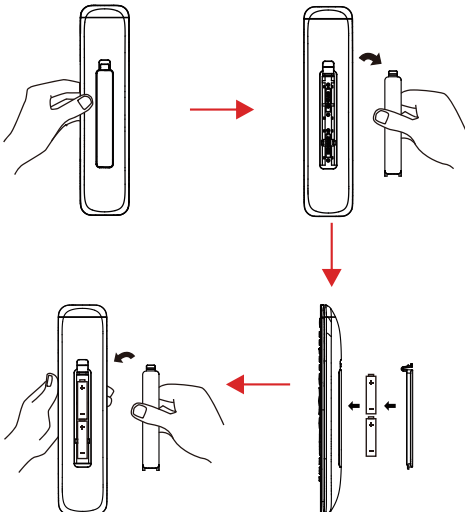

OPERATING INSTRUCTIONS

INITIAL SETUP

The first time you turn on your TV, the setup wizard will guide you through setting up basic settings. Please according to the Text Tip to First Time Setup.

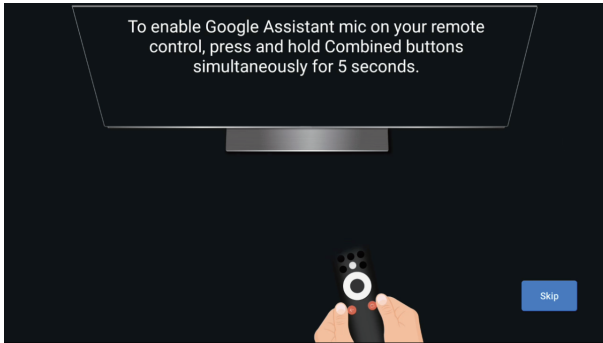

This function is used for the remote control pair code. After the code is successful, you can use the Bluetooth remote control to operate the TV.

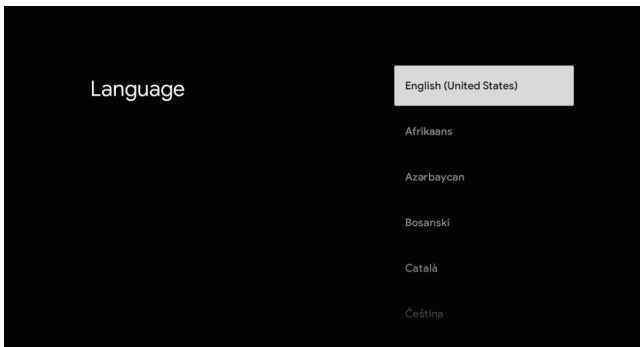

Press ▲/▼ to select the system language and press OK to confirm the language.

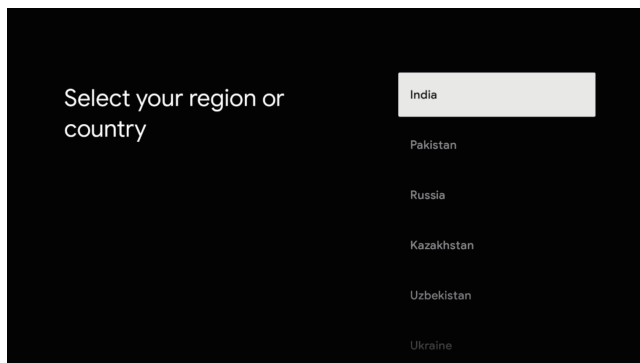

Press ▲/▼ to select the region/country of your device and press OK to confirm.

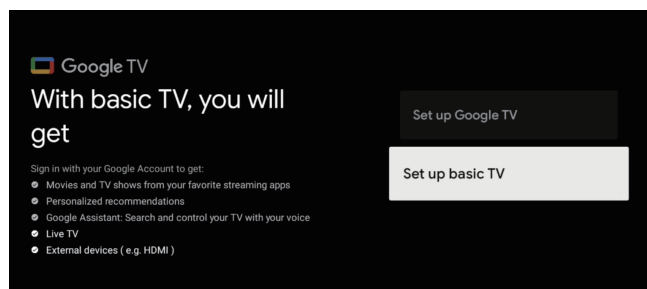

Press ▲/▼ to select the "Set up basic TV" of your device and press OK to complete the setup.

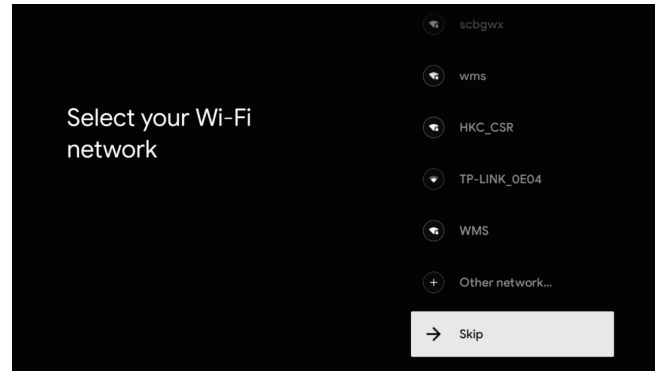

Press ▲/▼ to select the wifi to connect, press OK and enter the password to confirm the Connection is successful.

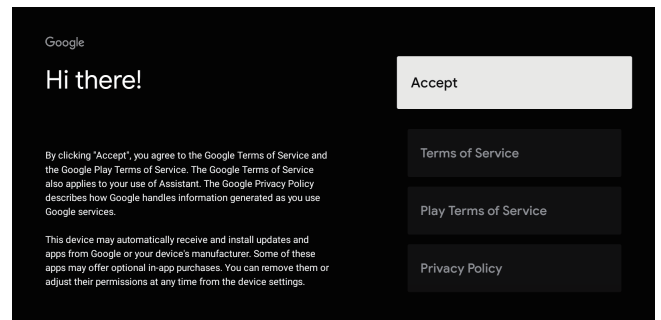

By accepting the Google Terms of Service to improve the product experience, select "Accept" to accept this condition.



Used to set your device's password to ensure security and privacy.

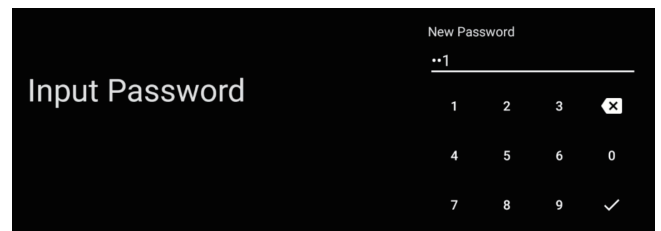

Press OK to pop up the soft keyboard, and use the remote control to enter the 4-digit password automatically jump to the next interface.

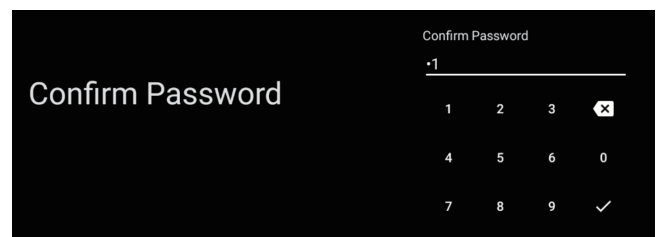

Confirm the password again and keep it consistent Use the remote control to enter the password and complete the password.

OPERATING INSTRUCTIONS

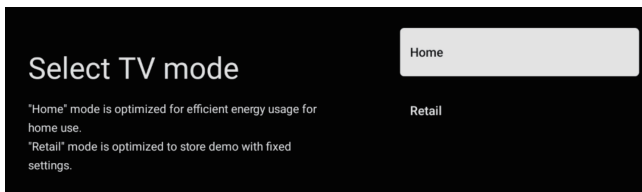

For selecting the mode, press ▲/▼ key to select Home mode and press "Yes".

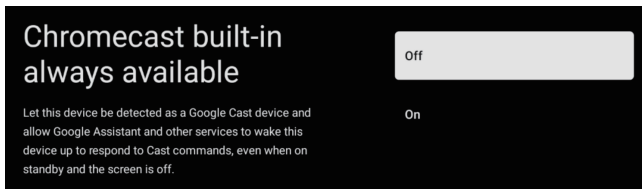

Select "On" to respond to cast commands, select "Off" to exit.

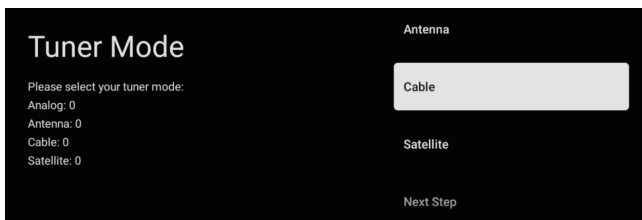

To select the Tuner mode for searching, press to select and press OK to confirm.

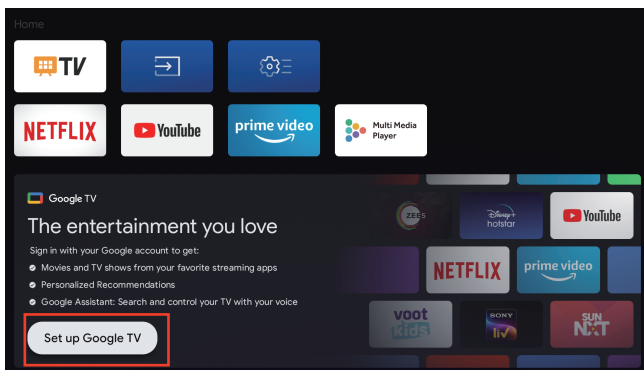

• Once in the user interface, you can switch from basic TV to Google TV settings

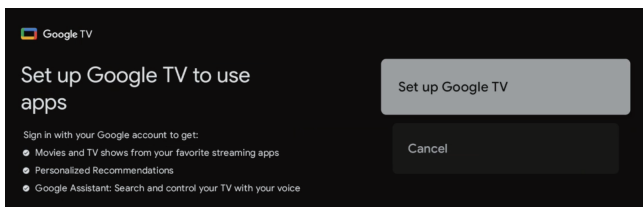

Press ▲/▼ to select the "Set up Google TV" of your device and press OK to complete the setup.

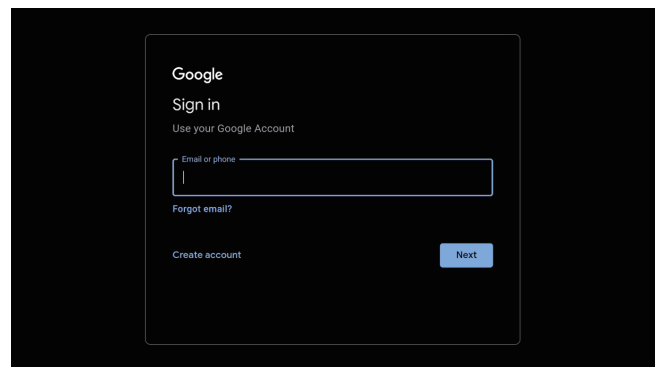

Use your Google Account Sign in

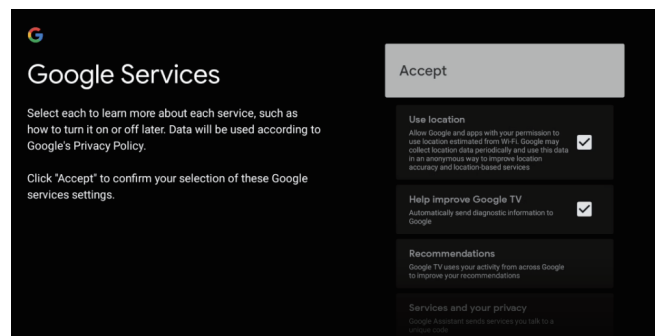
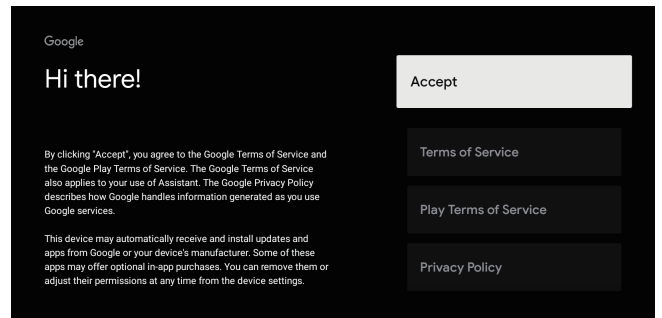

By accepting the Google Terms of Service to improve the product experience, select "Accept" to accept this condition.

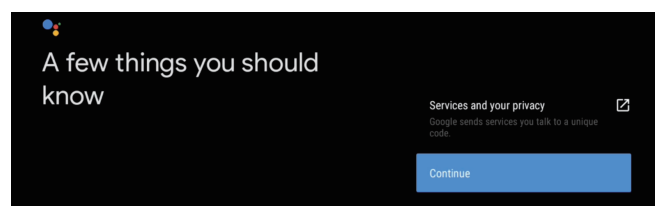
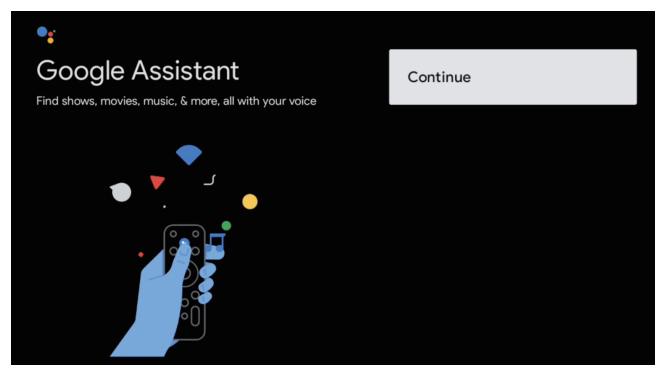

Press to select and press OK to continue.

OPERATING INSTRUCTIONS

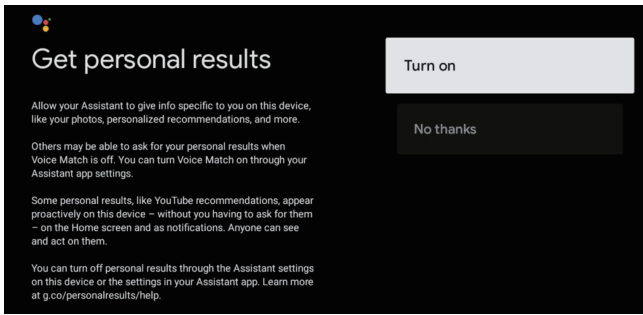

Press ▲/▼ to select the Get personal results and press OK to setup.

NOTE:

The content of this page will vary depending on the country selected by the Boot Wizard.

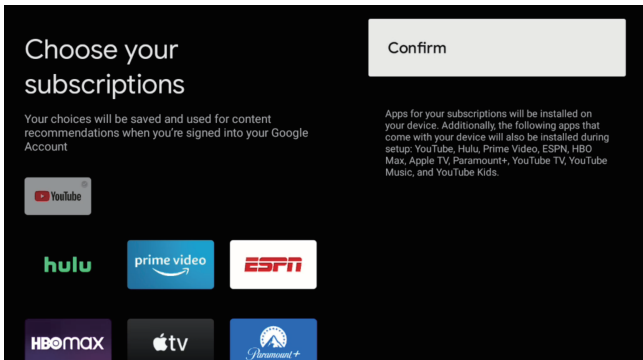

Press ▲/▼ to select the Choose your subscriptions and press OK .

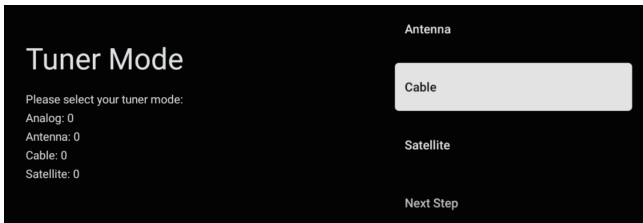

To select the Tuner mode for searching, press to select and press OK to confirm

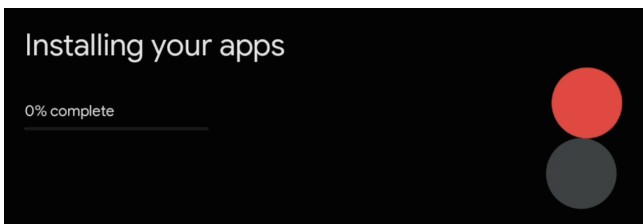

Press the next step Installing your apps.

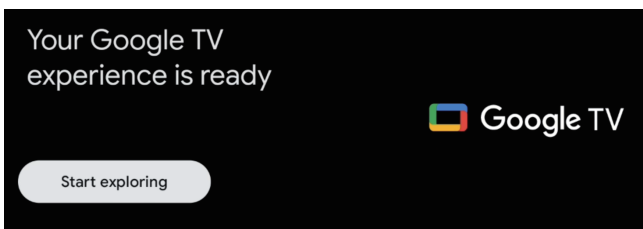

Your Google TV experience is ready and press OK to Start exploring.

HOME SCREEN

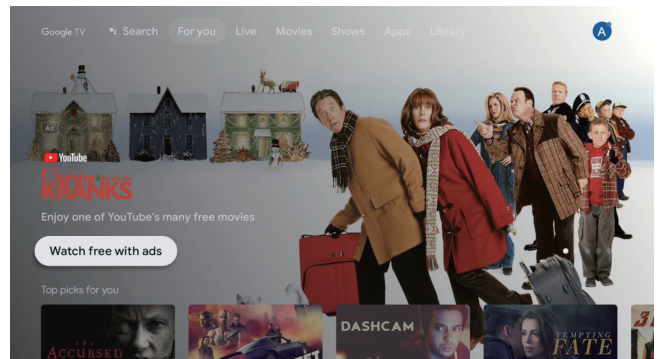

After completing the wizard Settings, you can watch TV and go to the home screen.

NAVIGATING THE ON-SCREEN MENU

There are two ways to enter. First, in live TV, press the menu button to display TV options, press ▲/▼/◀/▶ to select the settings menu and press OK to confirm.

Second, in the HOME interface, press the key ► to select the icon of the circular settings menu, press OK to confirm.

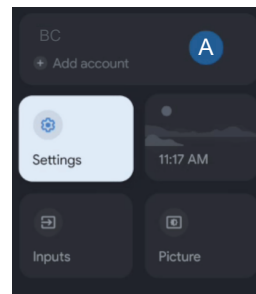
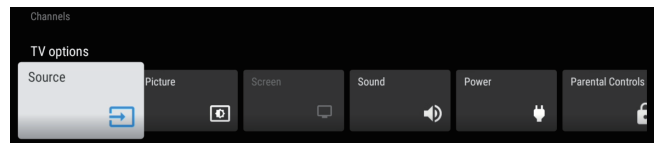

Press ▲/▼ button to select what you want set. Press OK to enter setting.

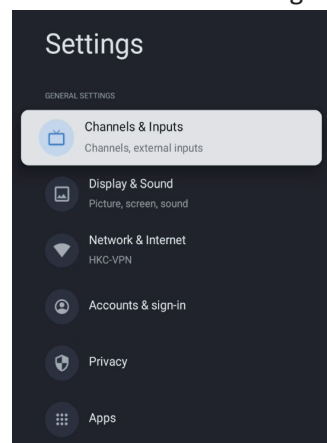

Press BACK to return to the previous menu. If the main menu is displayed, pressing BACK will close the onscreen menu.

OPERATING INSTRUCTIONS

Network

1. Press ▲/▼ button to select what you want set.
2. Press OK button to adjust.
3. After finishing your adjustment, Press OK button to save and return to the pervious menu.

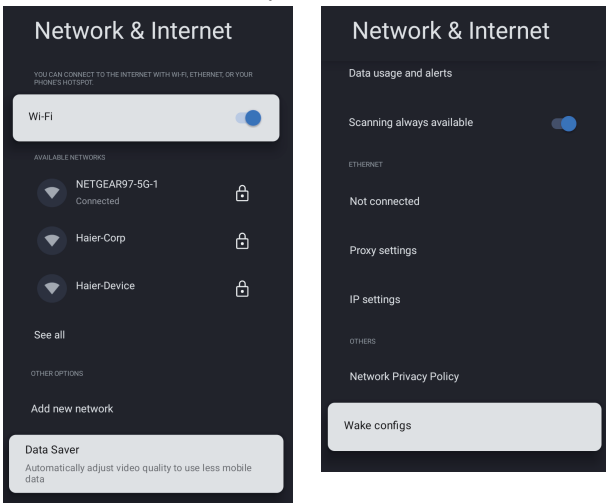

Channel & Inputs

Press ▲/▼ button to select “Channel & Inputs” set.

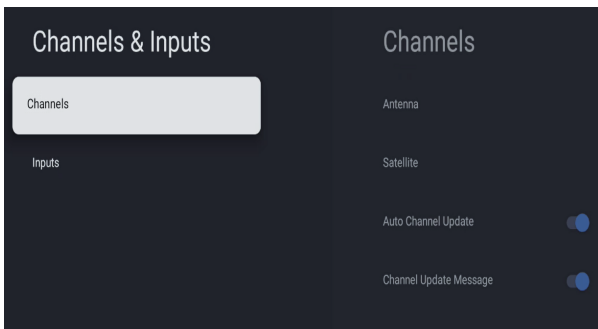

CHANNEL

In the HOME interface, select the "Settings" icon, press OK to open the input source list, select the “Antenna”.

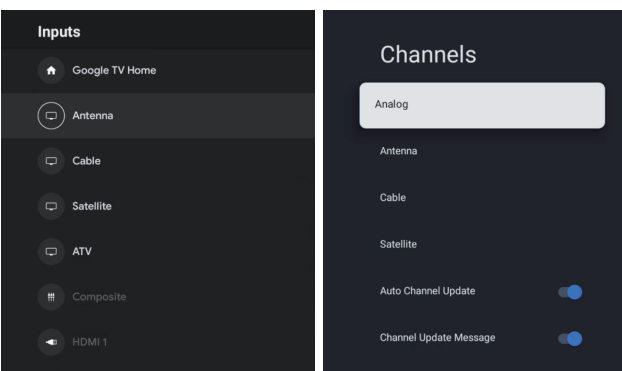

Analog/Antenna/Cable/Satellite - Press ▲/▼ button to select the option then press OK button to enter the sub-menu.

Auto Channel Update - Press OK button to choose **ON/OFF**. When selecting ON, the system will automatically scan and update channels after 5 minutes of standby.

Channel Update Message - Press OK button to choose **ON/OFF**. When selecting ON, the system will show you the update message.

Antenna(Analog)

1. Menu->Settings->Channel & Inputs->Antenna->Channels.

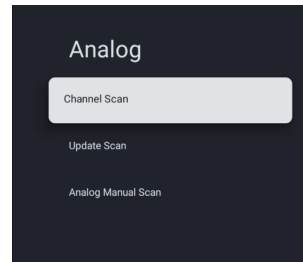

2. Enter Menu->Settings->Channel->Channels.



3. Channel Scan directly enters the automatic search platform interface.

Update Scan: Re-automatically search for frequency points outside the station.

Analog Manual Scan: Manual ATV search station. After input the frequency point, you can select up or down search station.

Antenna(Antenna)

1. Menu->Settings->Channel->Channels.

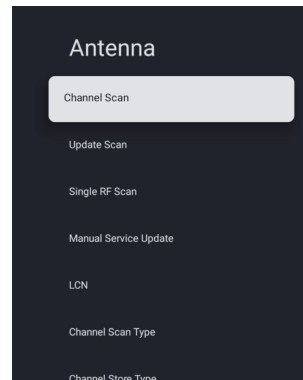

2. Enter Menu->Settings->Channel->Channels.



3. Channel Scan directly enters the DTV automatic search platform interface of Antenna.

Update Scan: Re-automatically search for frequency points outside the station.

Single RF Scan: DTV manual search, left and right after selecting RF Channel, directly OK search.

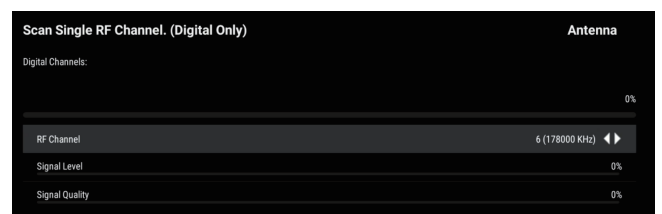

OPERATING INSTRUCTIONS

Antenna(Cable)

1. Menu->Settings->Channel & Inputs->Antenna->Channels.

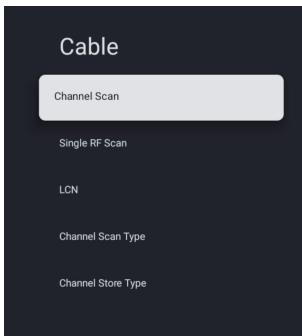

2. Enter Menu->Settings->Channel->Channels->Channel Scann.



3. Enter Channel Scan, where Akado, Divan TV, Online and Rostelecom (SPB) are the local operators, and the default Scan Mode is Advance; Others have Advance, Quick and Full Scan modes.

Single RF Scan: manual search station.

Antenna(Satellite)

1. Menu->Settings->Channel->Channels.

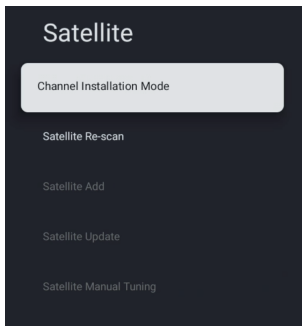

Channel Installation Mode: Press ▲/▼ button to select Preferred Satellite/General Satellite.

2. Enter Menu->Settings->Channel->Channels->Satellite Re-scan.

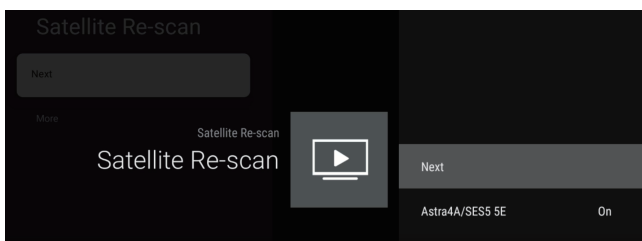

3. Press OK to enter Satellite parameter Settings, which include LNB POWER, LNB Frequency, DiSEqC Set, 22K and other parameters. Then return to Satellite re-scan and right click to enter the search menu. Then return to Satellite re-scan and right click to enter the search menu.

Satellite Add: Add a star broadcast signal.

Satellite Manual Tuning: manually search for a certain TP which can be added by Satellite Add if needed.

Inputs

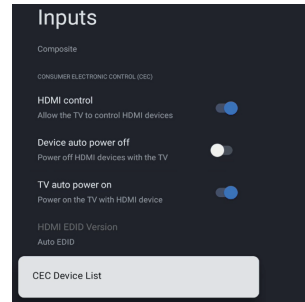
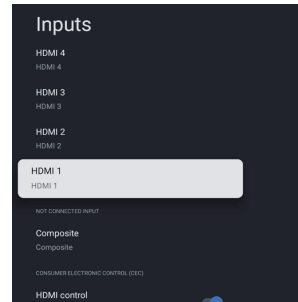

Inputs - Press ▲/▼ button to select the option then press OK button to enter the sub-menu.

HDMI control - Press ▲/▼ button to select the option then press OK button to choose ON/OFF.

Device auto power off - Press ▲/▼ button to select the option then press OK button to choose ON/OFF.

TV auto power on - Press ▲/▼ button to select the option then press OK button to choose ON/OFF.

HDMI EDID Version - show EDID version.

CEC Device List - Press ▲/▼ button to select the option then press OK button to enter the sub-menu.

Display & Sound

Press ▲/▼ button to select "Display & Sound" set.

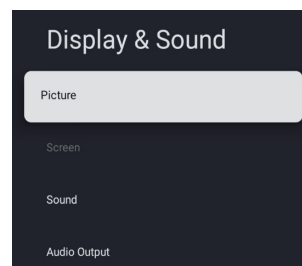

Picture

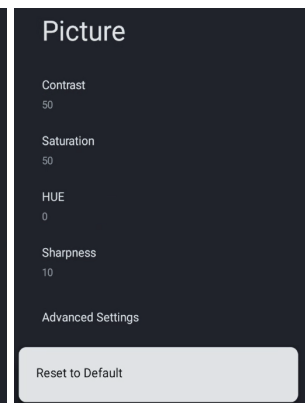
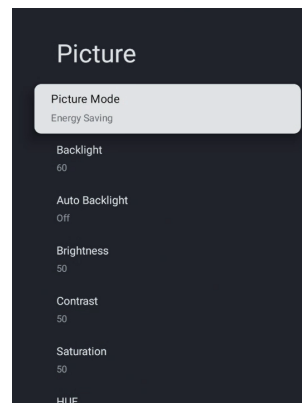

OPERATING INSTRUCTIONS

Picture Mode - Press ▲/▼ button to select the option button to enter the sub-menu.(Optional: user, Standard, Vivid, Sport, Movie, Game, Energy saving).

Backlight/Brightness/Contrast/Saturation/HUE/Sharpness - Press ▲/▼ button to select the option. Press ◀ to decrease the parameter. Press ▶ to increase the parameter.

Auto Backlight - Press ▲/▼ button to select the ON/OFF.

Advanced Video - Press ▲/▼ button to select the option then press OK button to enter the sub-menu.

Reset to Default-Reset all settings to the factory defaults.

Sound

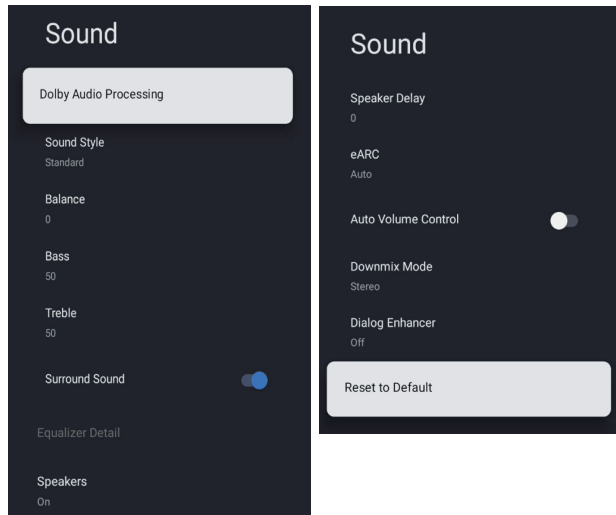

Dolby Audio processing - Press▲/▼ button to select the option then press OK button to choose ON/OFF.

Sound style - Press▲/▼ button to select the option then press OK button to enter the sub-menu.(Optional: user, Standard, Night, Sports, Movie, Music, News).

Balance/Bass/Treble - Press ▲/▼ button to select the option. Press ◀ to decrease the parameter. Press ▶ to increase the parameter.

dbx-tv - Press▲/▼ button to select the option then press OK button to enter the sub-menu.

Sound Surround - Press▲/▼ button to select the option then press OK button to choose ON/OFF.

Equalizer Detail - Press▲/▼ button to select the option then press OK button to enter the sub-menu.

Speakers - Press▲/▼ button to select the option then press OK button to choose Auto/OFF.

Speaker Delay - Press▲/▼ button to select the option. Press ◀ to decrease the parameter. Press ▶ to increase the parameter.

eARC - Press▲/▼ button to select the option, then press OK button to choose Auto/OFF.

Auto Volume Control - Press▲/▼ button to select the option then press OK button to choose ON/OFF.

Downmix Mode - Press▲/▼ button to select the option then press OK button to enter the sub-menu.(Optional: Stereo, Surround).

Dialogue Enhancer - Press ▲/▼ button to select the option then press OK button to choose Off/Low/Medium/High.

Reset to Default - Reset all settings to the factory defaults.

Audio Output

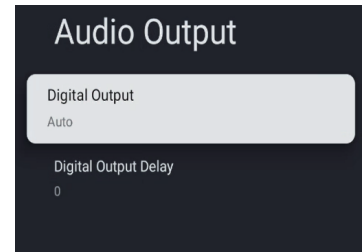

In this menu, you can read the information and settings of Audio Output.

1. Press ▲/▼ button to select what you want set.
2. Press OK button to adjust.
3. After finishing your adjustment, Press BACK button return to the previous menu.

Digital Output - Press ▲/▼ button to select the option then press OK button to enter the sub-menu.(Optional: Auto, Bypass, PCM Dolby Digital Plus, Dolby Digital).

Digital Output Delay - Press▲/▼ button to select the option.Press to decrease the parameter.Press to increase the parameter.

Accounts & Sign in

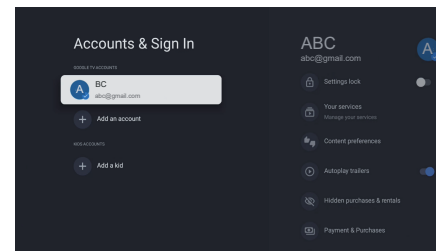

Privacy

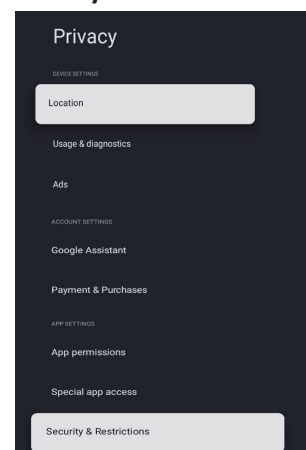

In this menu, you can read the information and settings of Privacy.

1. Press ▲/▼ button to select what you want set.
2. Press OK button to adjust.
3. After finishing your adjustment, Press BACK button return to the previous menu.

OPERATING INSTRUCTIONS

Apps

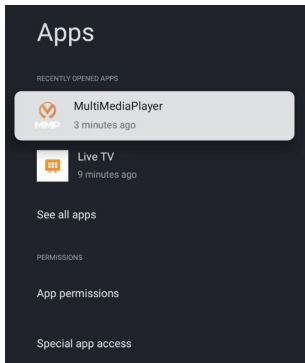

In this menu, you can set the APP permissions, and read the app lists.

1. Press ▲/▼ button to select what you want set.
2. Press OK button to adjust.
3. After finishing your adjustment, press BACK button to return to the previous menu.

System

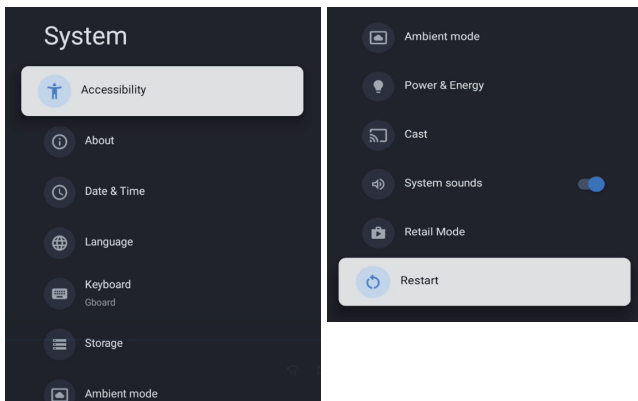

Accessibility

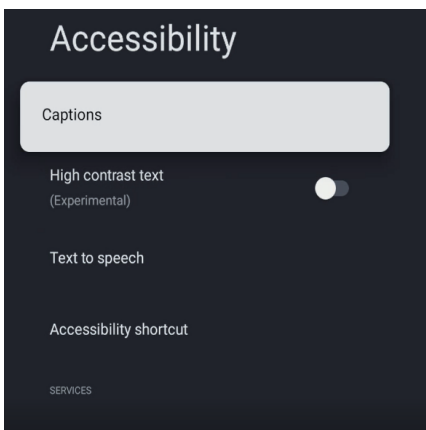

Captions - Press ▲/▼ button to select the option then press OK button to enter the sub-menu.

High contrast test - Press ▲/▼ button to select the option then press OK button to choose ON/OFF.

Text to speech - Press ▲/▼ button to select the option then press OK button to enter the sub-menu.

Accessibility shortcut - Press ▲/▼ button to select the option then press OK button to enter the sub-menu.

SERVICES - Press ▲/▼ button to select the option then press OK button to enter the sub-menu.

About

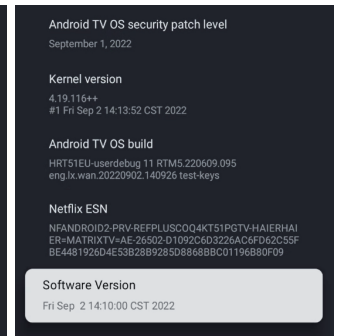
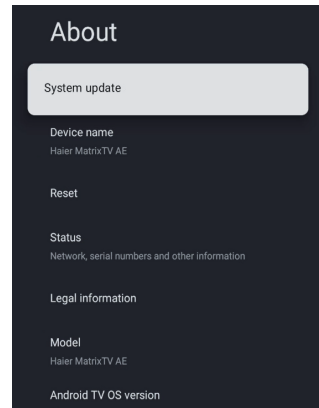

In this menu, you can System update, Factory reset and read the information of TV.

Date & Time

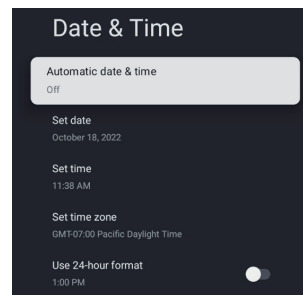

Automatic date time - Press ▲/▼ button to select the option then press OK button to enter the sub-menu. (Optional: Use network-provided time, Off)

NOTE

- Manually adjusting date time settings will automatically change the Automatic date time to OFF.

Set date - Press ▲/▼ button to select the option then press OK button to enter the sub-menu.

Set time - Press ▲/▼ button to select the option then press OK button to enter the sub-menu.

Set time zone - Press ▲/▼ button to select the option then press OK button to enter the sub-menu.

Use 24-hour format - Press ▲/▼ button to select the option then press OK button to choose ON/OFF.

Language

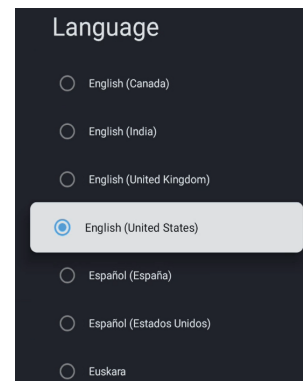

Language - Press ▲/▼ button to select the option then press OK button to enter the select language.

OPERATING INSTRUCTIONS

Keyboard

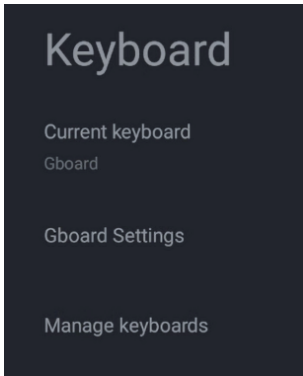

Current keyboard - Press ▲/▼ button to select the option then press OK button to enter the sub-menu.

Gboard Settings - Press ▲/▼ button to select the option then press OK button to enter the sub-menu.

Manage keyboards - Press ▲/▼ button to select the option then press OK button to enter the sub-menu.

Storage

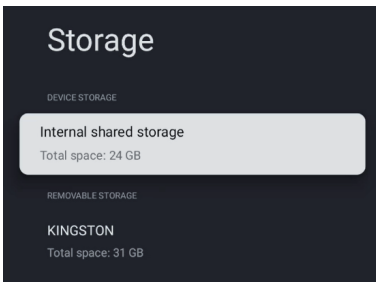

Internal shared storage - Press ▲/▼ button to select the option then press OK button to enter the sub-menu.

KINGSTON - Press ▲/▼ button to select the option then press OK button to enter the sub-menu.

Ambient mode

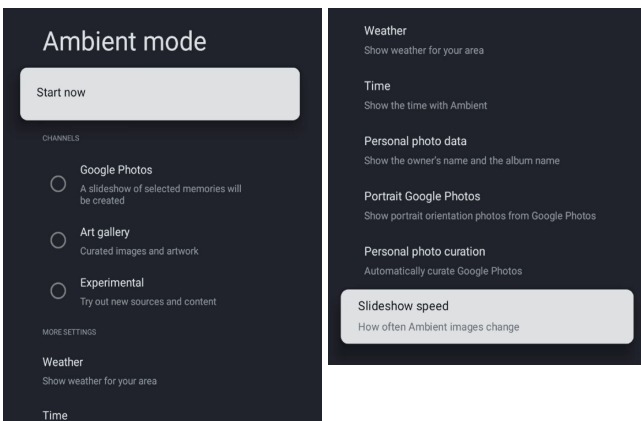

In this menu, you can read the information and settings of Ambient mode.

1. Press ▲/▼ button to select what you want set.

2. Press OK button to adjust.

3. After finishing your adjustment, Press BACK button return to the previous menu.

Power & Energy

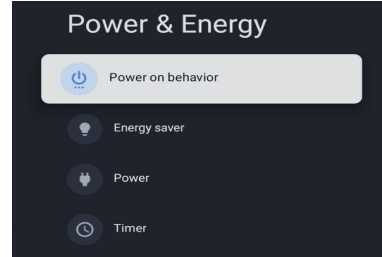

In this menu, you can set Power on behavior, Energy saver, Power, Timer.

1. Press ▲/▼ button to select what you want set.

2. Press OK button to adjust.

3. After finishing your adjustment, Press BACK button return to the previous menu.

Cast

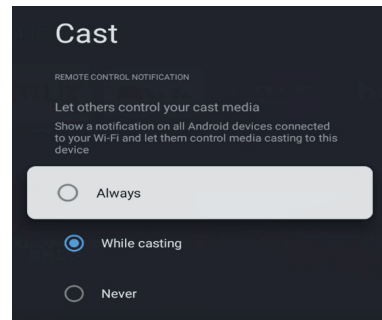

Press ▲/▼ button to select the option then press OK button to choose Always/While casting/Never.

System sounds

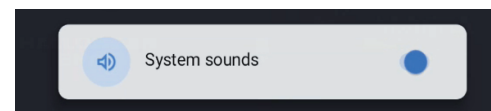

Press ▲/▼ button to select the option then press OK button to choose ON/OFF.

Retail Mode

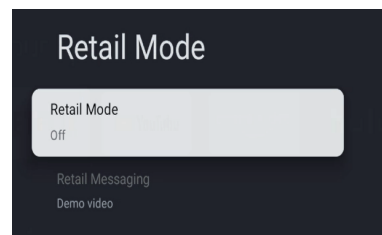

Retail mode - Press ▲/▼ button to select the option then press OK button to choose ON/OFF.

Retail messaging - Press ▲/▼ button to select the option then press OK button to enter the sub-menu.

(Note: Demo video, e-POP left, e-POP bottom)

OPERATING INSTRUCTIONS

Factory reset

Press OK button to enter the sub-menu. Reset-Erase everything.

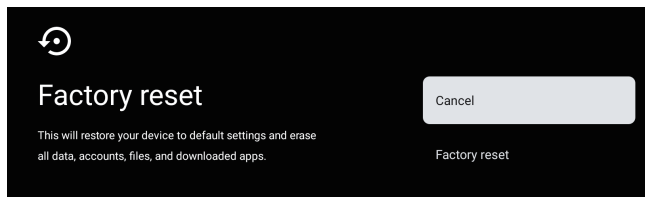

Remotes & Accessories

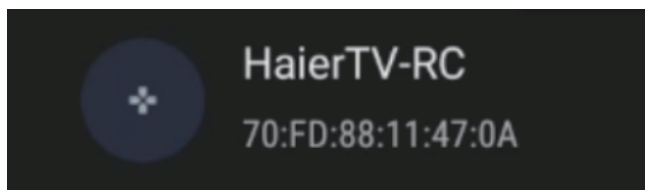
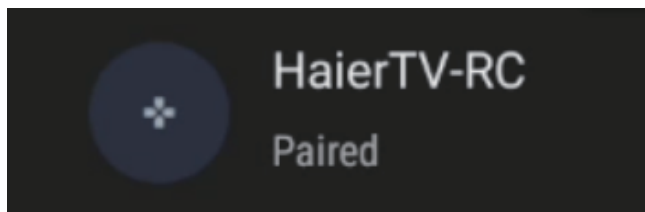
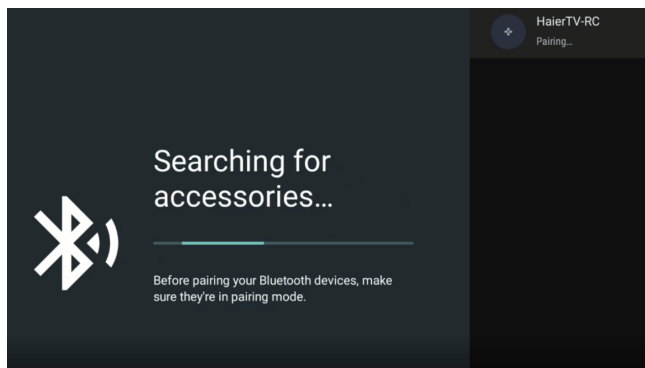

In this menu, you can pair Bluetooth devices.

1. Press the "←" and "TV" buttons at the bottom of the remote control for 5 seconds.
2. When the LED starts to flash, release it. The remote controller will send the pairing signal to the TV and display the information of the remote control on the right side of the screen.
3. Press the OK button to display the pairing. If the paired is displayed, the connection is successful.
4. If the couldn't pair appears, the connection fails. Wait 30 seconds and then press the "←" and "TV" buttons at the bottom of the remote control for 5 seconds to repeat the previous steps.
5. Press "←" button return to the previous menu.

ADD AND USE OF MULTI MEDIA PLAYER

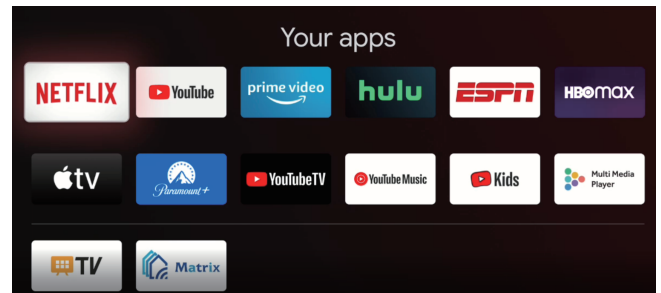
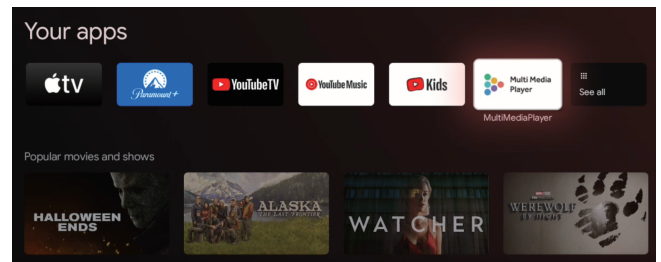

1. In the HOME interface, select the icon in the APP column to add the application, and click OK. Press up and down to select the MultiMediaPlayer application, and click OK to add it to the HOME interface.

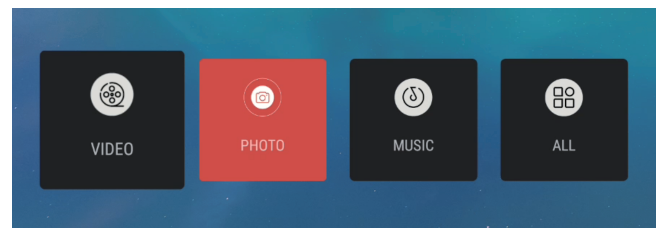

2. Select OK key to enter Multi Media Player and display Video, Photo, Audio. After inserting the usb flash drive, you can view the corresponding files in the usb flash drive (FAT32 Format).

NOTE

The menu may be different depending on when you purchased the TV.

HANDS FREE VOICE CONTROL

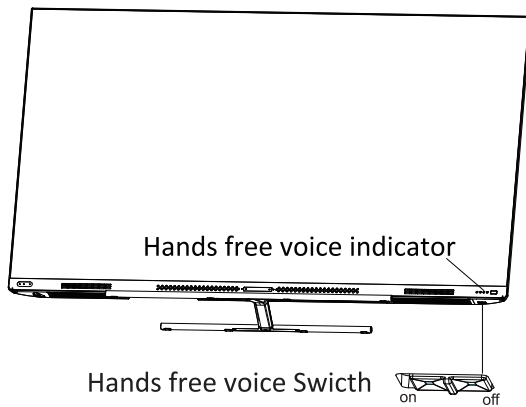

NOTE

- This feature requires network support. When the network fails or is restricted, try manually setting the current network date and time.

5.Supported Far Field Assistant locales

en-US/es-US, fr-FR, es-ES, ja-JP, ko-KR, de-DE, it-IT, en-GB, en-AU, en-IN/hi-IN, en-CA/fr-CA, es-MX, pt-BR, id-ID, sv-SE, vi-VN

Switch to the left to open the Hands free Voice Control, and to the right to close.

Switch to the left to open the Hands free Voice Control, and to the right to close.

- 1.Move the switch toward the center of the screen.
(Open by default)

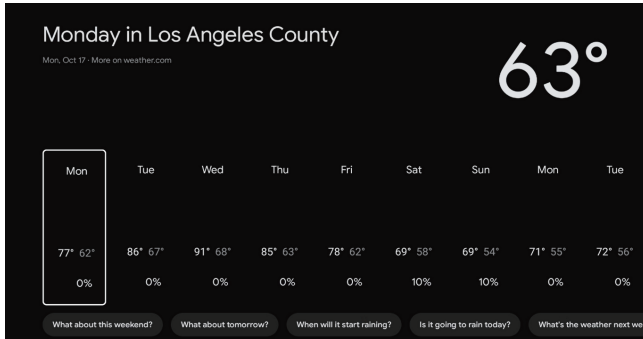
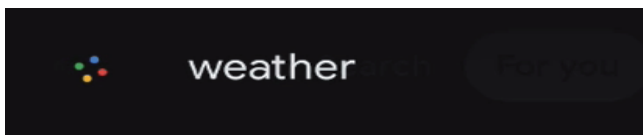
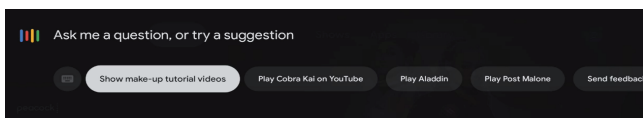

2. Operate the remote control and click the microphone icon. Select settings Google assistant, and select sign in or use assistant without sign in—Allow

3. Continue to click the microphone icon to conduct voice interaction through the wake-up word "Ok Google".

4. Click the microphone icon again. When the prompt "Google assistant is not ready!" is prompted, the system starts the voice module. After the prompt disappears, it can be used. For example, when we say "Ok Google, weather", Hands free voice indicator will light up and feed back the weather conditions.

TROUBLESHOOTING

Please make these simple checks before calling service. These tips may save you time and money since charges for receiver installation and adjustments of customer controls are not covered under your warranty.

Symptoms	Items to Check and Actions to Follow
"Ghost" or double image	<ul style="list-style-type: none"> This may be caused by obstruction to the antenna due to high rise buildings or hills. Using a highly directional antenna may improve the picture.
No power	<ul style="list-style-type: none"> Check if the TV's AC power cord is plugged into the outlet. Unplug the TV, wait for 60 seconds. Then reinsert plug into the outlet and turn on the TV again.
No picture	<ul style="list-style-type: none"> Check antenna connections at the rear of the TV to see if it is properly connected to the TV. Possible broadcast station trouble. Try another channel. Adjust the contrast and brightness settings. Check the Closed Captions control. Some TEXT modes could block the screen.
Good picture but no sound	<ul style="list-style-type: none"> Increase the volume level by pressing the VOL+ button on the remote control or on the TV side control panel. Press the MUTE button on the remote control to ensure mute is off.
Good sound but poor color	<ul style="list-style-type: none"> Adjust the contrast, color and brightness settings.
Poor picture	<ul style="list-style-type: none"> Poor picture quality may occur when an activated S-VHS camera or camcorder is connected to your TV and other peripherals at the same time. Switch off one of the peripherals.
Snowy picture and noise	<ul style="list-style-type: none"> Check the antenna connection.
Horizontal dotted line	<ul style="list-style-type: none"> This may be caused by electrical interference (e.g. hair dryer, nearby neon lights, etc.) Turn off the equipment.
Television not responding to remote control	<ul style="list-style-type: none"> Check whether the batteries are working. Replace if necessary. Clean the remote control sensor lens on the TV. You can still use the buttons on the side of your TV.
Pixels (dots) that are always dark or always lit	<ul style="list-style-type: none"> Your TV is precision-manufactured using an extremely high level of technology. However, sometimes pixels may not display correctly. These types of occurrences are inherent to this type of product and do not constitute a defective product.

NOTE

• This product uses a panel consisting of sub pixels which require sophisticated technology to produce. However, there may be a few bright or dark pixels on the screen. These pixels will have no impact on the performance of the product.



Dolby, Dolby Vision, Dolby Atmos, and the double-D symbol are registered trademarks of Dolby Laboratories Licensing Corporation. Manufactured under license from Dolby Laboratories. Confidential unpublished works. Copyright © 2012–2022 Dolby Laboratories. All rights reserved.

PRODUCT SPECIFICATION

55" UHD Digital LED LCD TV

Television picture quality:	UHD Integrated digital. Screen Size: 139 cm Resolution 3840x2160 pixels 120Hz.
TV System:	PAL-B/G,SECAM-B/G
DTV Tuner Decoder	DVB-T, DVB-C, DVB-T2, DVB-S2 16/32/64/128/256 QAM modulation MPEG2,MPEG4,H.265
Connectivity:	1 Optical port 2 USB ports 1 RJ45 4 HDMI sockets 1 VIDEO socket 1 L socket 1 R socket 2 RF sockets 1 EARPHONE port 1 CI slot Supported Systems:PAL+SECAM TV (RF) :75 Ω Imbalance AV Video-Input:75 Ω ,1V-P,RCA AV Audio-Input:20K Ω ,500mV RMS HDMI Video Input: 480i, 480p, 720p, 1080i, 1080p,2160p WiFi : Standard: IEEE 802.11a/b/g/n/ac ,Frequency: 2.4GHz/5GHz Bluetooth:V5.1
Sound quality:	Stereo sound system. 2x13.5 watts RMS power output. dbx-tv
Standby Power consumption	≤0.5W
Digital features:	Digitally interactive. Digital text. Digital video broadcasting (DVB) subtitles available. Auto setup. Auto scan for new channels. Now and next programme guide. 7 day electronic programme guide (EPG). Top up TV compatible. CI slot. Audio description compatible.
Additional features:	UHF/VHF tuner;Sleep timer;Parental Guidance;Picture and text Remote control batteries required 2 x AAA. VESA Mount Size: 200x200mm Package Size (WxHxD): 1360x860x150mm Set Size (WxHxD) with Stand: 1229x782x255mm Set Size (WxHxD) without Stand: 1229x730x68mm Package weight : 20.5kg Set weight with stand: 16.4kg Set weight without stand: 15.2kg

* The part specifications of this TV set provided here are for reference only.
Differences may occur as product technology is updated.
Design and specifications are subject to change without notice.

PRODUCT SPECIFICATION

65" UHD Digital LED LCD TV

Television picture quality:	UHD Integrated digital. Screen Size: 165 cm Resolution 3840x2160 pixels 120Hz.
TV System:	PAL-B/G,SECAM-B/G
DTV Tuner Decoder	DVB-T, DVB-C, DVB-T2, DVB-S2 16/32/64/128/256 QAM modulation MPEG2,MPEG4,H.265
Connectivity:	1 Optical port 2 USB ports 1 RJ45 4 HDMI sockets 1 VIDEO socket 1 L socket 1 R socket 2 RF sockets 1 EARPHONE port 1 CI slot Supported Systems:PAL+SECAM TV (RF) :75 Ω Imbalance AV Video-Input:75 Ω ,1V-P,RCA AV Audio-Input:20K Ω ,500mV RMS HDMI Video Input: 480i, 480p, 720p, 1080i, 1080p,2160p WiFi : Standard: IEEE 802.11a/b/g/n/ac ,Frequency: 2.4GHz/5GHz Bluetooth:V5.1
Sound quality:	Stereo sound system. 2x13.5 watts RMS power output. dbx-tv
Standby Power consumption	≤0.5W
Digital features:	Digitally interactive. Digital text. Digital video broadcasting (DVB) subtitles available. Auto setup. Auto scan for new channels. Now and next programme guide. 7 day electronic programme guide (EPG). Top up TV compatible. CI slot. Audio description compatible.
Additional features:	UHF/VHF tuner;Sleep timer;Parental Guidance;Picture and text Remote control batteries required 2 x AAA. VESA Mount Size: 400x200mm Package Size (WxHxD): 1615x1015x185mm Set Size (WxHxD) with Stand: 1448x906x295mm Set Size (WxHxD) without Stand: 1448x851x68mm Package weight : 27.9kg Set weight with stand: 21.1kg Set weight without stand: 19.6kg

* The part specifications of this TV set provided here are for reference only.
Diferences may occur as product technology is updated.
Design and specifications are subject to change without notice.

Haier

美工资料		HKC 惠科股份有限公司 HKC Corporation Limited			
料号		物料名称	说明书	版本	V01
国家/订单		工厂型号	55 65vx	客户型号	
规格		比例	1:1	客户品牌	海尔
设计	sujiain	核准		日期	2024.6.18
材质	80g书纸, 黑白印刷, 骑马订 142*205				
备注说明					