

Série Q80

H55Q80FUX



- ✓ Optimisé pour le gaming à 120 Hz
- ✓ Google TV et télécommande intelligente
- ✓ Processeur puissant et grande capacité de mémoire
- ✓ Dolby Atmos
- ✓ QLED 4K

Caractéristiques principales

Référence commerciale	H55Q80FUX
Code produit	36200116
Code EAN	6976454834079
Fabricant	Qingdao Haier Optronics Co. Ltd.
Taille d'écran (pouces)	55
Technologie de dalle utilisée	QLED
Résolution	3840*2160
Définition de la dalle	4K

Caractéristiques techniques

Application disponible	hOn
------------------------	-----

Ecran

Type de panneau	D-LED
Surface d'écran active (pouces)	54,6

Taux de rafraîchissement	60Hz
HDR10	Oui
Dolby Vision	Oui
Modes d'image multiples	User
Économie d'énergie	Oui
MEMC	Oui
Gamme de couleurs	QLED
Diagonale d'écran (cm)	139

TV Connectée

Smart TV	Google TV
Système	Google TV
Applications - Google Play Store	Oui
Applications - Google Assistant	Oui
Commande vocale en champ lointain	FFGA (Far field with Google Assistant)
Chromecast	Oui
Mode Hôtel	Non
HbbTV	Yes (function only)

Son

Son surround (simulation)	Oui
dbx-tv	Oui
Dolby Atmos	Oui
Watts/canal (7 % THD)	2* 9,5W + 2* 15W Speaker
Modes audio multiples	User

Connectivité

Entrée HDMI	4* HDMI 2.1 ALLM VRR eARC Compliant
Entrée tuner	2
Prise casque	1
Ports USB	2 (USB 2.0)

Bluetooth	5.1
Wi-Fi	Wi-Fi 5,dual-band(2.4 GHz/5GHz), 2T2R, 802.11 a/b/g/n/ac
Entrée composite	1
Entrée audio partagée	1 (Shared with Composite Input)
Port Ethernet LAN	1

Performance et consommation

Classe d'efficacité énergétique	F
Consommation en mode marche SDR (W)	77
Classe d'efficacité énergétique en mode HDR (High Dynamic Range)	G
Consommation en mode marche HDR (W)	110

Dimensions

Profondeur du produit emballé (mm)	144
Largeur du produit emballé (mm)	1350
Standard de fixation murale (VESA) [mm]	300x300
Hauteur du produit (mm)	777,3
Hauteur du produit emballé (mm)	837
Poids net (kg)	11,8
Poids net (sans pied)	11,3
Poids brut (kg)	15,6

Haier

Inspired Living

User Manual

MODELS:

H43Q80FUX

H50Q80FUX

H55Q80FUX

H65Q80FUX

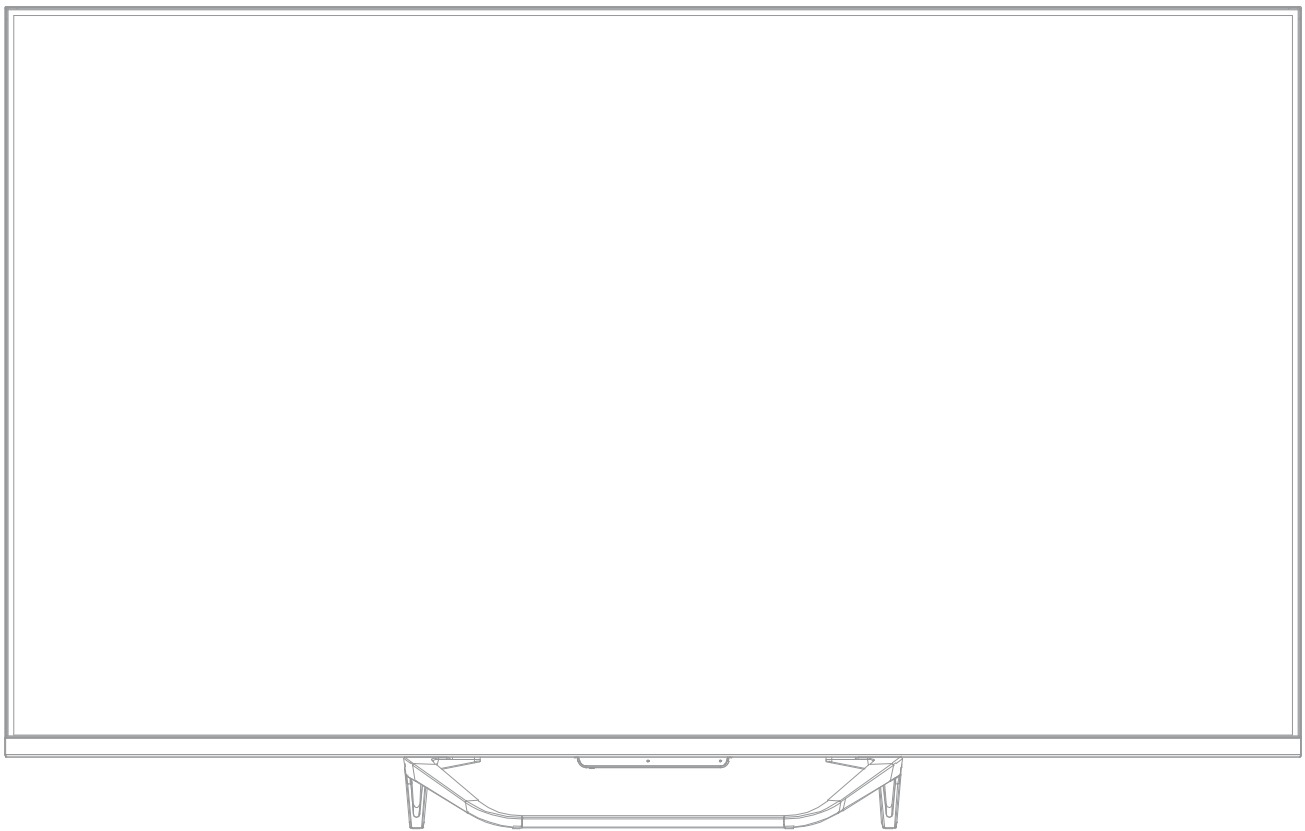

Illustration in this guide are provided for reference only and may differ from actual product appearance. Product design and specification may be changed without notice.

LED Television

TABLE OF CONTENTS

1. IMPORTANT SAFETY INSTRUCTIONS	1
2. PREPARATION	3
3. PERIPHERAL CONNECTION AND CONTROLS	4
4. MAKING CONNECTIONS.....	5
5. OPERATING INSTRUCTIONS	6
6. TROUBLESHOOTING	18
7. PRODUCT SPECIFICATION	19



Illustration in this guide are provided for reference only and may differ from actual product appearance. Product design and specification may be changed without notice.

IMPORTANT SAFETY INSTRUCTIONS

- 1) Read these instructions.
- 2) Keep these instructions.
- 3) Heed all warnings.
- 4) Follow all instructions.
- 5) Do not use this apparatus near water.
- 6) Clean only with dry cloth.
- 7) Do not block any ventilation openings, install in accordance with the instructions.
- 8) Do not install near any heat sources such as radiations, heat registers, stoves, or other apparatus (including amplifiers) that produce heat.
- 9) Do not defeat the safety purpose of the polarized plug. If the provided plug does not fit into your outlet, consult an electrician for replacement of the obsolete outlet.
- 10) Protected the power cord from being walked on or pinched particularly at plugs, convenience receptacles, and the point where they exit from the apparatus.
- 11) Only use attachments/accessories specified by the manufacturer.
- 12) Unplug this apparatus during lighting storms or when unused for long periods of time.
- 13) Refer all servicing to qualified service personnel. Servicing is required when the apparatus has been damaged in any way, such as power-supply cord or plug is damaged, liquid has been spilled or objects have fallen into the apparatus, the apparatus has been exposed to rain or moisture, does not operate normally, or has been dropped.
- 14) Mains plug is used as the disconnect device, the disconnect device shall remain readily operable.
- 15) The ventilation should not be impeded by covering the ventilation openings with items, such as newspapers, table-cloth, curtains, etc.
- 16) No naked flame sources, such as lighted candles, should be placed on the apparatus.
- 17) Attention should be drawn to the environmental aspects of battery disposal.
- 18) The use of apparatus in moderate climate.
- 19) The apparatus shall not be exposed to dripping or splashing and that no objects filled with liquids, such as vases, shall be placed on the apparatus.
- 20) warning: To avoid any injury caused by lean of the product, please always ensure the whole product was placed within the table surface in horizontal.

Actual product may vary in appearance from above image

Where a plug on the power supply cord is used as the disconnect device, the installation instructions shall state that for pluggable equipment, the socket-outlet shall be easily accessible.

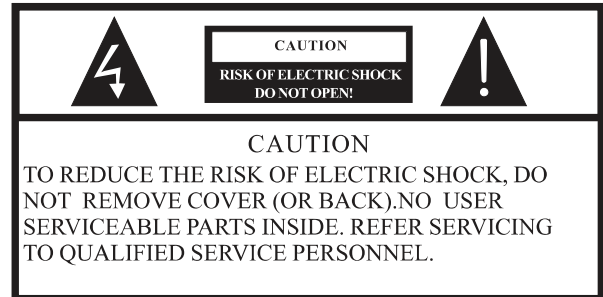

 The symbol indicates that dangerous voltages constituting a risk of electric shock are present within this unit.

 The symbol indicates that there are important operating and maintenance instructions in the literature accompanying this unit.

WARNING:
To reduce the risk of fire or electric shock, do not expose this apparatus to rain or moisture.

WARNING:
The batteries shall not be exposed to excessive heat such as sunshine, fire or the like.



This symbol indicates that this product incorporates double insulation between hazardous mains voltage and user accessible parts. When servicing use only identical replacement parts.



This marking indicates that this product should not be disposed with other household wastes. To prevent possible harm to the environment or human health from uncontrolled waste disposal, recycle it responsibly to promote the sustainable reuse of material resources. To return your used device, please use the return and collection systems or contact the retailer where the product was purchased. They can take this product for environmental safe recycling.

IMPORTANT SAFETY INSTRUCTIONS

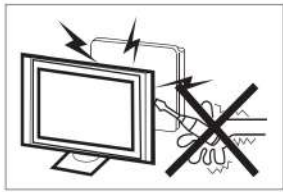

High voltages are used in the operation of this television receiver. Do not remove the cabinet back from your set. Refer servicing to qualified service personnel.

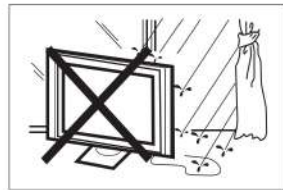

To prevent fire or electrical shock hazard, do not expose the television receiver to rain or moisture.



Do not drop or push objects into the television cabinet slots or openings. Never spill any kind of liquid on the television receiver.



Do not block the ventilation holes in the back cover. Adequate ventilation is essential to prevent failure of electrical components.



Do not trap the power supply cord under the television receiver.



If you are going to clean the product, Unplug the TV, use soft fabric, no water, never chemicals.

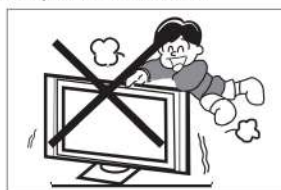

Never stand on, lean on, or suddenly push the television or its stand. You should pay special attention to children. Serious injury may result if it falls.

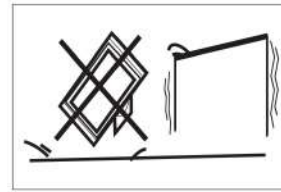

Do not place your television on an unstable cart, stand, shelf or table. Serious injury to an individual, and damage to the television, may result if it falls.



When the television receiver is not used for an extended period of time, it is advisable to disconnect the AC power cord from the AC outlet.



Avoid exposing the television receiver to direct sunlight and other sources of heat. Do not stand the television receiver directly on other products which give off heat, e.g. video cassette players and audio amplifiers. Do not place naked flame sources, such as lighted candles on the television.

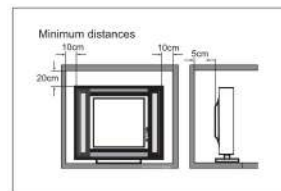

If the television is to be built into a compartment or similar enclosure, the minimum distances must be maintained. Heat build-up can reduce the service life of your television, and can also be dangerous.

Note: the use of apparatus in moderate climates.

Caution:

A television set may fall, causing serious personal injury or death. Many injuries, particularly to children, can be avoided by taking simple precautions such as:

- ALWAYS use cabinets or stands or mounting methods recommended by the manufacturer of the television set.
- ALWAYS use furniture that can safely support the television set.
- ALWAYS ensure the television set is not overhanging the edge of the supporting furniture.
- ALWAYS educate children about the dangers of climbing on furniture to reach the television set or its controls.
- ALWAYS route cords and cables connected to your television so they cannot be tripped over, pulled or grabbed.
- NEVER place a television set in an unstable location.
- NEVER place the television set on tall furniture (for example, cupboards or bookcases) without anchoring both the furniture and the television set to a suitable support.
- NEVER place the television set on cloth or other materials that may be located between the television set and supporting furniture.
- NEVER place items that might tempt children to climb, such as toys and remote controls, on the top of the television or furniture on which the television is placed.

If the existing television set is going to be retained and relocated, the same considerations as above should be applied.

PREPARATION

IMPORTANT: Do not apply pressure to the screen display area which may compromise the integrity of the display. The manufacturer's warranty does not cover user abuse or improper installations.

ATTACHING THE STAND

IMPORTANT: The stand of the TV must be assembled prior to usage.

1. Place TV unit face down on a soft and flat surface (blanket, foam, cloth, etc.) to Prevent any damage to the TV.
2. Fix the stand to the bottom of the TV with the 6 screws.

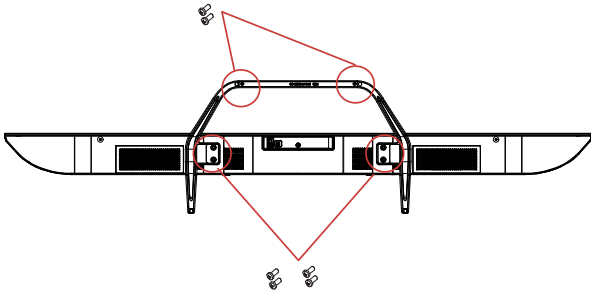

NOTE
The appearance of the product shall be in kind.

PREPARING YOUR LED TV FOR WALL MOUNTING

We suggest that you keep your TV at least 2.36 inches (60 mm) from the wall to prevent cable interference. Before mounting your TV on the wall, you need to remove the stand.

For your safety, please use only with a UL listed wall mount bracket with minimum weight of the TV without stand.

To attach a wall mount bracket to your TV:

1. Remove the screws holding your TV to the stand.
2. Remove the stand from your TV.
3. Secure the wall mount bracket to the back of your TV using four screws. Follow the instructions of the user manual that came with the wall mount bracket to install.

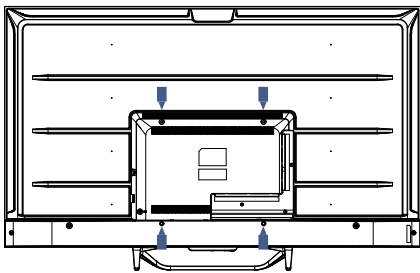

NOTE
The wall mount bracket are not included.

4. Fix the wall mount screws (M6x12mm/4pcs) into the rear side of the LEDTV ,using the torque of 12kgf.cm.

TURNING ON THE TV

1. Install the stand and place the TV on a solid surface.

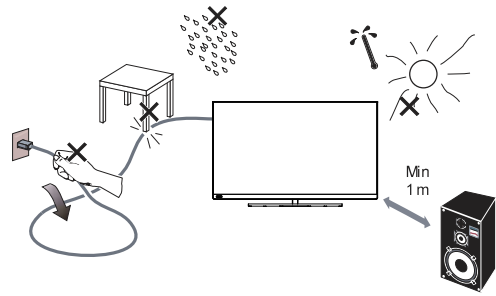

NOTE

- Ensure that the TV is placed in a position to allow free flow of air. Do not cover the ventilation openings on the back cover.
 - To prevent any unsafe situations, no naked flame sources, such as lighted candles, should be placed on or in the vicinity.
 - Avoid heat, direct sunlight and exposure to rain or water. The equipment shall not be exposed to dripping or splashing.
2. Connect the antenna cable or cable TV cable to the **ANT IN** aerial socket on the back of the TV set.
 3. Remote control:
Remove the cover of the battery compartment. Insert 2 batteries (Type AAA 1.5V).
CAUTION: Risk of fire explosion if the battery is replaced by an incorrect type.

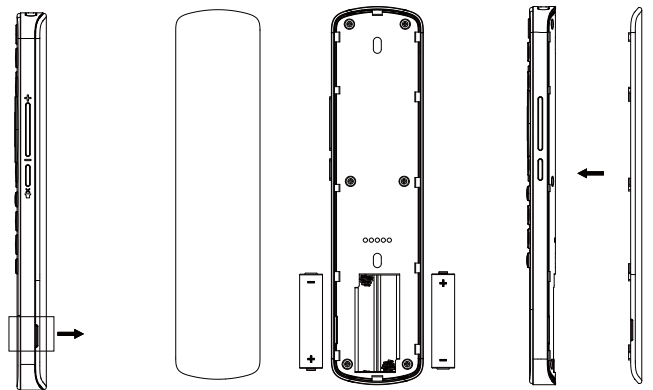

4. Power:
Plug the cord into a working power outlet.

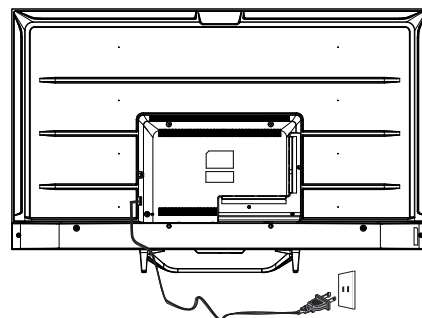

5. Turn the TV on:
Press **⏻** on the remote control or **POWER** button on the side control panel of the TV.

PERIPHERAL CONNECTION AND CONTROLS

BUTTON CONTROL

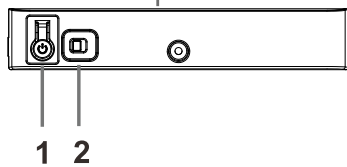
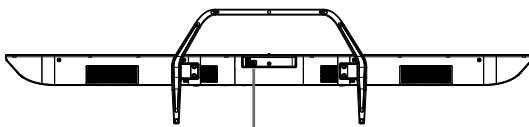
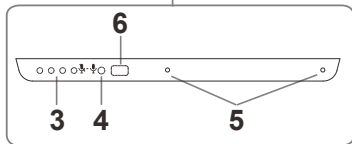
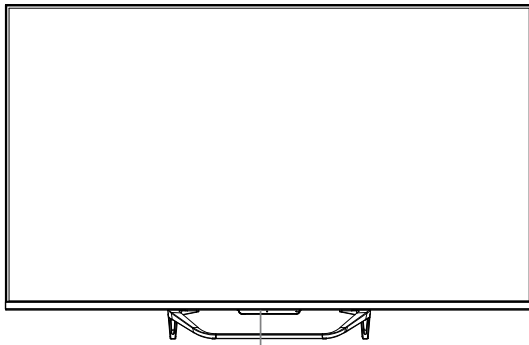

1. Power On / Power Off
2. Voice On / Voice Off
 - 🗣 Enable Far Field Assistant
 - 🗣 Disable Far Field Assistant

Turn it right to set it On , the indicator light will lighting and then go off, the voice function has been initiated. you can say "Ok Google" to use voice function, and the indicator will lighting when the TV receives the voice, then directly say your request.

Turn it left to set it Off to exit voice function, indicator light will go to yellow.

3. Far Field Assistant light
4. Remote control signal receiver
5. Voice signal receiver
6. Power LED

NOTE
 Make sure the TV is connected to the Internet before using Voice.
 Please set it to On before using Voice.
 Please log in to your GOOGLE account before using Voice.

ACCESSORIES

- Remote Control - 1pcs
- User's Manual - 1pcs
- Screws - 6 pcs
- Quick Start Guide - 1pcs
- Warranty Card - 1pcs

PERIPHERAL CONNECTION



All the terminals are(from left to right):
 LAN, OPTICAL, VIDEO, L, R, HDMI4, HDMI3, HDMI2,

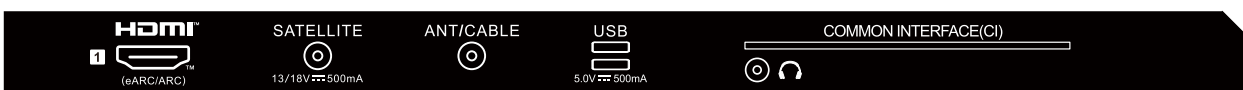

All the terminals are(from left to right):
 HDMI1(eARC/ARC), LNB IN (SATELLITE), ANT IN (ANTENNA/CABLE), USB1 , USB2 , EARPHONE, CI.

MAKING CONNECTIONS

AV EQUIPMENT

This TV provides one group of AV for convenient connection to VCR, DVD or other video equipment.

Please refer to the owner's manual of the equipment to be connected as well. You can use the input terminals on TV set rear as follows.

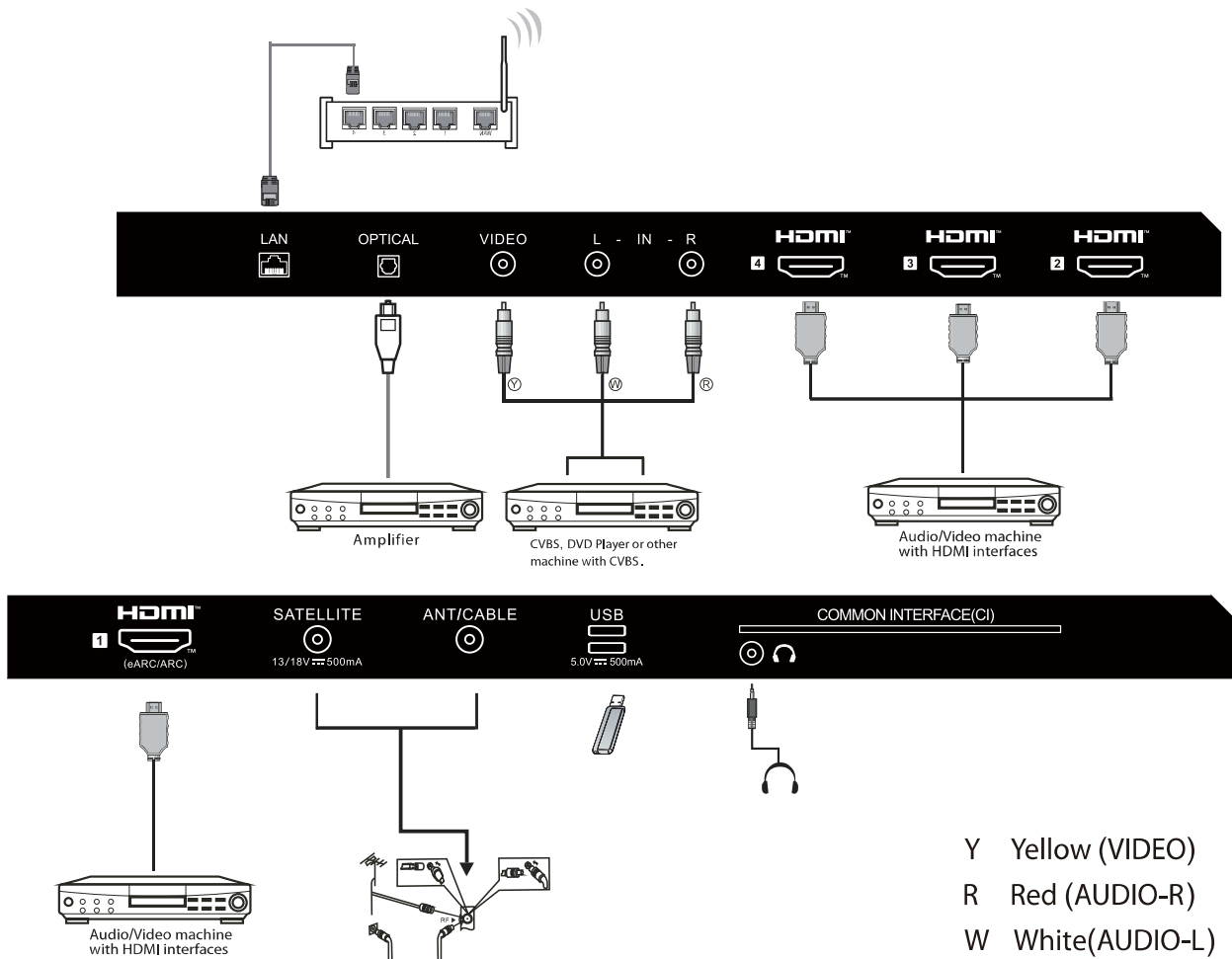

It can be connected to the following appliances: VCR, multi disc player, DVD, camcorder, video game or stereo system, etc.....

Note:

Sometimes it will not support in different device because the device supplies nonstandard signal.

OPERATING INSTRUCTIONS

USING THE REMOTE CONTROL



#	Item	Descriptions
1	Power	Press to turn the TV on or off. When your TV is off, power still flows through it. To completely disconnect power, unplug the power cord
2		Press to open MAGIC BOARD.
3		Press to open or close the on-screen menu.
4		Press to Accounts&Sign-in to Google TV. (When setting up basic TV, this key has no effect)
5		Press to navigate the on-screen menu.
6		Return to the previous menu.
7		Press to open the Home Page.
8		Press to change TV channels.
9		Press to prime vido for viewing onlineTV shows and flms (internet connection required).
10		Press to open the Live TV.
11		Press to open the YouTube Music.
12		Press to open the NETFLIX.
13	MEDIA	Press to open the Multi Media Player.
14		Press to open the Google Assistan or start voice search.
15		Press to open the settings menu.
16	VOL+/VOL-	Press VOL+ or VOL- to adjust volume level.
17	OK	Enter the selected option or perform the selected operation.
18		Press to mute and un-mute the sound.
19		Press to display electronic programme guide in TV mode.
20		Press to change TV channels.
21		Press to open the input source list.
22		Press to play/pause in multimedia mode.
23	AUDIO	Press to switch audio tracks.
24		Press to open the apps.
25		Press to open the YouTube.

OPERATING INSTRUCTIONS

INITIAL SETUP

The first time you turn on your TV, the setup wizard will guide you through setting up basic settings. Please according to the Text Tip to First Time Setup.

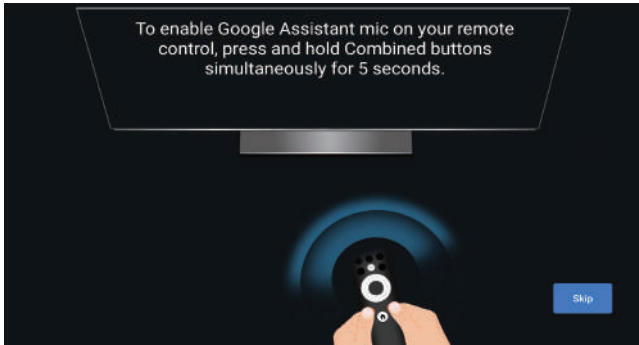

This function is used for the remote control pair code. After the code is successful, you can use the Bluetooth remote control to operate the TV.

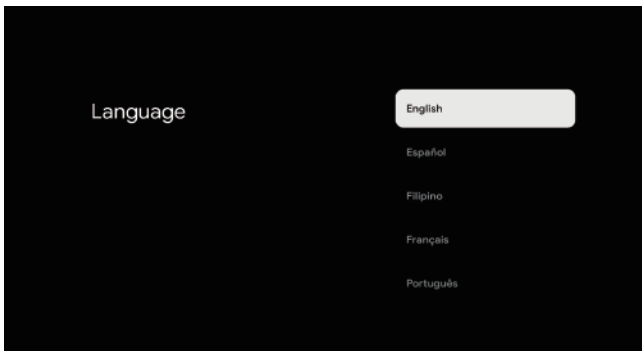

Press ▲/▼ to select the system language and press OK to confirm the language.

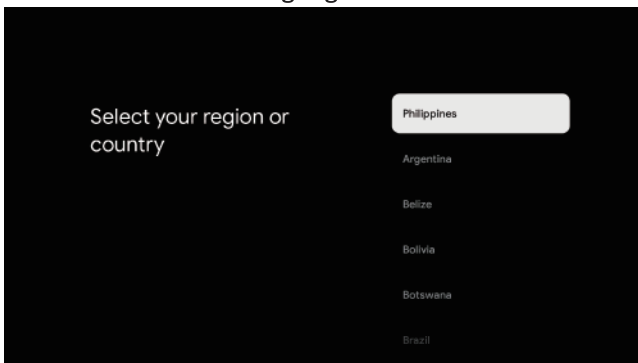

Press ▲/▼ to select the region/country of your device and press OK to confirm.

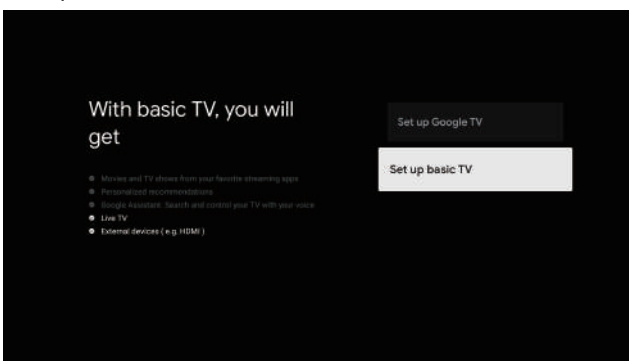

Press ▲/▼ to select the "Set up basic TV" of your device and press OK to complete the setup.

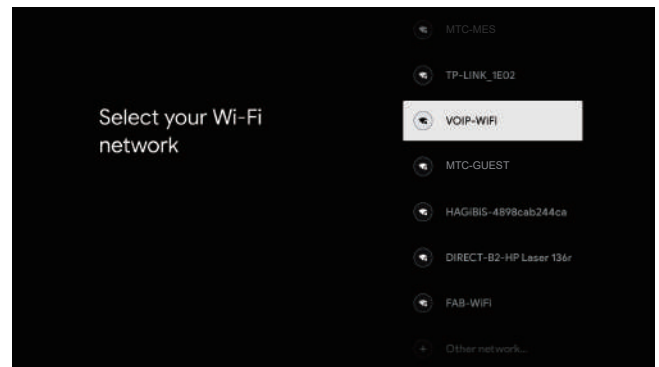

Press ▲/▼ to select the wifi to connect, press OK and enter the password to confirm the connection is successful.

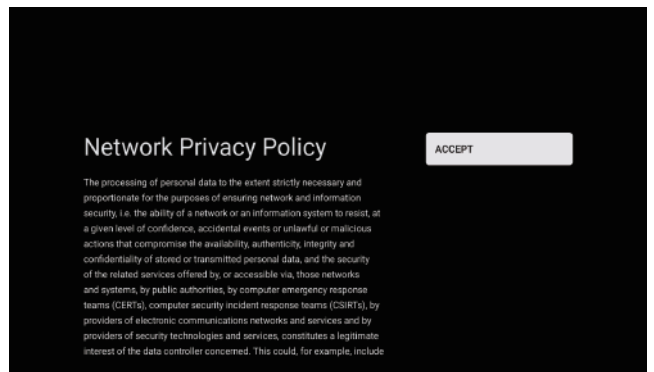

select "Accept" to accept this terms of the Network Privacy Policy.

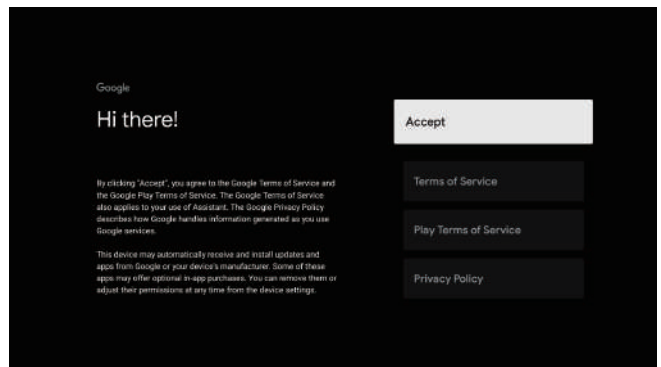

By accepting the Google Terms of Service to improve the product experience, select "Accept" to accept this condition.

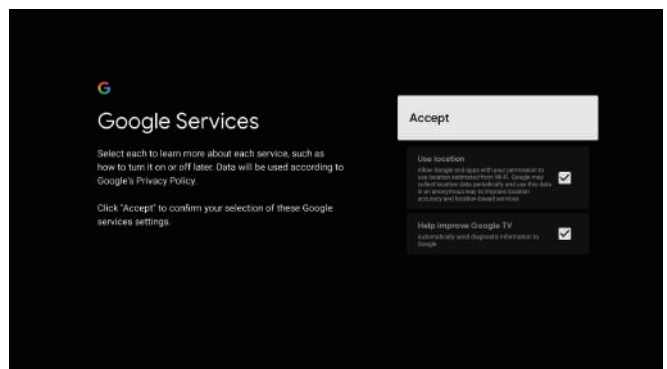

OPERATING INSTRUCTIONS

By accepting the Google Services to improve the product experience, select “Accept” to accept this condition.



Used to set your device's password to ensure security and privacy.

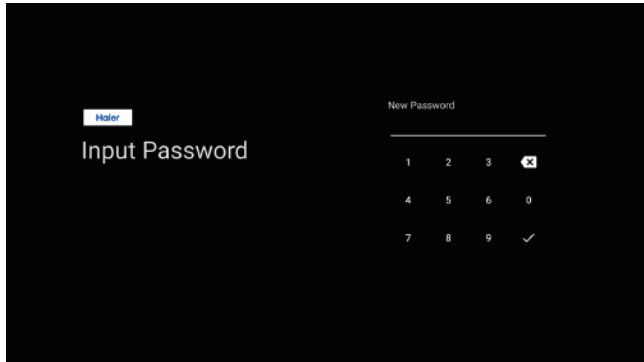

Use the remote control/soft keyboard to enter the 4-digit password auto-matically jump to the next interface.

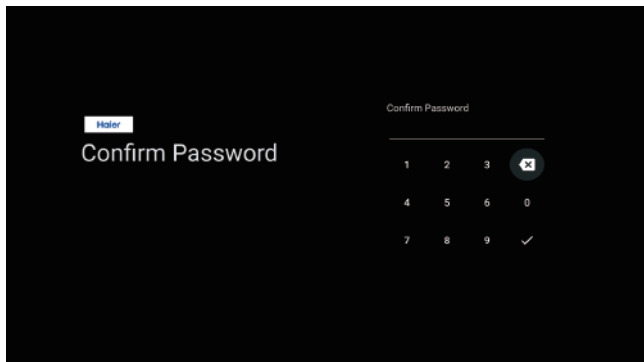

Confirm the password again and keep it consistent Use the remote control /soft keyboard to enter the password and complete the password.

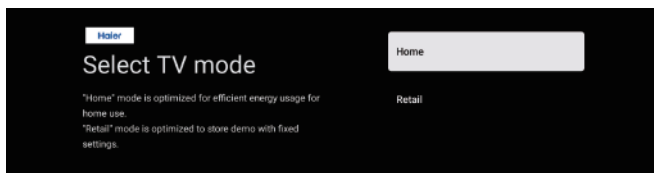

For selecting the mode, press ▲/▼ key to select Home mode and press **OK**.

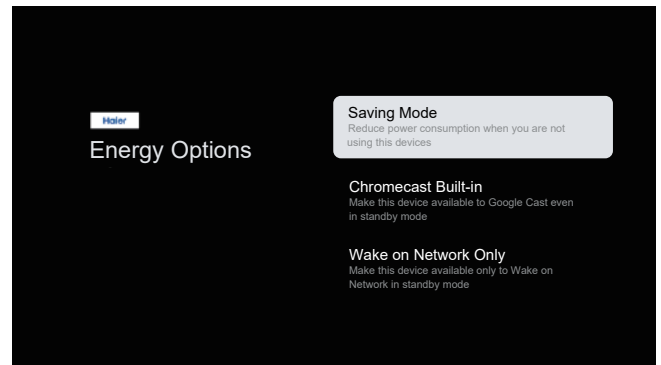

Select “Saving Mode” and proceed to the next step.

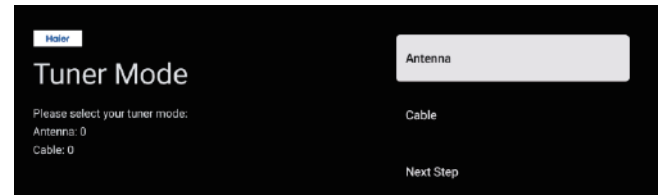

Select the Tuner mode for searching, press to select and press OK to confirm.

OPERATING INSTRUCTIONS

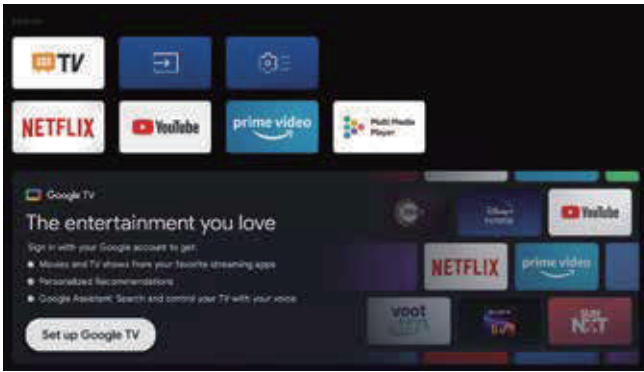

- Once in the user interface, you can switch from basic TV to Google TV settings.

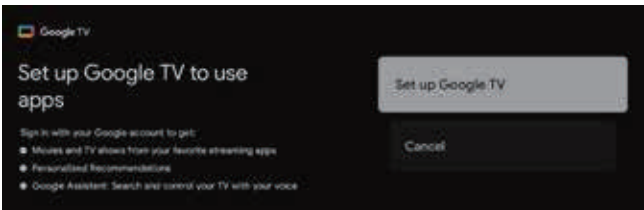

Press ▲/▼ to select the “Set up Google TV” of your device and press OK to complete the setup.

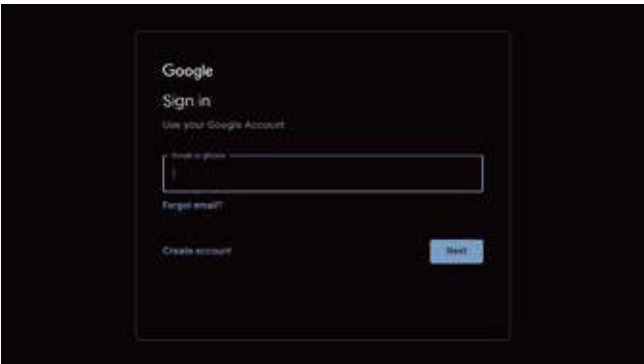

Use your Google Account Sign in

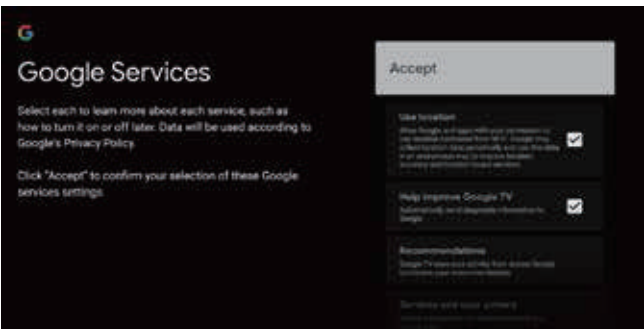
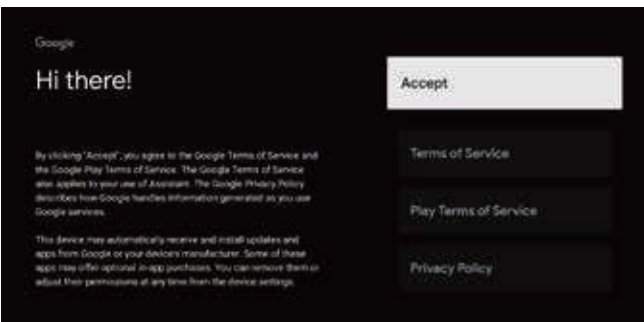

By accepting the Google Terms of Service to improve the product experience, select "Accept" to accept this condition.

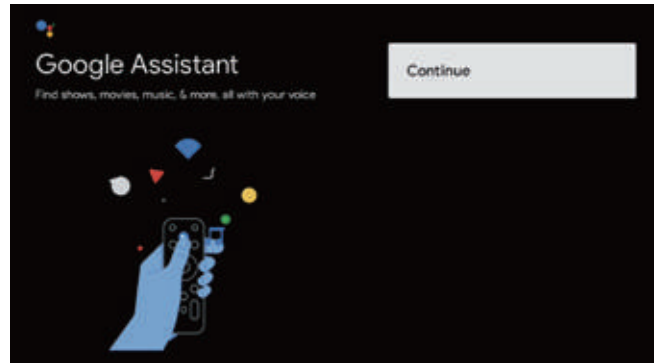

Press to select and press OK to continue.

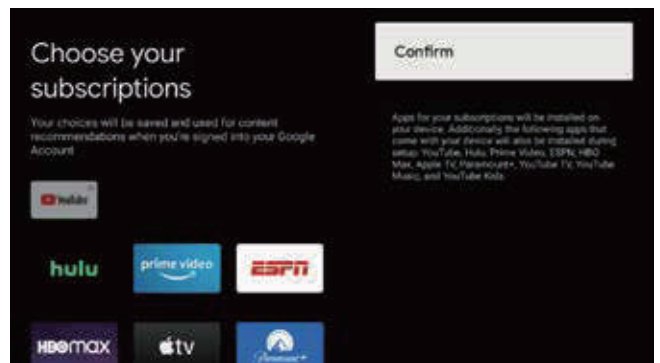

Press ▲/▼ to select the Choose your subscriptions and press OK .

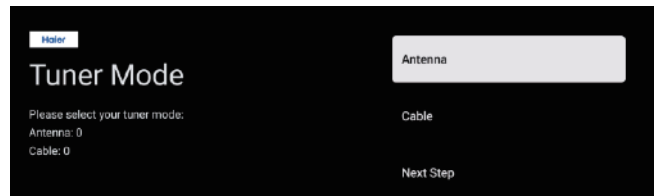

OPERATING INSTRUCTIONS

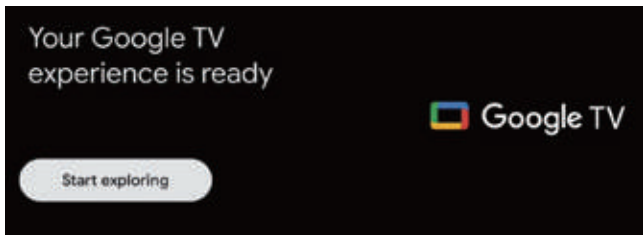

Your Google TV experience is ready and press OK to Start exploring.

HOME SCREEN

After completing the wizard Settings, you can watch TV and go to the home screen.

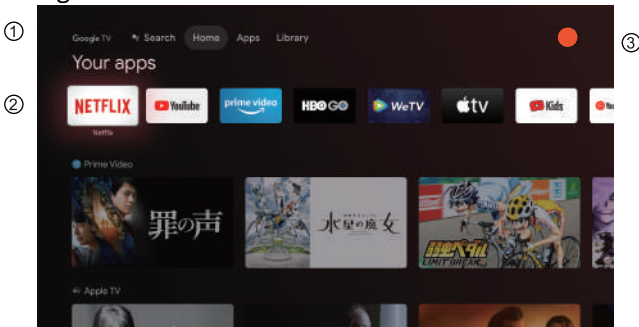

- ① **Search** Open the google assistant or start a voice search.
Home Open your TV homepage.
Apps Open the list of apps you've installed and add your favorite apps.
Library View the content purchased and leased under the user account.
- ② A list of applications you've installed and push content you've installed programs.
- ③ Open your account information, settings, time, inputs, and picture.
 - Settings**: Various settings can be configured here. For details on the settings, see the next explanation.
 - Inputs**: Icon to select an input source.
 - Picture**: The user can set the TV picture. See page 12 for detailed instructions on setup.

NAVIGATING THE ON-SCREEN MENU

There are two ways to enter. First, in live TV, press the menu button to display TV options, press ▲/▼ ◀/▶ to select the settings menu and press **OK** to confirm. Second, in the HOME interface, press the ▶ key to select the icon of the ⚙️ menu, press **OK** to confirm.

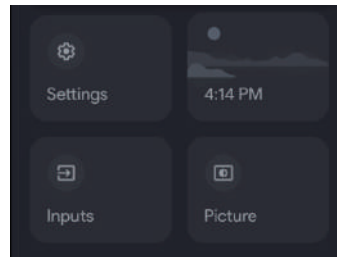
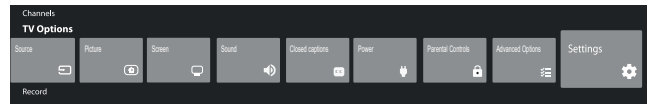

Press ▲/▼ button to select what you want set. Press **OK** to enter setting.

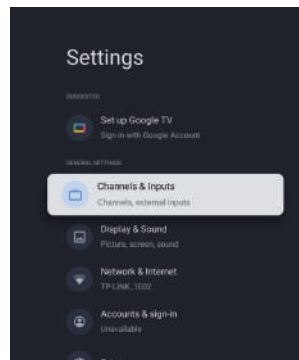

Press **BACK** to return to the previous menu. If the main menu is displayed, pressing **BACK** will close the onscreen menu.

OPERATING INSTRUCTIONS

CHANNELS

Menu->Settings->Channels & Inputs->Channels.

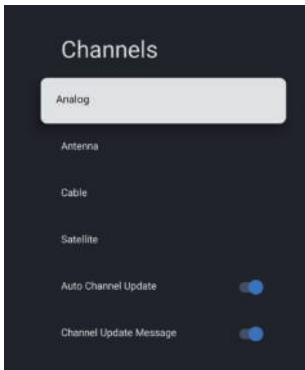

Analog/Antenna/Cable/Satellite - Press ▲/▼ button to select the option then press OK button to enter the sub-menu.

Auto Channel Update - Press OK button to choose **ON/OFF**. When selecting ON, the system will automatically scan and update channels after 5 minutes of standby.

Channel Update Message - Press OK button to choose **ON/OFF**. When selecting ON, the system will show you the update message.

Note:The available source might differ depending on the model.

INPUTS

Menu->Settings->Channels & Inputs-> Inputs

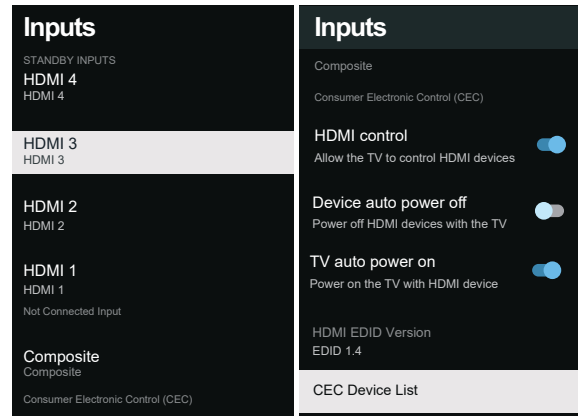

Inputs – Press ▲/▼ button to select the option then press OK button to enter the sub-menu.

HDMI control – Press ▲/▼ button to select the option then press OK button to choose ON/OFF.

Device auto power off – Press ▲/▼ button to select the option then press OK button to choose ON/OFF.

TV auto power on – Press ▲/▼ button to select the option then press OK button to choose ON/OFF.

HDMI EDID Version – show EDID version.

CEC Device List – Press ▲/▼ button to select the option then press OK button to enter the sub-menu.

DISPLAY & SOUND

Menu->Settings-> Display & Sound

In this menu, you can set picture, sound and audio output of TV.

1. Press ▲/▼ button to select what you want set .
2. Press OK button to confirm.
3. After finishing your adjustment, Press BACK button to return to the previous menu.

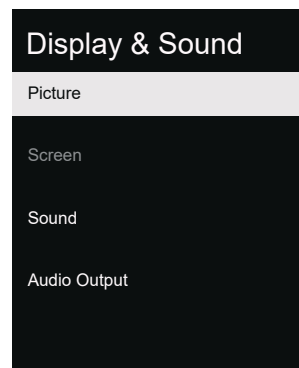

OPERATING INSTRUCTIONS

PICTURE

Menu->Settings->Display & Sound-> Picture.

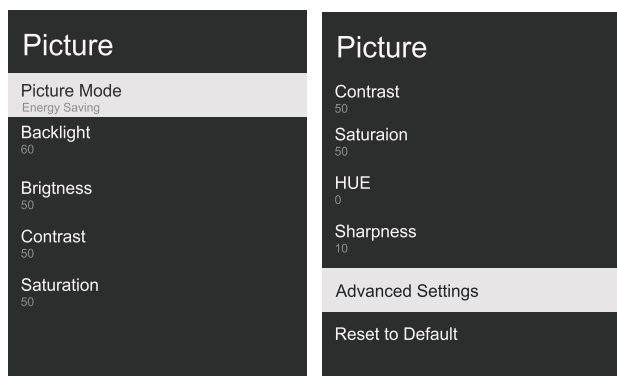

Picture Mode – Press ▲/▼ button to select the option then press **OK** button to enter the sub-menu. (Optional: user, Standard, Vivid, Sport, Movie, Game, Energy saving).

Backlight/Brightness/Contrast/Saturation/HUE/Sharpness – Press ▲/▼ button to select the option then press **OK** button to enter.

Press ◀ to decrease the parameter. Press ▶ to increase the parameter.

Advanced Settings – Press ▲/▼ button to select the option then press **OK** button to enter the sub-menu.

Reset to Default – Reset all settings to the factory defaults.

Balance/ Bass/ Treble – Press ▲/▼ button to select the option then press **OK** button to enter. Press ◀ to decrease the parameter. Press ▶ to increase the parameter.

dbx - tv – Press ▲/▼ button to select the option then press **OK** button to enter the sub-menu.

Surround Sound – Press ▲/▼ button to select the option then press **OK** button to choose ON/OFF.

Equalizer Detail – Press ▲/▼ button to select the option then press **OK** button to enter the sub-menu.

Speakers – Press ▲/▼ button to select the option then press **OK** button to choose ON/OFF.

Speaker Delay – Press ▲/▼ button to select the option then press **OK** button to enter. Press ◀ to decrease the parameter. Press ▶ to increase the parameter.

eARC – Press ▲/▼ button to select the option, then press **OK** button to choose Auto/OFF.

Auto Volume Control – Press ▲/▼ button to select the option then press **OK** button to choose ON/OFF.

Downmix Mode – Press ▲/▼ button to select the option then press **OK** button to enter the sub-menu. (Optional: Stereo, Surround).

Dialog Enhancer – Press ▲/▼ button to select the option then press **OK** button to enter the sub-menu. (Optional: Off, Low, Medium and High).

Reset to Default – Reset all settings to the factory defaults.

SOUND

Menu->Settings-> Display & Sound-> Sound.

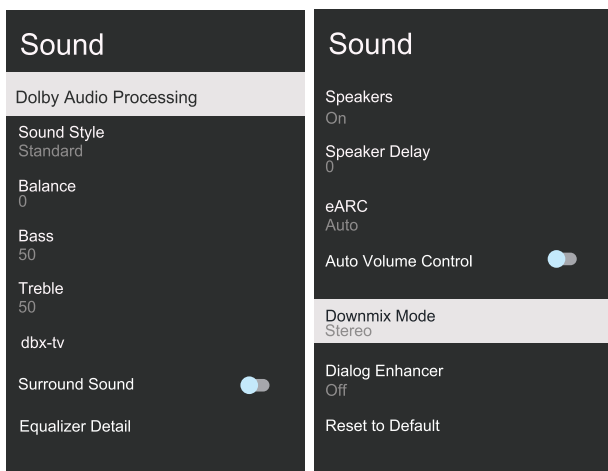

Dolby Audio processing – Press ▲/▼ button to select the option then press **OK** button to enter the sub-menu.

Sound style – Press ▲/▼ button to select the option then press **OK** button to enter the sub-menu. (Optional: user, Standard, Night, Sports, Movie, Music, News).

AUDIO OUTPUT

Menu->Settings->Display & Sound-> Audio Output.

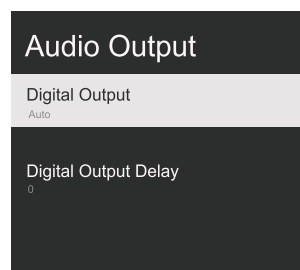

Digital Output – Press ▲/▼ button to select the option then press **OK** button to enter the sub-menu. (Optional: Auto, Bypass, PCM, Dolby Digital Plus and Dolby Audio-Dolby Digital).

Digital Output Delay – Press ▲/▼ button to select the option then press **OK** button to enter. Press ◀ to decrease the parameter. Press ▶ to increase the parameter.

OPERATING INSTRUCTIONS

NETWORK

Menu->Settings-> Network & Internet

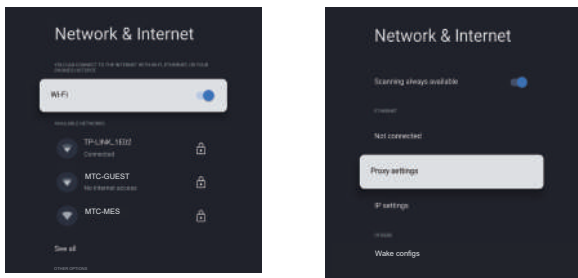

1. Press ▲/▼button to select what you want set .
2. Press OK button to confirm.
3. After finishing your adjustment, Press OK button save and return to the pervious menu.

ACCOUNTS & SIGN IN

1. Menu->Settings->Accounts & sign-in.
2. In the HOME interface, press the ▲/▼ button to Select "Set up Google TV" and proceed to the next step.

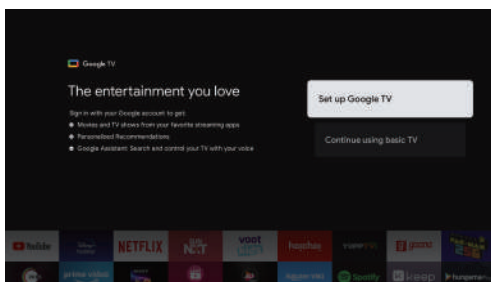

- Select "Set up Google TV" and proceed to the next step , enter your account and password.
And follow the prompts to complete the relevant settings.

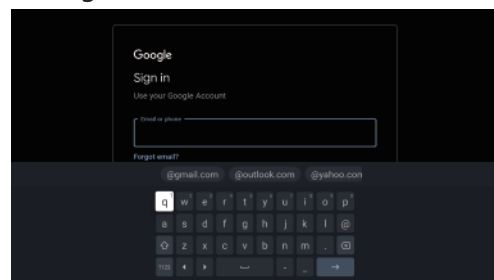

PRIVACY

Menu->Settings->Privacy.

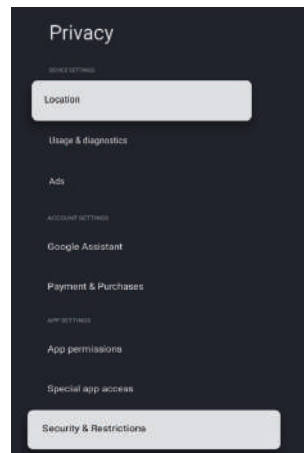

In this menu , you can set location, usage & diagnostics , etc of TV.

1. Press ▲/▼ button to select what you want set .
2. Press OK button to confirm.
3. After finishing your adjustment, Press BACK button to return to the previous menu.

LOCATION

Menu->Settings->Privacy ->Location.

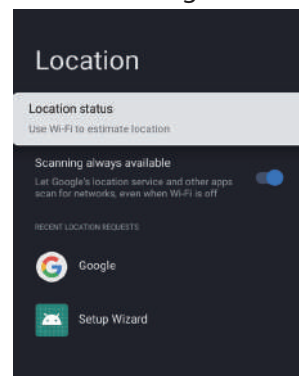

Location status – Press ▲/▼button to select the option then press OK button to enter the sub-menu.

(Optional: Use Wi-Fi to estimate location, Off)

Scanning always available – Press ▲/▼ button to select the option then press OK button to choose ON/OFF.

USAGE & DIAGNOSTICS

Menu->Settings->Privacy ->Usage & diagnostics.

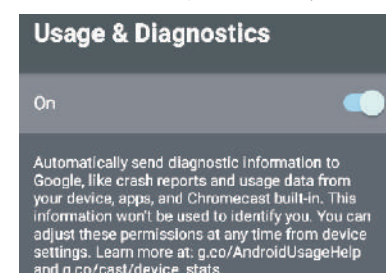

Usage & diagnostics – Press ▲/▼button to select the option then press OK button to choose ON/OFF.

OPERATING INSTRUCTIONS

APPS

Menu->Settings->Apps.

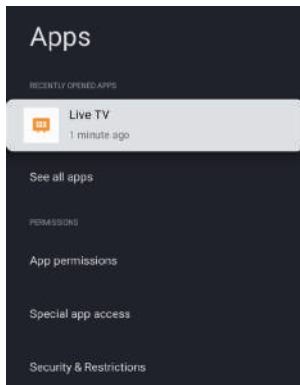

In this menu, you can set the APP permissions, and read the app lists

1. Press ▲/▼ button to select what you want set .
2. Press **OK** button to confirm.
3. After finishing your adjustment, press **BACK** button to return to the previous menu.

SYSTEM

Menu->Settings->System.

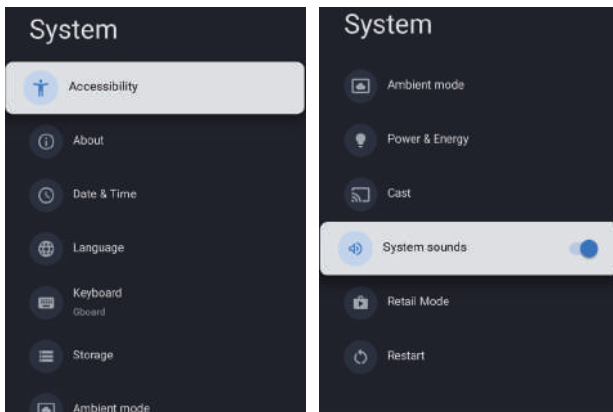

In this menu, you can read the information and settings of TV.

1. Press ▲/▼ button to select what you want set .
2. Press **OK** button to confirm.
3. After finishing your adjustment, Press **BACK** button to return to the previous menu.

System sounds – Press ▲/▼ button to select the option then press **OK** button to choose ON/OFF.

For details on the system ,see the next explanation.

ACCESSIBILITY

Menu->Settings->System -> Accessibility.

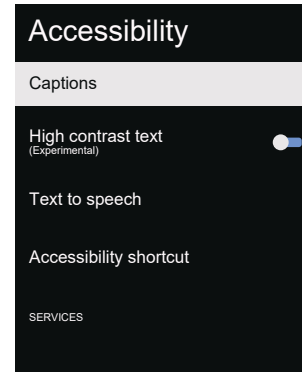

Captions – Press ▲/▼ button to select the option then press **OK** button to enter the sub-menu.

High contrast text – Press ▲/▼ button to select the option then press **OK** button to choose ON/OFF.

Text to speech – Press ▲/▼ button to select the option then press **OK** button to enter sub-menu.

Accessibility shortcut – Press ▲/▼ button to select the option then press **OK** button to enter sub-menu.

ABOUT

Menu->Settings->System ->About.

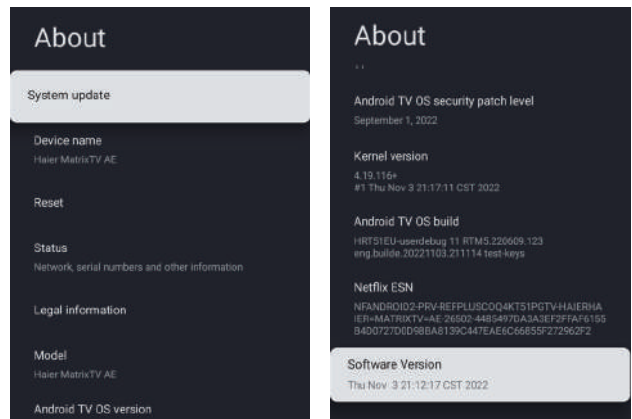

In this menu, you can System update, Reset and read the information of TV.

1. Press ▲/▼ button to select what you want
2. Press **OK** button to confirm.
3. After finishing your adjustment, Press **BACK** button to return to the previous menu.

DATE&TIME

Menu->Settings->System -> Date & Time.

OPERATING INSTRUCTIONS

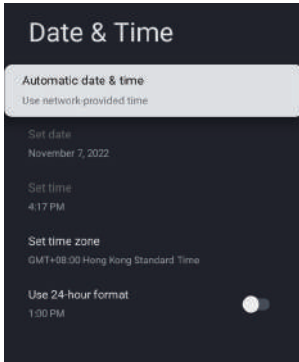

Automatic date & time – Press ▲/▼ button to select the option then press **OK** button to enter the sub-menu.

(Optional: Use network-provided time, Off)

NOTE

• When the Automatic date & time to OFF, you can use Manually adjusting date & time.

Set date – Press ▲/▼ button to select the option then press **OK** button to enter the sub-menu.

Set time – Press ▲/▼ button to select the option then press **OK** button to enter the sub-menu.

Set time zone – Press ▲/▼ button to select the option then press **OK** button to enter the sub-menu.

Use 24-hour format – Press ▲/▼ button to select the option then press **OK** button to choose ON/OFF.

LANGUAGE

Menu->Settings->System->Language.

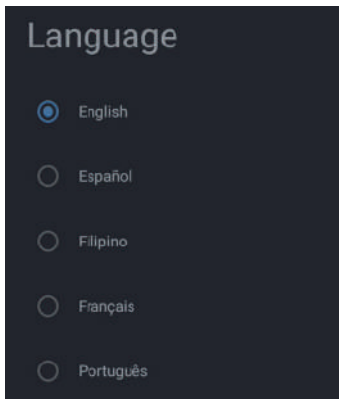

Language – Press ▲/▼ button to select the option then press **OK** button to enter the select language.

KEYBOARD

Menu->Settings->System->Keyboard.

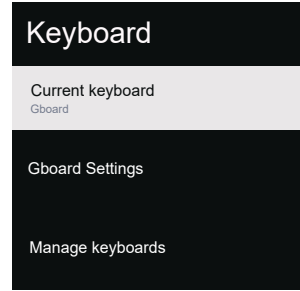

Current keyboard – Press ▲/▼ button to select the option then press **OK** button to enter the sub-menu.

Gboard Settings – Press ▲/▼ button to select the option then press **OK** button to enter the sub-menu.

Manage keyboards – Press ▲/▼ button to select the option then press **OK** button to enter the sub-menu.

STORAGE

Menu->Settings->System->Storage.

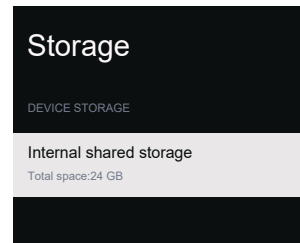

Internal shared storage – Press ▲/▼ button to select the option then press **OK** button to enter the sub-menu.

AMBIENT MODE

Menu->Settings->System-> Ambient mode.

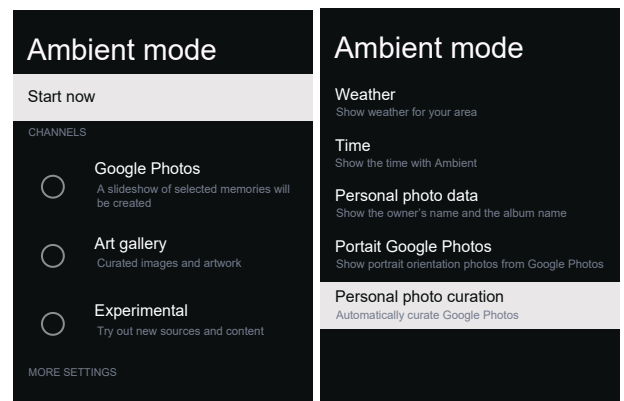

In this menu, you can set the ambient mode.

1. Press ▲/▼ button to select what you want set .
2. Press **OK** button to confirm.
- 3.After finishing your adjustment, Press **BACK** button to return to the previous menu.

OPERATING INSTRUCTIONS

POWER & ENERGY

Menu->Settings->System->Power & Energy.

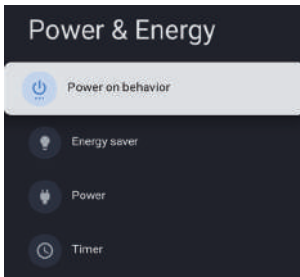

In this menu, you can set the power & energy. (power on behavior, energy saver, power and timer)

1. Press ▲/▼ button to select what you want set .
2. Press **OK** button to confirm.
3. After finishing your adjustment, Press **BACK** button to return to the previous menu.

POWER ON BEHAVIOR

Menu->Settings->System->Power & Energy
->Power on behavior.

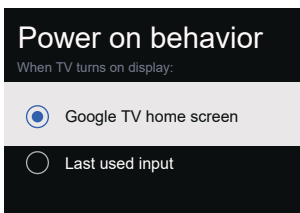

Press ▲/▼ button to select the option then press **OK** button to confirm.

ENERGY SAVER

Menu->Settings->System-> Power & Energy
->Energy saver.

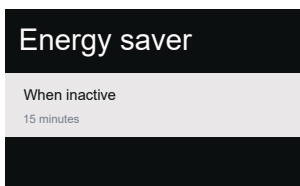

When inactive – Press ▲/▼ button to select the option then press **OK** button to enter the sub-menu.
(Optional:15 minutes,20 minutes,30 minutes, 1 hour,4 hours, 8hours, 12 hours , 24 hours , Never).

POWER

Menu->Settings->System-> Power & Energy
->Power.

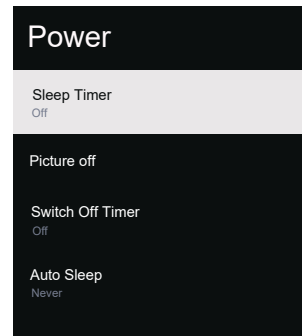

Sleep Timer – Press ▲/▼ button to select the option then press **OK** button to enter the sub-menu.

(Optional:off,10 minutes,20 minutes,30 minutes, 40 minutes,50 minutes, 60 minutes, 90 minutes, 120 minutes)

Picture off– Press ▲/▼ button to select the option then press **OK** button to confirm.

Switch off timer– Press ▲/▼ button to select the option then press **OK** button to enter the sub-menu.

(Optional:off,30 minutes,60 minutes,90 minutes, 120 minutes,150 minutes, 180 minutes, 210 minutes, 240 minutes)

Auto Sleep– Press ▲/▼ button to select the option then press **OK** button to enter the sub-menu.

(Optional:Never,4 hours,6 hours 8 hours)

TIMER

Menu->Settings->System->Power & Energy
->Timer.

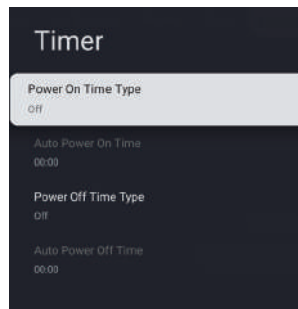

Power On Time Type – Press ▲/▼ button to select the option then press **OK** button to choose OFF / ON / ONCE.

Auto Power On Time – Press ▲/▼ button to select the option then press **OK** button to enter the sub-menu.

Power Off Time Type – Press ▲/▼ button to select the option then press **OK** button to choose OFF / ON / ONCE.

Auto Power Off Time – Press ▲/▼ button to select the option then press **OK** button to enter the sub-menu.

OPERATING INSTRUCTIONS

CAST

Menu->Settings->System->Cast.

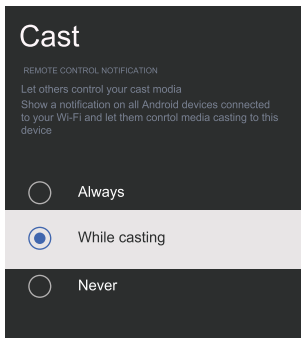

1. Press ▲/▼ button to select what you want set .
2. Press OK button to confirm.
3. Press BACK button to return to the previous menu.

RETAIL MODE

Menu->Settings->System->Retail Mode.

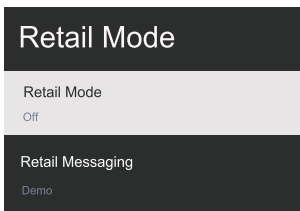

Retail mode – Press ▲/▼button to select the option then press OK button to choose ON/OFF.

Retail messaging – Press▲/▼button to select the option then press OK button to enter the sub-menu.(Note: Demo,e-POP,e-POP + Demo)

RESTART

Menu->Settings->System->Restart.

Press OK button to enter the sub-menu.
(Optional: restart and cancel)

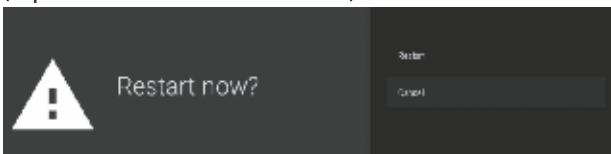

REMOTES & ACCESSORIES

Menu->Settings->Remotes & Accessories.

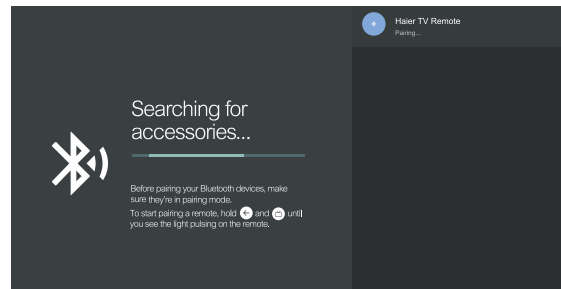
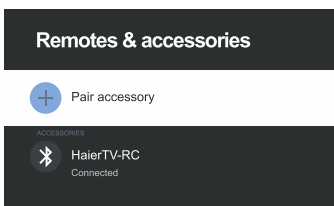

- In this menu,you can pair Bluetooth devices.
- 1.Press the " ← " and " ⏻ " buttons at the bottom of the remote control for 5 seconds.
 - 2.When the LED starts to flash, release it. The remote controller will send the pairing signal to the TV and display the information of the remote control on the right side of the screen.
 - 3.Press the OK button to display the pairing. If the paired is displayed, the connection is successful.
 - 4.If the couldn't pair appears, the connection fails. Wait 30 seconds and then press the " ← " and " ⏻ " buttons at the bottom of the remote control for 5 seconds to repeat the previous steps.
 - 5.Press " ← " button return to the previous menu.

USE OF MULTI MEDIA PLAYER

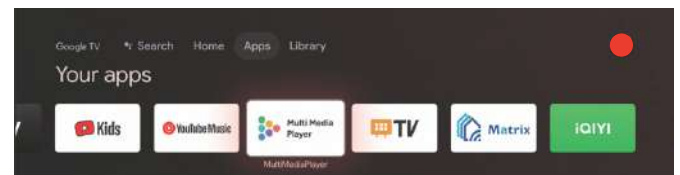

1. In the HOME or APPS interface, press ▲/▼◀/▶ to select the MultiMediaPlayer application

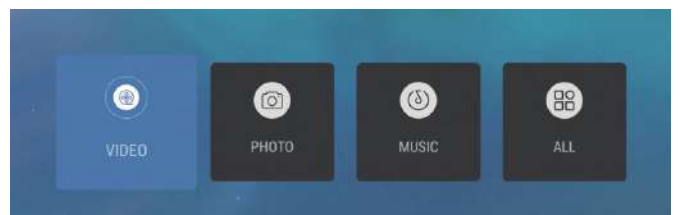

2. Select OK key to enter Multi Media Player and display Video, Photo, Audio. After inserting the usb flash drive, you can view the corresponding files in the usb flash drive (FAT32 Format).

NOTE

The menu may be different depending on when you purchased the TV.

TROUBLESHOOTING

Please make these simple checks before calling service. These tips may save you time and money since charges for receiver installation and adjustments of customer controls are not covered under your warranty.

Symptoms	Items to Check and Actions to Follow
"Ghost" or double image	<ul style="list-style-type: none"> This may be caused by obstruction to the antenna due to high rise buildings or hills. Using a highly directional antenna may improve the picture.
No power	<ul style="list-style-type: none"> Check if the TV's AC power cord is plugged into the outlet. Unplug the TV, wait for 60 seconds. Then reinsert plug into the outlet and turn on the TV again.
No picture	<ul style="list-style-type: none"> Check antenna connections at the rear of the TV to see if it is properly connected to the TV. Possible broadcast station trouble. Try another channel. Adjust the contrast and brightness settings. Check the Closed Captions control. Some TEXT modes could block the screen.
Good picture but no sound	<ul style="list-style-type: none"> Press the MUTE button on the remote control to ensure mute is off.
Good sound but poor color	<ul style="list-style-type: none"> Adjust the contrast, color and brightness settings.
Poor picture	<ul style="list-style-type: none"> Poor picture quality may occur when an activated S-VHS camera or camcorder is connected to your TV and other peripherals at the same time. Switch off one of the peripherals.
Snowy picture and noise	<ul style="list-style-type: none"> Check the antenna connection.
Horizontal dotted line	<ul style="list-style-type: none"> This may be caused by electrical interference (e.g. hair dryer, nearby neon lights, etc.) Turn off the equipment.
Television not responding to remote control	<ul style="list-style-type: none"> Check whether the batteries are working. Replace if necessary. Clean the remote control sensor lens on the TV.
Pixels (dots) that are always dark or always lit	<ul style="list-style-type: none"> Your TV is precision-manufactured using an extremely high level of technology. However, sometimes pixels may not display correctly. These types of occurrences are inherent to this type of product and do not constitute a defective product.

NOTE

• This product uses a panel consisting of sub pixels which require sophisticated technology to produce. However, there may be a few bright or dark pixels on the screen. These pixels will have no impact on the performance of the product.



The terms HDMI, HDMI High-Definition Multimedia Interface, HDMI Trade dress and the HDMI Logos are trademarks or registered trademarks of HDMI Licensing Administrator, Inc.



Dolby, Dolby Vision, Dolby Atmos, Dolby Audio and the double-D symbol are trademarks of Dolby Laboratories Licensing Corporation. Manufactured under license from Dolby Laboratories. Confidential unpublished works. Copyright ©2012-2024 Dolby Laboratories. All rights reserved.

PRODUCT SPECIFICATION

43" UHD LED TV

Television picture quality:	UHD Integrated digital. Screen Size: 108 cm Resolution 3840x2160 pixels 60Hz.
TV System:	PAL-B/G,SECAM-B/G
DTV Tuner Decoder	DVB-T, DVB-C, DVB-T2, DVB-S2 16/32/64/128/256 QAM modulation MPEG2,MPEG4,H.265
Connectivity:	1 Optical port 2 USB ports 1 LAN 4 HDMI sockets 1 VIDEO socket 1 L socket 1 R socket 2 RF sockets 1 EARPHONE port 1 CI slot Supported Systems:PAL+SECAM Storage channel number: 1000(DTV),100(ATV) TV (RF) :75 Ω Imbalance AV Video-Input:75 Ω ,1V-P,RCA AV Audio-Input:20K Ω ,500mV RMS HDMI Video Input: 480i, 480p, 720p, 1080i, 1080p,2160p WiFi : Standard: IEEE 802.11a/b/g/n/ac ,Frequency: 2.4GHz/5GHz Bluetooth:V5.1
Sound quality:	Stereo sound system. 2 x 10 watts RMS power output.
Standby Power consumption	≤0.5W
Digital features:	Digitally interactive. Digital text. Digital video broadcasting (DVB) subtitles available. Auto setup. Auto scan for new channels. Now and next programme guide. 7 day electronic programme guide (EPG). CI slot. Audio description compatible.
Additional features:	UHF/VHF tuner;Sleep timer;Parental Guidance;Picture and text Remote control batteries required 2 x AAA . VESA Mount Size: 300x300mm Package Size (WxHxD): 1075x652x142 mm Set Size (WxHxD) with Stand: 957.2x607.4x240.7 mm Set Size (WxHxD) without Stand: 957.2x566.7x86.6 mm Package weight : 10 kg Set weight with stand: 7.2kg Set weight without stand: 6.8kg

* The part specifications of this TV set provided here are for reference only.
Diferences may occur as product technology is updated.
Design and specifications are subject to change without notice.

PRODUCT SPECIFICATION

50 "UHD LED TV

Television picture quality:	UHD Integrated digital. Screen Size: 126 cm Resolution 3840x2160 pixels 60Hz.
TV System:	PAL-B/G,SECAM-B/G
DTV Tuner Decoder	DVB-T, DVB-C, DVB-T2, DVB-S2 16/32/64/128/256 QAM modulation MPEG2,MPEG4,H.265
Connectivity:	1 Optical port 2 USB ports 1 LAN 4 HDMI sockets 1 VIDEO socket 1 L socket 1 R socket 2 RF sockets 1 EARPHONE port 1 CI slot Supported Systems:PAL+SECAM Storage channel number: 1000(DTV),100(ATV) TV (RF) :75 Ω Imbalance AV Video-Input:75 Ω ,1V-P,RCA AV Audio-Input:20K Ω ,500mV RMS HDMI Video Input: 480i, 480p, 720p, 1080i, 1080p,2160p WiFi : Standard: IEEE 802.11a/b/g/n/ac ,Frequency: 2.4GHz/5GHz Bluetooth:V5.1
Sound quality:	Stereo sound system. 2 x 13.5 watts RMS power output.
Standby Power consumption	≤0.5W
Digital features:	Digitally interactive. Digital text. Digital video broadcasting (DVB) subtitles available. Auto setup. Auto scan for new channels. Now and next programme guide. 7 day electronic programme guide (EPG). CI slot. Audio description compatible.
Additional features:	UHF/VHF tuner;Sleep timer;Parental Guidance;Picture and text Remote control batteries required 2 x AAA. VESA Mount Size: 300x300mm Package Size (WxHxD): 1250x760x144 mm Set Size (WxHxD) with Stand: 1111.2x710.5x277.2 mm Set Size (WxHxD) without Stand: 1111.2x651.8x88 mm Package weight : 13.5kg Set weight with stand: 10kg Set weight without stand: 9.5kg

* The part specifications of this TV set provided here are for reference only.
Differences may occur as product technology is updated.
Design and specifications are subject to change without notice.

PRODUCT SPECIFICATION

55" UHD LED TV

Television picture quality:	UHD Integrated digital. Screen Size: 139 cm Resolution 3840x2160 pixels 60Hz.
TV System:	PAL-B/G,SECAM-B/G
DTV Tuner Decoder	DVB-T, DVB-C, DVB-T2, DVB-S2 16/32/64/128/256 QAM modulation MPEG2,MPEG4,H.265
Connectivity:	1 Optical port 2 USB ports 1 LAN 4 HDMI sockets 1 VIDEO socket 1 L socket 1 R socket 2 RF sockets 1 EARPHONE port 1 CI slot Supported Systems:PAL+SECAM Storage channel number: 1000(DTV),100(ATV) TV (RF) :75 Ω Imbalance AV Video-Input:75 Ω ,1V-P,RCA AV Audio-Input:20K Ω ,500mV RMS HDMI Video Input: 480i, 480p, 720p, 1080i, 1080p,2160p WiFi : Standard: IEEE 802.11a/b/g/n/ac ,Frequency: 2.4GHz/5GHz Bluetooth:V5.1
Sound quality:	Stereo sound system. 2 x 13.5 watts RMS power output.
Standby Power consumption	≤0.5W
Digital features:	Digitally interactive. Digital text. Digital video broadcasting (DVB) subtitles available. Auto setup. Auto scan for new channels. Now and next programme guide. 7 day electronic programme guide (EPG). CI slot. Audio description compatible.
Additional features:	UHF/VHF tuner;Sleep timer;Parental Guidance;Picture and text Remote control batteries required 2 x AAA . VESA Mount Size: 300x300mm Package Size (WxHxD): 1350x837x144mm Set Size (WxHxD) with Stand: 1225.8x777.3x277.2mm Set Size (WxHxD) without Stand: 1225.8x719.4x88.1mm Package weight :16.4 kg Set weight with stand: 11.9 kg Set weight without stand: 11.4 kg

* The part specifications of this TV set provided here are for reference only.
Differences may occur as product technology is updated.
Design and specifications are subject to change without notice.

PRODUCT SPECIFICATION

65" UHD LED TV

Television picture quality:	UHD Integrated digital. Screen Size: 164cm Resolution 3840x2160 pixels 60Hz.
TV System:	PAL-B/G,SECAM-B/G
DTV Tuner Decoder	DVB-T, DVB-C, DVB-T2, DVB-S2 16/32/64/128/256 QAM modulation MPEG2,MPEG4,H.265
Connectivity:	1 Optical port 2 USB ports 1 LAN 4 HDMI sockets 1 VIDEO socket 1 L socket 1 R socket 2 RF sockets 1 EARPHONE port 1 CI slot Supported Systems:PAL+SECAM Storage channel number: 1000(DTV),100(ATV) TV (RF) :75 Ω Imbalance AV Video-Input:75 Ω ,1V-P,RCA AV Audio-Input:20K Ω ,500mV RMS HDMI Video Input: 480i, 480p, 720p, 1080i, 1080p,2160p WiFi : Standard: IEEE 802.11a/b/g/n/ac ,Frequency: 2.4GHz/5GHz Bluetooth:V5.1
Sound quality:	Stereo sound system. 2 x 13.5 watts RMS power output.
Standby Power consumption	$\leq 0.5W$
Digital features:	Digitally interactive. Digital text. Digital video broadcasting (DVB) subtitles available. Auto setup. Auto scan for new channels. Now and next programme guide. 7 day electronic programme guide (EPG). CI slot. Audio description compatible.
Additional features:	UHF/VHF tuner;Sleep timer;Parental Guidance;Picture and text Remote control batteries required 2 x AAA. VESA Mount Size: 400x300mm Package Size (WxHxD): 1600x960x164mm Set Size (WxHxD) with Stand: 1446.4x904.7x313.8mm Set Size (WxHxD) without Stand: 1446.4x841.3x85.1mm Package weight : 24 kg Set weight with stand: 17.2 kg Set weight without stand: 16.5 kg

* The part specifications of this TV set provided here are for reference only.
Differences may occur as product technology is updated.
Design and specifications are subject to change without notice.

Haier

Haier

Живот с вдъхновение

Ръководство
за употреба

МОДЕЛИ:

H43Q80FUX

H50Q80FUX

H55Q80FUX

H65Q80FUX



Илюстрациите в това ръководство са дадени само за справка и може да се различават от реалния продукт.

Дизайнът и спецификациите на продукта могат да бъдат променяни без предизвестие.

LED телевизор

СЪДЪРЖАНИЕ

1. ВАЖНИ ИНСТРУКЦИИ ЗА БЕЗОПАСНОСТ	1
2. ПОДГОТОВКА	3
3. СВЪРЗВАНЕ И УПРАВЛЕНИЕ НА ПЕРИФЕРНИ УСТРОЙСТВА.....	4
4. СВЪРЗВАНЕ.....	5
5. ИНСТРУКЦИИ ЗА РАБОТА.....	6
6. ОТСТРАНЯВАНЕ НА НЕИЗПРАВНОСТИ.....	19
7. СПЕЦИФИКАЦИИ НА ПРОДУКТА	20





Илюстрациите в това ръководство са дадени само за справка и може да се различават от реалния продукт.

Дизайнът и спецификациите на продукта могат да бъдат променени без предизвестие.

ВАЖНИ ИНСТРУКЦИИ ЗА БЕЗОПАСНОСТ

- 1) Прочетете тези инструкции.
- 2) Запазете тези инструкции.
- 3) Спазвайте всички предупреждения.
- 4) Следвайте всички инструкции.
- 5) Не използвайте този уред в близост до вода.
- 6) Почиствайте само със суха кърпа.
- 7) Не блокирайте вентилационните отвори, монтирайте в съответствие с инструкциите.
- 8) Не инсталирайте в близост до източници на топлина, като радиатори, решетки на отоплителна система, готварски печки и други уреди (включително усилватели), които генерират топлина.
- 9) Не нарушавайте защитната функция на поляризирания щепсел. Ако доставеният с продукта щепсел не съответства на Вашия контакт, се обърнете към електротехник, който да смени контакта.
- 10) Пазете захранващия кабел – не стъпвайте върху него и не го огъвайте прекалено, особено в близост до щепсела, розетката и при изхода му от уреда.
- 11) Използвайте само приставки/аксесоари, посочени от производителя.
- 12) Изключвайте уреда от контакта по време на гръмотевична буря или когато не се използва за дълги периоди от време.
- 13) За сервизно обслужване се обърнете към квалифициран сервизен техник. Обслужване се налага, когато уредът има някаква повреда, като например повреден захранващ кабел или щепсел, върху уреда е разлята течност или в него са попаднали чужди тела, излаган е на дъжд или влага, не работи нормално или е паднал.
- 14) Щепселът се използва за изключване на устройството, той трябва да бъде лесно достъпен.
- 15) Вентилацията не трябва да се възпрепятства чрез покриване на вентилационните отвори с предмети, като вестници, покривки за маса, завеси и др.
- 16) Върху уреда не трябва да се поставят източници на открит пламък, като например свещи.
- 17) Обърнете внимание на екологичните аспекти при изхвърляне на батерията.
- 18) Уредът е предназначен за употреба в умерен климат.
- 19) Уредът не трябва да се излага на капки или пръски вода, и върху него не трябва да се поставят предмети, пълни с течност, като например вази.
- 20) Предупреждение: За да избегнете наранявания поради преобръщане на уреда, винаги го поставяйте стабилно върху хоризонталната повърхност на масата.

Когато щепселът не използва за изключване на устройството в инструкциите е указано, че трябва да бъде осигурен лесен достъп до контакта.

	ВНИМАНИЕ РИСК ОТ ТОКОВ УДАР НЕ ОТВАРЯЙТЕ!	
ВНИМАНИЕ ЗА ДА НАМАЛИТЕ РИСКА ОТ ТОКОВ УДАР, НЕ СВАЛЯЙТЕ КАПАКА (ИЛИ ЗАДНИЯ ПАНЕЛ). В ПРОДУКТА НЯМА ЧАСТИ, КОИТО ДА СЕ ОБСЛУЖВАТ ОТ ПОТРЕБИТЕЛЯ. ЗА СЕРВИЗНО ОБСЛУЖВАНЕ СЕ ОБРЪЩАЙТЕ КЪМ КВАЛИФИЦИРАНИ СЕРВИЗНИ ТЕХНИЦИ.		



Символът показва, че в уреда има опасно напрежение, което може да предизвика токов удар.



Символът показва, че в документацията на уреда има важни инструкции за работа и поддръжка.

ПРЕДУПРЕЖДЕНИЕ:

За да намалите риска от токов удар, не излагайте уреда на дъжд или влага.

ПРЕДУПРЕЖДЕНИЕ:

Не излагайте батериите на интензивна топлина, като слънчева светлина, огън и др.



Този символ означава, че продуктът има двойна изолация между опасното напрежение в електрическата мрежа и частите, достъпни за потребителя. Когато обслужвате продукта, използвайте само идентични резервни части.



Тази маркировка означава, че продуктът не трябва да се изхвърля заедно с битовите отпадъци. За да предотвратите евентуално замърсяване на околната среда или рискове за здравето в резултат от неконтролирано изхвърляне на отпадъци, рециклирайте продукта отговорно, за да спомогнете за устойчивата повторна употреба на суровините. Върнете употребявания уред чрез системата за предаване и събиране на вторични суровини или се свържете с търговеца, от когото сте закупили продукта. Той може да приеме продукта за екологосъобразно рециклиране.

* Реалният продукт може да се различава от горното изображение*

ВАЖНИ ИНСТРУКЦИИ ЗА БЕЗОПАСНОСТ

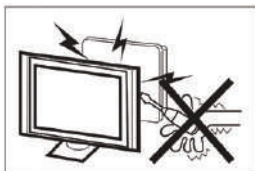

Този телевизионен приемник работи с високо напрежение. Не премахвайте задния капак на телевизора. За сервизно обслужване се обръщайте към квалифицирани сервизни техници.

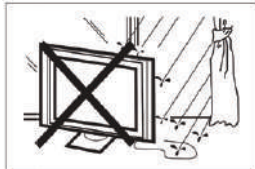

За да предотвратите опасност от пожар или токов удар, не излагайте телевизора на дъжд или влага.



Не пускайте и не пхайте предмети в процепите и отворите на корпуса на телевизора. Никога не разливайте течности върху телевизора.



Не блокирайте вентилационните отвори на задния капак. Правилната вентилация е от основно значение за предотвратяване на повреди в електрическите компоненти.



Не поставяйте телевизора върху захранващия кабел.



Когато почиствате телевизора, първо го изключете от контакта, използвайте мека кърпа и не използвайте вода и препарати.



Никога не стъпвайте, не се облягайте и не бутайте рязко телевизора или стойката. Обръщайте специално внимание на децата. Ако телевизорът падне, може да причини сериозни наранявания.

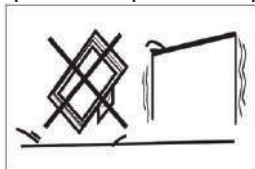

Не поставяйте телевизора на нестабилна количка, стойка, полица или маса. Ако телевизорът падне, може да причини сериозни наранявания и да се повреди.

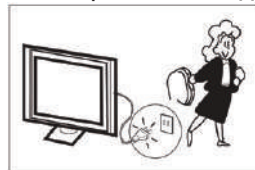

Ако не възнамерявате да използвате телевизора за дълъг период от време, препоръчваме да изключете щепсела от контакта.



Избягвайте да излагате телевизора на пряка слънчева светлина и други източници на нагриване. Не поставяйте телевизора върху други уреди, които излъчват топлина, напр. видео плейър или аудио усилвател. Не поставяйте върху телевизора източници на открит пламък, като например запалени свещи.

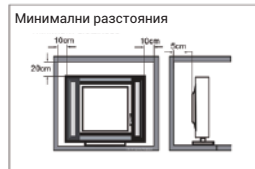

Ако телевизорът е вграден в шкаф или подобно затворено пространство, осигурете минималните необходими разстояния. Натрупаната топлина може да намали полезния живот на телевизора, а може също да бъде опасна.

Забележка: Уредът е предназначен за употреба в умерен климат.

Внимание:

Телевизорът може да падне и да причини сериозни наранявания или смърт. Много от нараняванията, особено на деца, могат да се избегнат чрез прости предохранителни мерки, като:

- ВИНАГИ използвайте шкафове или стойки, или препоръчания от производителя на телевизора начин за монтаж.
- ВИНАГИ използвайте мебели, които могат безопасно да поддържат телевизора.
- ВИНАГИ се уверявайте, че телевизорът не води до прегряване на повърхностите на мебелите, на които е поставен.
- ВИНАГИ информирайте децата, че е опасно да се катерят по мебелите, за да достигнат до телевизора или неговите бутони.
- ВИНАГИ разполагайте свързаните с телевизора кабели така, че да не могат да предизвикат препъване, да бъдат издърпани или захванати.
- НИКОГА не поставяйте телевизора на неподходящи места.
- НИКОГА не поставяйте телевизора на високи мебели (например шкафове или библиотеки), без да захванете мебелите и телевизора за подходяща опора.
- НИКОГА не поставяйте платове или други материци между телевизора и поддържащите го мебели.
- НИКОГА не поставяйте предмети, които могат да изкушат децата да се катерят, като играчки и дистанционни управления, върху телевизора или мебелите, на които е поставен.

Ако телевизорът трябва да бъде прибран за съхранение или да бъде преместен, имайте предвид и прилагайте горепосочените инструкции.

ПОДГОТОВКА

ВАЖНО: Не прилагайте натиск върху екрана, за да не повредите целостта на дисплея. Гаранцията на производителя не покрива повреди поради неправилна употреба или монтаж.

ПОСТАВЯНЕ НА СТОЙКАТА

ВАЖНО: Преди да използвате телевизора, трябва да го монтирате на стойката.

1. Поставете телевизора с екрана надолу на мека и равна повърхност (одеяло, стиропор, мека тъкан и др.), за да избегнете повреда.
2. Монтирайте стойката към долната част на телевизора с 6-те винта.

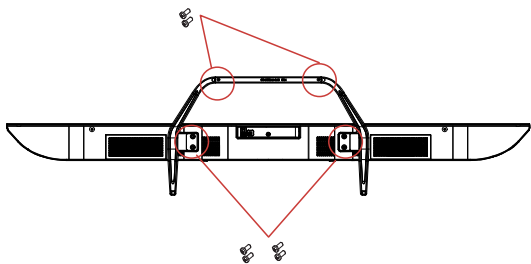

ЗАБЕЛЕЖКА

Телевизорът с монтирана стойка трябва да изглежда по този начин.

ПОДГОТОВКА НА LED ТЕЛЕВИЗОРА ЗА МОНТАЖ НА СТЕНА

Препоръчваме да осигурите разстояние от минимум 2,36 инча (60 mm) между телевизора и стената, за да избегнете съприкосновение с кабелите. Преди да монтирате телевизора на стената, трябва да премахнете стойката.

С цел безопасност използвайте само стойки за стена по стандарт UL, подходящи за минималното тегло на телевизора без стойка.

За да монтирате стойка за стена на телевизора:

1. Развийте винтовете, които придържат стойката на телевизора.
2. Свалете стойката от телевизора.
3. Монтирайте стойката за стена към гърба на телевизора, като използвате четири винта. За да монтирате стойката към стената, следвайте инструкциите в ръководството за употреба на стойката за стена.

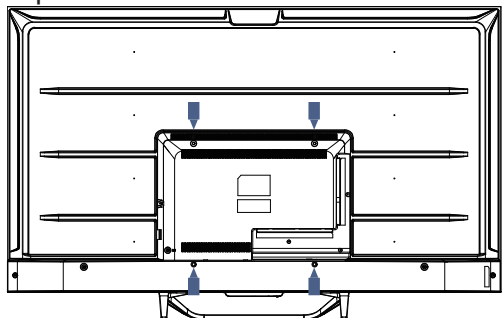

ЗАБЕЛЕЖКА

Стойката за стена не е включена в комплекта.

4. Завийте винтовете за монтаж на стена (M6 x 12 mm - 4 бр.) към задната страна на LED телевизора, като приложите момент на натягане 12 kgf.cm.

ВКЛЮЧВАНЕ НА ТЕЛЕВИЗОРА

1. Монтирайте стойката и поставете телевизора на стабилна основа.

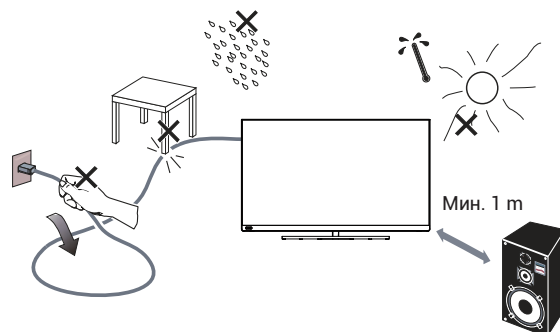

ЗАБЕЛЕЖКА

- Мястото, на което ще поставите телевизора, трябва да осигурява безпрепятствен въздушен поток. Не покривайте вентилационните отвори на задния капак.
 - За да предотвратите опасни ситуации, не трябва да поставяте върху уреда източници на открит пламък, като например свещи.
 - Избягвайте да излагате уреда на топлина, пряка слънчева светлина, дъжд или вода. Не излагайте уреда на капки или пръски вода.
2. Свържете кабела за антената или телевизионен кабел към гнездото за антена **ANT IN** от задната страна на телевизора.
 3. Дистанционно управление: Свалете капака на отделението за батериите. Поставете 2 батерии (Тип AAA 1,5 V).

ВНИМАНИЕ: При поставяне на неподходящ тип батерии съществува риск от пожар или експлозия.

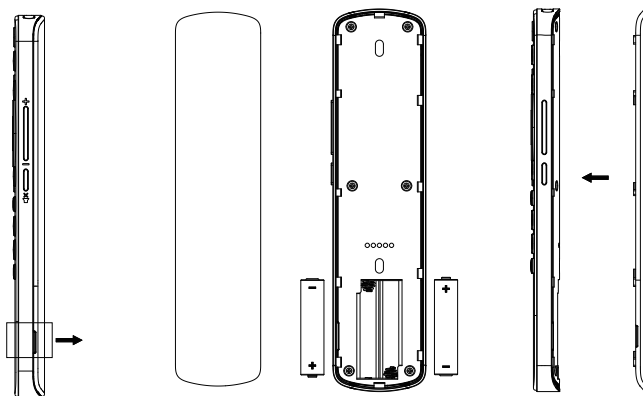

4. Захранване: Включете кабела в подходящ контакт.

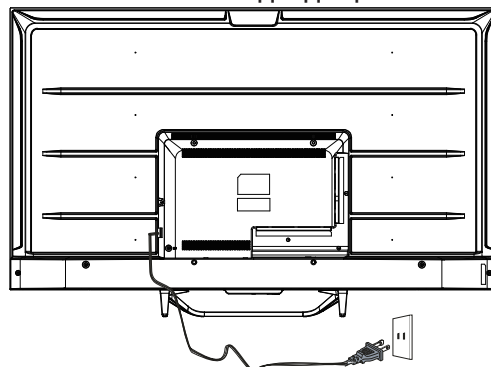

5. Включете телевизора: Натиснете бутона  на дистанционното управление или бутона **ВКЛ./ИЗКЛ.** на панела за управление на телевизора.

СВЪРЗВАНЕ И УПРАВЛЕНИЕ НА ПЕРИФЕРНИ УСТРОЙСТВА

БУТОНИ ЗА УПРАВЛЕНИЕ

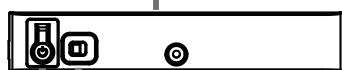
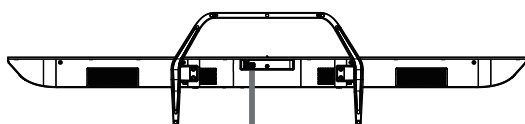
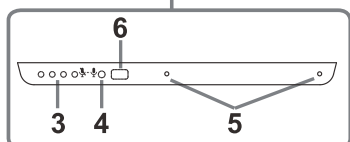
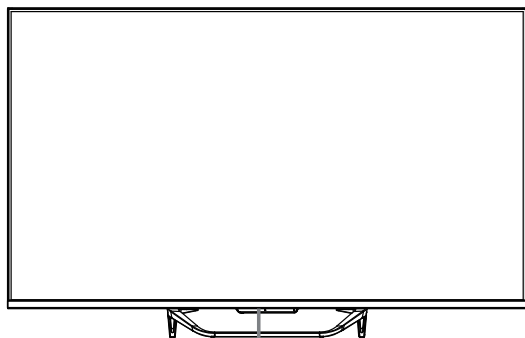

1. Включване / Изключване

2. Включване / Изключване на глас
 - 🗣️ Активиране на гласов асистент
 - 🗣️ Деактивиране на гласов асистент

Плъзнете надясно, за да включите – индикаторът ще светне и след това ще изгасне, гласовата функция е инициализирана. Можете да кажете „Ok Google“, за да използвате гласовата функция. Индикаторът ще светне, когато телевизорът приема глас, след това кажете гласовата команда.

Плъзнете наляво, за да изключите гласовата функция – индикаторът ще светне в жълто.

3. Индикатор за гласов асистент
4. Приемник на сигнала на дистанционното управление
5. Приемник на гласов сигнал
6. LED индикатор на захранването

ЗАБЕЛЕЖКА

За да използвате гласово управление, телевизорът трябва да е свързан към интернет.

Преди да използвате гласово управление, трябва да поставите превключвателя във включена позиция.

За да използвате гласово управление, трябва да влезете в своя GOOGLE акаунт.

АКСЕСОАРИ

Дистанционно управление - 1 бр.

Ръководство за употреба - 1 бр.

Винтове - 6 бр.

Кратко начално ръководство - 1 бр.

Гаранционна карта - 1 бр.

СВЪРЗВАНЕ НА ПЕРИФЕРНИ УСТРОЙСТВА



Всички портове за свързване са както следва (от ляво надясно):

LAN, OPTICAL (Оптичен кабел), VIDEO (Видео вход), L (Ляв канал), R (Десен канал), HDMI4, HDMI3, HDMI2,



Всички портове за свързване са както следва (от ляво надясно):

HDMI1 (eARC/ARC), LNB IN (Сателит), ANT IN (Антенa/Кабел), USB1, USB2, EARPHONE (Слушалки), CI (Общ интерфейс).

СВЪРЗВАНЕ

АУДИО-ВИДЕО УСТРОЙСТВА

Телевизорът има един групов аудио-видео интерфейс за удобно свързване на VCR, DVD или други видео устройства.

Направете справка и в ръководството за употреба на съответното устройство.

Можете да използвате входните портове от задната страна на телевизора, както е посочено по-долу.

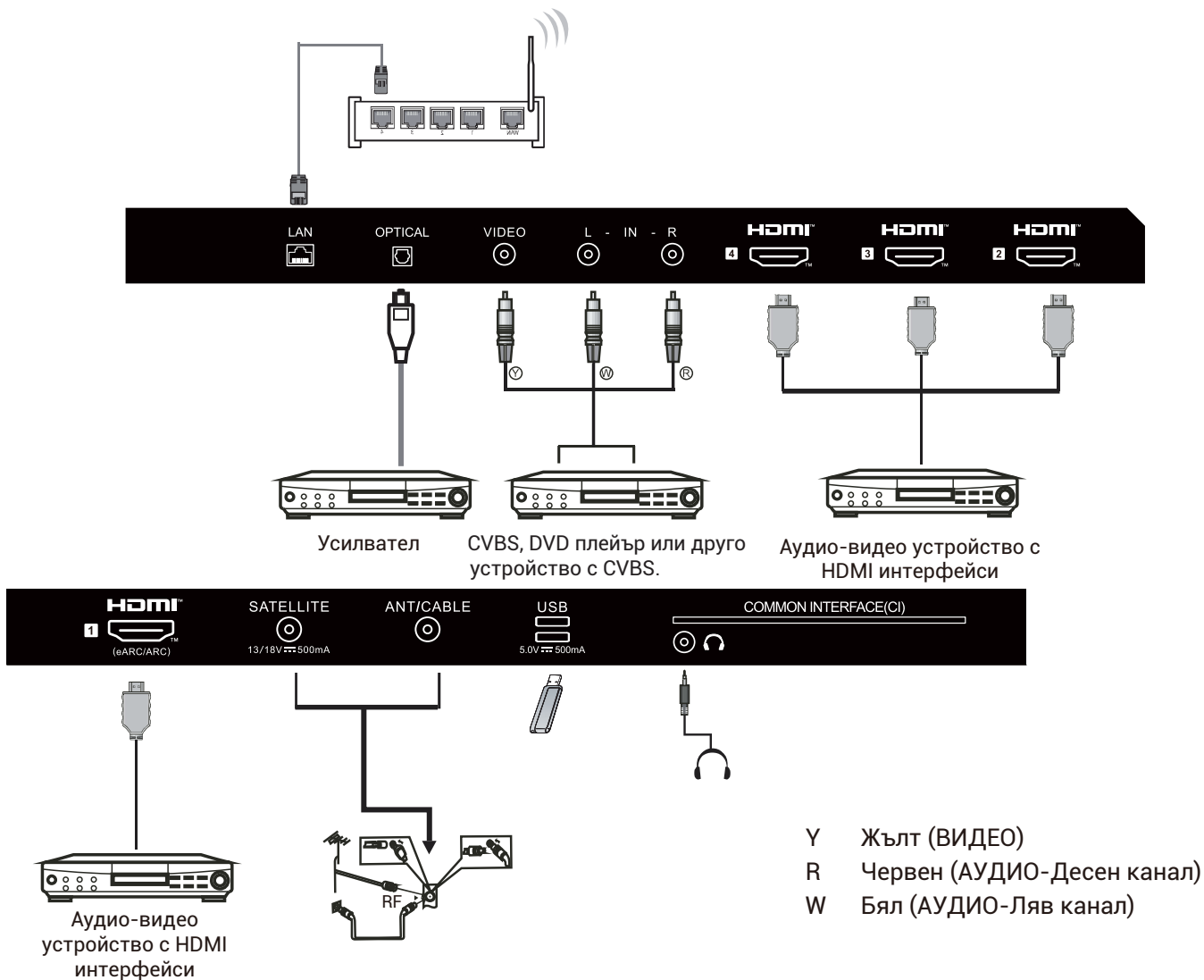

Към него могат да бъдат свързани следните устройства: VCR, мултимедиен диск плейър, DVD, видеокамера, видео игра, стерео система и др.

Забележка:

Възможно е някои устройства с нестандартен сигнал да не се поддържат.

ИНСТРУКЦИИ ЗА РАБОТА

ИЗПОЛЗВАНЕ НА ДИСТАНЦИОННОТО УПРАВЛЕНИЕ

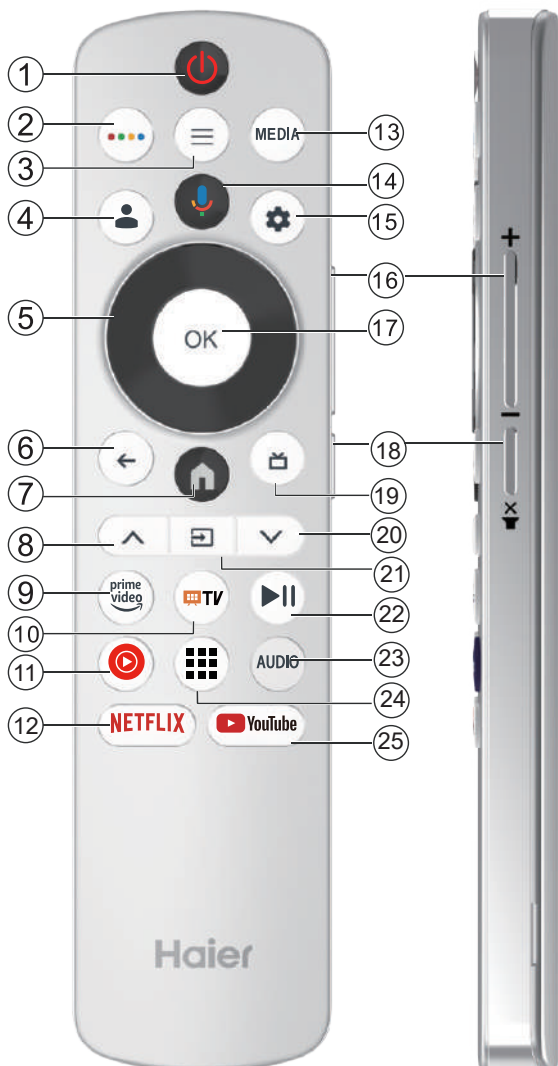

№	Елемент	Описание
1	 ЗАХРАНВАНЕ	Натиснете за включване или изключване на телевизора. Когато телевизорът е изключен, той все още е под напрежение. За да изключите напълно от напрежението, извадете щепсела от контакта.
2		Натиснете, за да отворите MAGIC BOARD.
3		Натиснете, за да отворите или затворите екранното меню.
4		Натиснете, за да влезете в Google TV. (При настройка на основна телевизия този бутон не работи)
5		Натиснете, за да се придвижвате в екранното меню.
6		Връщане към предишното меню.
7		Натиснете, за да отворите началната страница.
8		Натиснете за смяна на телевизионните канали.
9	 prime video	Натиснете, за да отворите prime video, където да гледате телевизионни програми и филми (необходима е връзка с интернет).
10	 TV	Натиснете, за да отворите Live TV.
11		Натиснете, за да отворите YouTube Music.
12	 NETFLIX	Натиснете, за да отворите NETFLIX.
13	MEDIA	Натиснете, за да отворите мултимедиен плейър.
14		Натиснете, за да отворите Google асистент или да стартирате гласово търсене.
15		Натиснете, за да отворите менюто с настройки.
16	VOL+VOL-	Натиснете VOL+ за увеличаване или VOL- за намаляване на звука.
17	OK	Въвеждане на избраната опция или извършване на избраната операция.
18		Натиснете, за изключите или да включите звука.
19		Натиснете, за да изведете електронния справочник на програмите в режим на телевизия.
20		Натиснете за смяна на телевизионните канали.
21		Натиснете, за да отворите списъка с източници на сигнал.
22		Натиснете, за да пуснете или поставите на пауза в режим на мултимедия.
23	AUDIO	Натиснете, за да превключите към аудио файлове.
24		Натиснете, за да отворите приложенията.
25	 YouTube	Натиснете, за да отворите YouTube.

ИНСТРУКЦИИ ЗА РАБОТА

ПЪРВОНАЧАЛНА НАСТРОЙКА

Когато включите телевизора за първи път, на екрана се появява съветникът за настройка, чрез който можете да зададете основните настройки. Следвайте текстовите съвети за първоначална настройка.

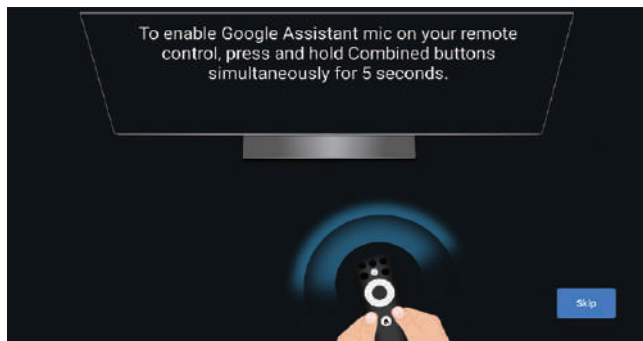

Тази функция се използва за въвеждане на код за сдвояване на дистанционното управление. След успешно сдвояване, можете да използвате дистанционното с Bluetooth за управление на телевизора.

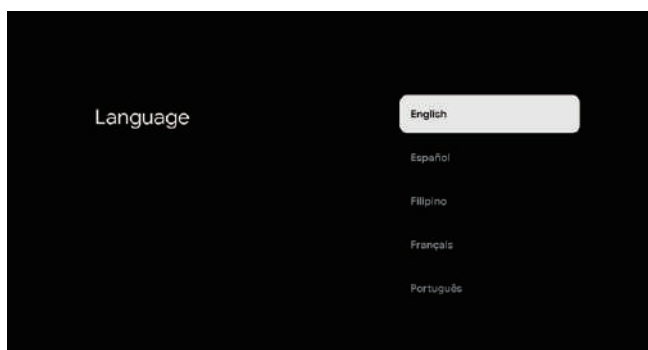

Използвайте бутоните ▲/▼, за да изберете език на системата, и след това натиснете **OK** за потвърждаване на езика.

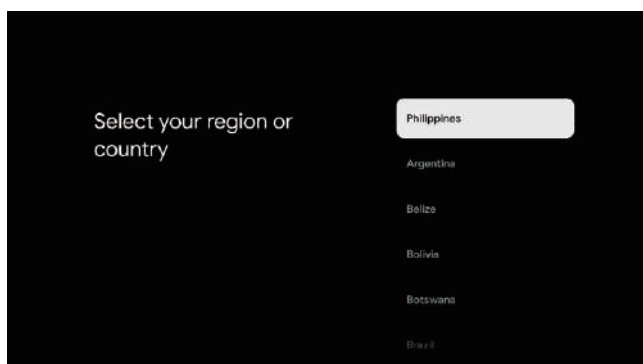

Използвайте бутоните ▲/▼, за да изберете държава/регион, и след това натиснете **OK** за потвърждение.

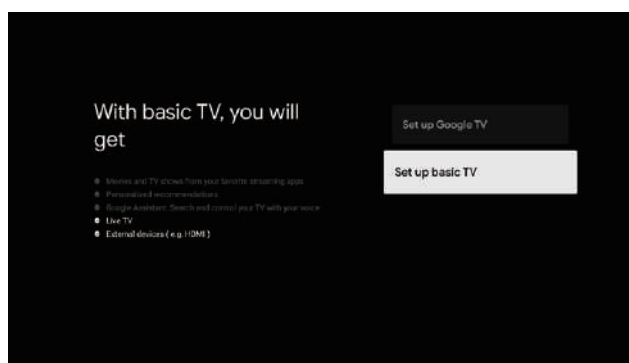

Използвайте бутоните ▲/▼, за да изберете Set up basic TV (Основна настройка на телевизор), и след това натиснете **OK** за потвърждение.

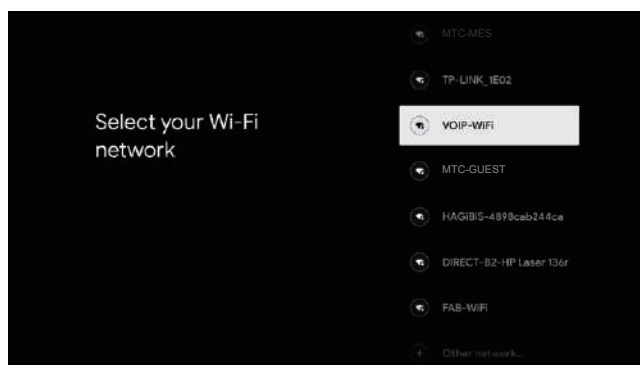

Използвайте бутоните ▲/▼, за да изберете WiFi мрежа за свързване, и след това натиснете **OK** и въведете паролата, за да потвърдите и да се свържете към мрежата.

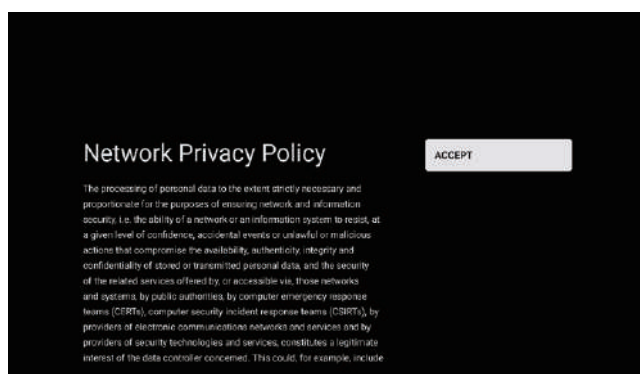

Натиснете **Accept** (Приемам), за да приемете условията на Network Privacy Policy (Политиката за поверителност в мрежата).

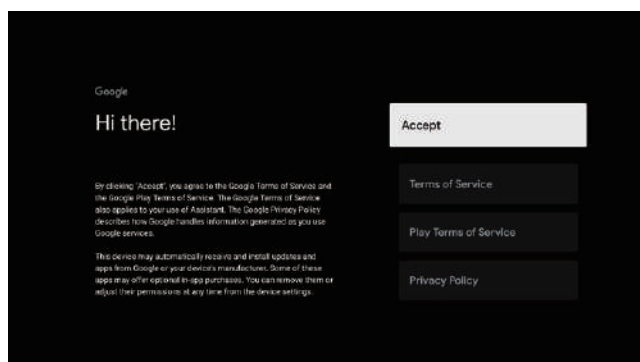

ИНСТРУКЦИИ ЗА РАБОТА

Натиснете **Асепт (Приемам)**, за да приемете **Общите условия на Google** с цел подобряване на потребителското изживяване.

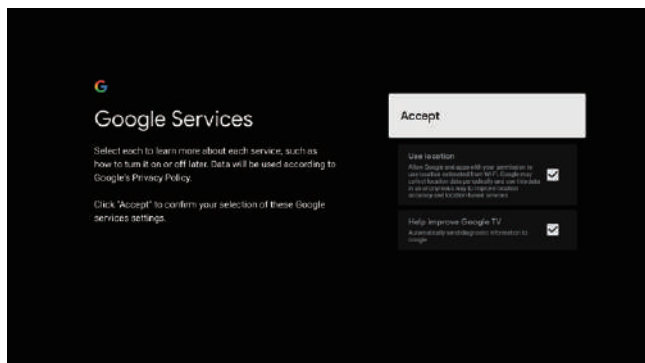

Натиснете **Асепт (Приемам)**, за да приемете **Услугите на Google** с цел подобряване на потребителското изживяване.



Използва се за задаване на парола за устройството с цел осигуряване на сигурност и поверителност.

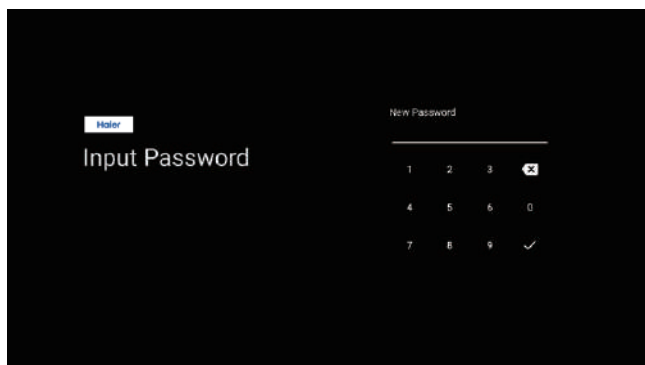

Използвайте клавиатурата на дистанционното управление или екранната клавиатура, за да въведете 4-цифрена парола, след което ще преминете автоматично към следващия екран.

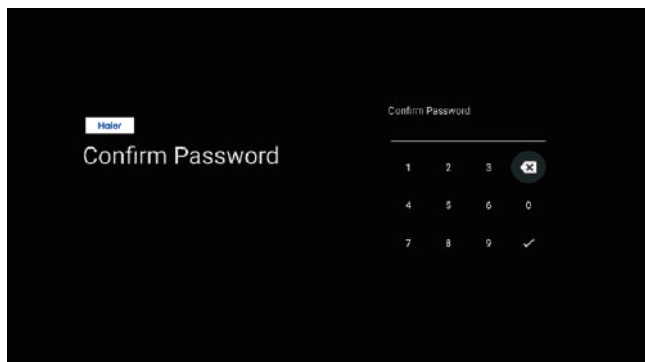

Въведете отново паролата, за да я потвърдите, като използвате клавиатурата на дистанционното управление или екранната клавиатура.

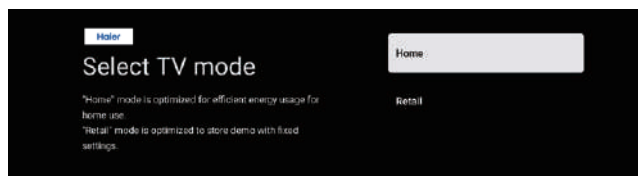

В екрана за избор на режим използвайте бутоните **▲/▼**, за да изберете **Home (Домашен) Mode**, и след това натиснете **ОК**.

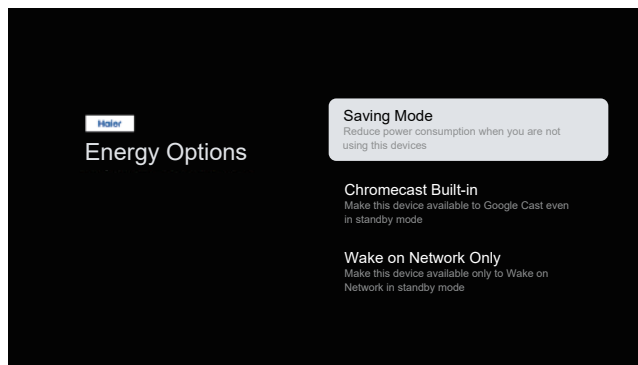

Изберете **Saving Mode (Икономичен режим)** и продължете към следващата стъпка.

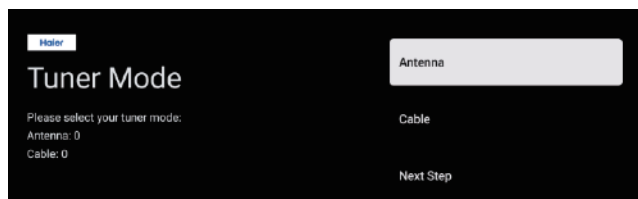

Изберете **Tuner Mode (Режим на тунер)**, за да осъществите търсене, след това натиснете **ОК** за потвърждение.

ИНСТРУКЦИИ ЗА РАБОТА

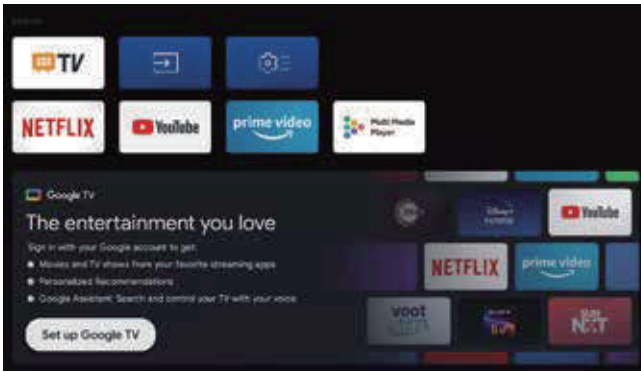

- В потребителския интерфейс можете да превключвате настройките на основната телевизия и Google TV.

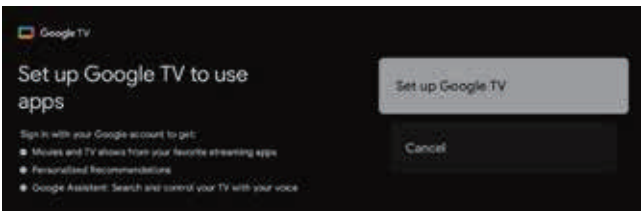

Използвайте бутоните ▲/▼, за да изберете Set up Google TV (Настройка на Google TV) и след това натиснете OK, за да извършите настройките.

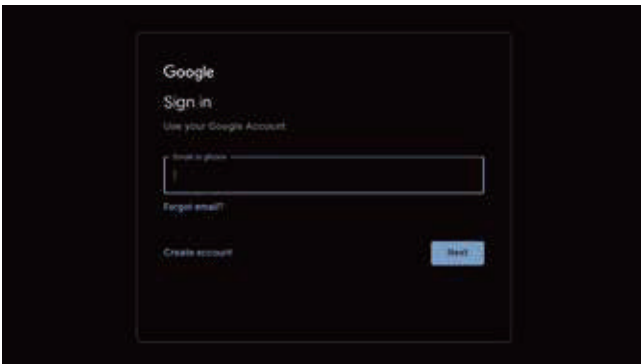

Изберете своя акаунт в Google и влезте в него

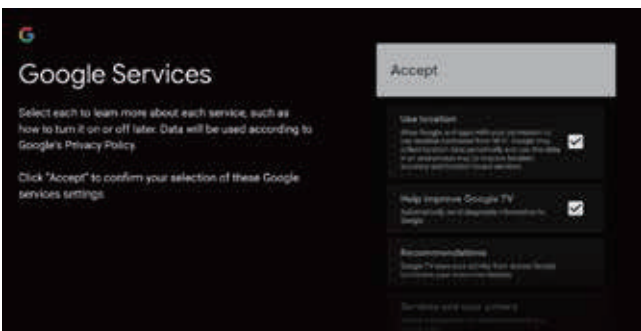
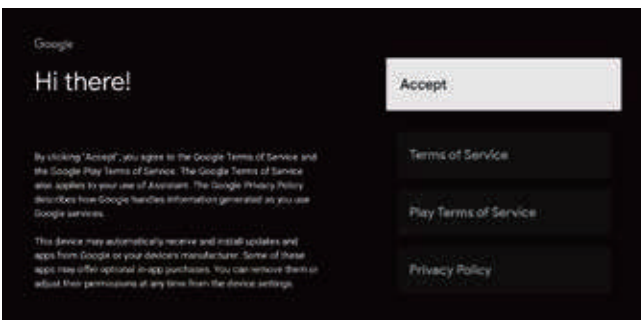

Натиснете Асепт (Приемам), за да приемете Общите условия на Google с цел подобряване на потребителското изживяване.

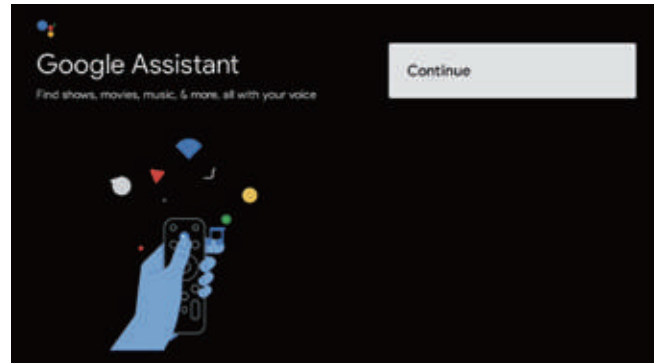

Натиснете, за да изберете, и след това натиснете OK, за да продължите.

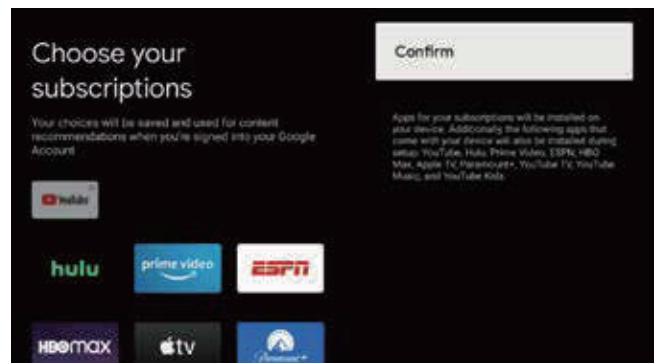

Използвайте бутоните ▲/▼, за да изберете Choose your subscriptions (Изберете своите абонаменти), и натиснете OK.

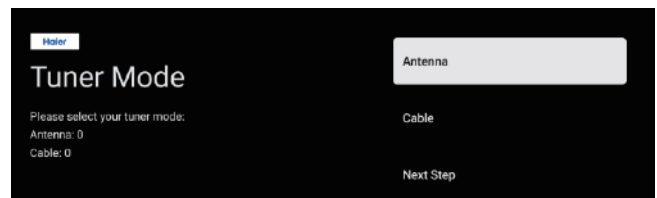

ИНСТРУКЦИИ ЗА РАБОТА

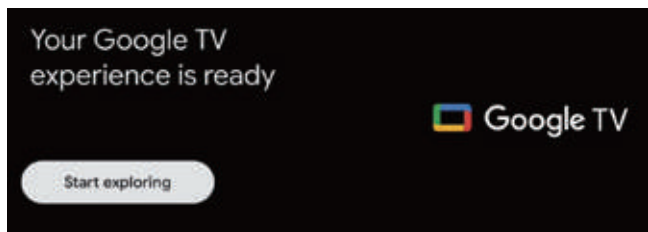

Настройките за Google TV са направени, натиснете ОК, за да разгледате възможностите.

НАЧАЛЕН ЕКРАН

След като завършите стъпките в съветника за настройки, можете да гледате телевизия и да отворите началния екран.

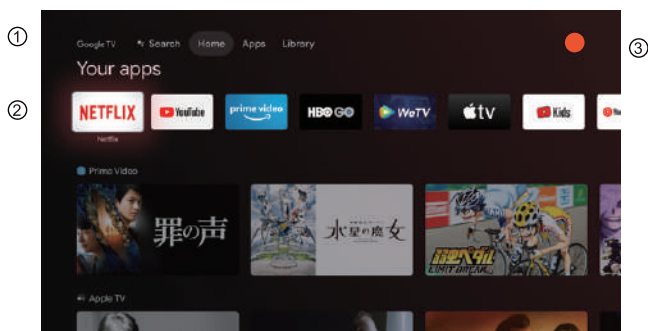

- ① **Search** Използвайте, за да отворите Google асистент или да стартирате гласово търсене.
Home Използвайте, за да отворите началната страница на телевизора.
Apps Използвайте, за да отворите списъка с инсталираните приложения и да добавите любими приложения.
Library Използвайте за преглед на съдържание, което е закупено или наето с потребителски акаунт.
- ② Списък на инсталираните приложения и полученото съдържание от инсталирани програми.
- ③ Използвайте, за да отворите информация, настройки, час, източници и снимка на Вашия акаунт.
Настройки: Тук могат да бъдат конфигурирани различни настройки. За подробности относно настройките вижте следващите пояснения.
Източници: Икона за избор на източник на сигнал.
Картина: Потребителят може да настрои картината на телевизора. Вижте страница 12 за подробни инструкции за настройка.

ПРИДВИЖВАНЕ В ЕКРАННОТО МЕНЮ

Има два начина за отваряне на екранното меню. Първият - в режим Live TV (Телевизия на живо) натиснете бутона за меню, за да изведете TV options (Опции за телевизия), след това използвайте бутоните ▲/▼/◀/▶, за да изберете менюто Settings (Настройки), и накрая натиснете ОК за потвърждение. Вторият - в началната страница HOME, използвайте бутона ▶, за да изберете иконата ⚙ в менюто, и след това натиснете ОК за потвърждение.

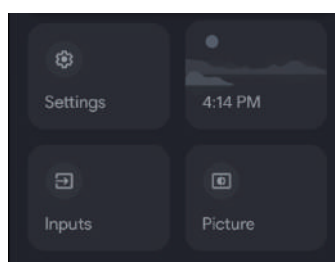
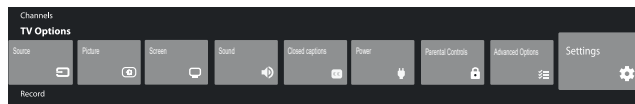

Използвайте бутоните ▲/▼, за да изберете настройката, която искате да промените. Натиснете ОК, за да отворите съответната настройка.

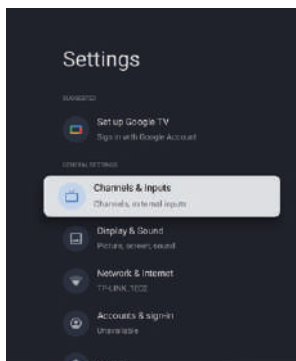

Натиснете бутона BACK (Връщане назад), за да се върнете в предишното меню. Ако сте в основното меню, когато натиснете бутона BACK (Връщане назад), екранното меню ще се затвори.

ИНСТРУКЦИИ ЗА РАБОТА

КАНАЛИ

Menu -> Settings -> Channels & Inputs -> Channels
(Меню -> Настройки -> Канали и източници -> Канали).

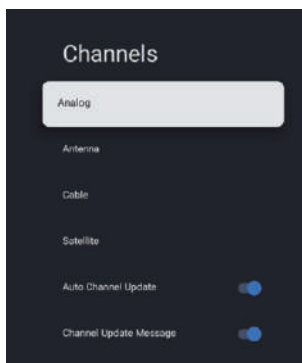

Analog/Antenna/Cable/Satellite (Аналогови/Ефирни/Кабелни/Сателитни) - Използвайте бутоните ▲/▼, за да изберете опцията, и след това натиснете бутона ОК, за да отворите подменюто.

Auto Channel Update (Автоматично актуализиране на каналите) - Натиснете бутона ОК, за да изберете **ON/OFF (Вкл./Изкл.)**. Когато изберете ON (Вкл.), системата автоматично ще сканира и актуализира каналите, след като изминат 5 минути в режим на готовност.

Channel Update Message (Съобщение за актуализация на каналите) - Натиснете бутона ОК, за да изберете **ON/OFF (Вкл./Изкл.)**. Когато изберете ON (Вкл.), системата ще показва съобщението за актуализация.

Забележка: Наличният източник може да е различен в зависимост от модела.

ИЗТОЧНИЦИ

Menu -> Settings -> Channels & Inputs -> Inputs
(Меню -> Настройки -> Канали и източници -> Източници)

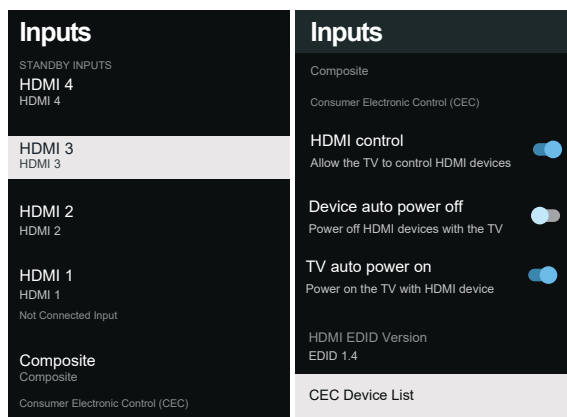

Inputs (Източници) – Използвайте бутоните ▲/▼, за да изберете опцията, и след това натиснете **ОК**, за да отворите съответното подменю.

HDMI control (Управление на HDMI) – Използвайте бутоните ▲/▼, за да изберете опцията, и след това натиснете **ОК**, за да изберете ВКЛ./ИЗКЛ.

Device auto power off (Автоматично изключване на устройството) – Използвайте бутоните ▲/▼, за да изберете опцията, и след това натиснете **ОК**, за да изберете ВКЛ./ИЗКЛ.

ИНСТРУКЦИИ ЗА РАБОТА

TV auto power on (Автоматично включване на телевизора) – Използвайте бутоните ▲/▼, за да изберете опцията, и след това натиснете **OK**, за да изберете ВКЛ./ИЗКЛ.

HDMI EDID Version (Версия на HDMI EDID) – показва версията на EDID.

CEC Device List (Списък с CEC устройства) – Използвайте бутоните ▲/▼, за да изберете опцията, и след това натиснете **OK**, за да отворите съответното подменю.

ДИСПЛЕЙ И ЗВУК

Menu -> Settings -> Display & Sound (Меню -> Настройки -> Дисплей и звук)

В това меню можете да настроите картината, звука и аудио изхода на телевизора.

1. Използвайте бутоните ▲/▼, за да изберете настройката, която искате да промените.
2. Натиснете бутона **OK** за потвърждение.
3. След като приключите с настройките, натиснете бутона **BACK** (Връщане назад), за да се върнете към предишното меню.

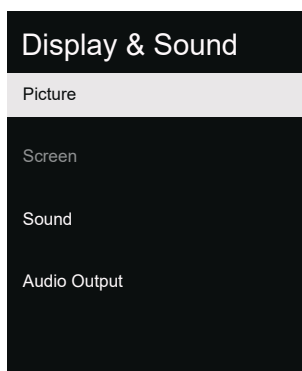

КАРТИНА

Menu -> Settings -> Display & Sound -> Picture (Меню -> Настройки -> Дисплей и звук -> Картина).

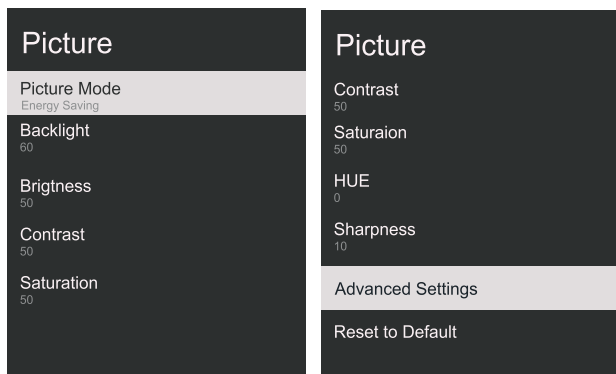

Picture Mode (Режим на картината) – Използвайте бутоните ▲/▼, за да изберете опцията, и след това натиснете **OK**, за да отворите съответното подменю. (Опции: user (Потребителска), Standard (Стандартна), Vivid (Ярка), Sport (Спорт), Movie (Филм), Game (Игра), Energy saving (Енергоспестяваща)).

Backlight / Brightness / Contrast / Saturation / HUE / Sharpness (Подсветка / Яркост / Контраст / Наситеност / Оттенък / Острота) – Използвайте бутоните ▲/▼, за да изберете опцията, и след това натиснете **OK**, за да изберете ВКЛ./ИЗКЛ.

Натиснете бутона ◀, за да намалите стойността на параметъра. Натиснете бутона ▶, за да увеличите стойността на параметъра.

Advanced Settings (Разширени настройки) – Използвайте бутоните ▲/▼, за да изберете опцията, и след това натиснете **OK**, за да отворите съответното подменю.

Reset to Default (Възстановяване на фабричните настройки) – Изберете, за да възстановите фабричните настройки по подразбиране.

ЗВУК

Menu -> Settings -> Display & Sound -> Sound (Меню -> Настройки -> Дисплей и звук -> Звук).

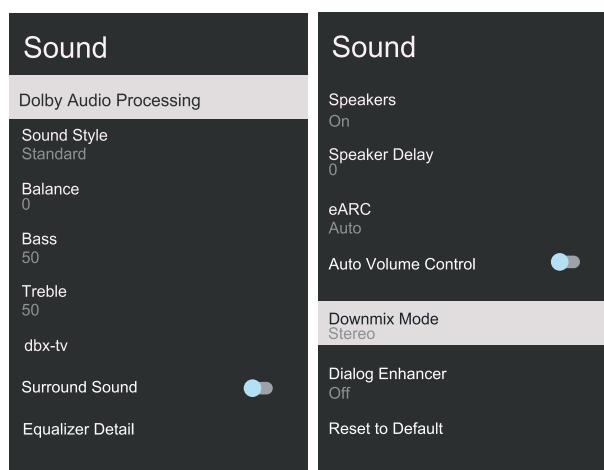

Dolby Audio Processing (Обработка на звука Dolby Audio) – Използвайте бутоните ▲/▼, за да изберете опцията, и след това натиснете **OK**, за да отворите съответното подменю.

Sound Style (Стил на звука) – Използвайте бутоните ▲/▼, за да изберете опцията, и след това натиснете **OK**, за да отворите съответното подменю.

(Опции: user (Потребителски), Standard (Стандартен), Night (Нощен), Sport (Спорт), Movie (Филм), Music (Музика), News (Новини)).

Balance / Bass / Treble (Баланс / Ниски / Високи) – Използвайте бутоните ▲/▼, за да изберете опцията, и след това натиснете **OK**, за да отворите подменюто.

Натиснете бутона ◀, за да намалите стойността на параметъра.

Натиснете бутона ▶, за да увеличите стойността на параметъра.

dbx-tv – Използвайте бутоните ▲/▼, за да изберете опцията, и след това натиснете **OK**, за да отворите съответното подменю.

Surround Sound (Съраунд звук) – Използвайте бутоните ▲/▼, за да изберете опцията, и след това натиснете **OK**, за да изберете ВКЛ./ИЗКЛ.

ИНСТРУКЦИИ ЗА РАБОТА

Equalizer Detail (Разширен еквалайзер) – Използвайте бутоните ▲/▼, за да изберете опцията, и след това натиснете **OK**, за да отворите съответното подменю.

Speakers (Високоговорители) – Използвайте бутоните ▲/▼, за да изберете опцията, и след това натиснете **OK**, за да изберете ВКЛ./ИЗКЛ.

Speaker Delay (Забавяне на високоговорител) – Използвайте бутоните ▲/▼, за да изберете опцията, и след това натиснете **OK**, за да изберете ВКЛ./ИЗКЛ.

Натиснете бутона ◀, за да намалите стойността на параметъра. Натиснете бутона ▶, за да увеличите стойността на параметъра.

eARC – Използвайте бутоните ▲/▼, за да изберете опцията, и след това натиснете **OK**, за да изберете Автоматично/ИЗКЛ.

Auto Volume Control (Автоматична сила на звука) – Използвайте бутоните ▲/▼, за да изберете опцията, и след това натиснете **OK**, за да изберете ВКЛ./ИЗКЛ.

Downmix Mode (Режим на намаляване броя на каналите) – Използвайте бутоните ▲/▼, за да изберете опцията, и след това натиснете **OK**, за да отворите съответното подменю.

(Опции: Stereo (Стерео), Surround (Съраунд)).

Dialog Enhancer (Увеличаване на говора) – Използвайте бутоните ▲/▼, за да изберете опцията, и след това натиснете **OK**, за да отворите съответното подменю.

(Опции: Off (Изкл.), Low (Ниско), Medium (Средно) и High (Високо)).

Reset to Default (Възстановяване на фабричните настройки) – Изберете, за да възстановите фабричните настройки по подразбиране.

АУДИО ИЗХОД

Menu -> Settings -> Display & Sound -> Audio Output (Меню -> Настройки -> Дисплей и звук -> Аудио изход).

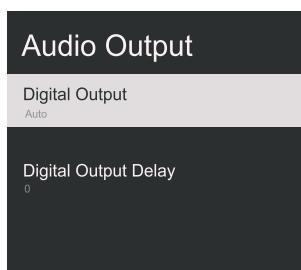

Audio Output (Цифров изход) – Използвайте бутоните ▲/▼, за да изберете опцията, и след това натиснете **OK**, за да отворите съответното подменю. (Опции: Auto (Автоматично), Bypass (Заобикаляне), PCM, Dolby Digital Plus и Dolby Audio-Dolby Digital).

Digital Output Delay (Забавяне на цифров изход) – Използвайте бутоните ▲/▼, за да изберете опцията, и след това натиснете **OK**, за да отворите подменюто.

Натиснете бутона ◀, за да намалите стойността на параметъра.

Натиснете бутона ▶, за да увеличите стойността на параметъра.

МРЕЖА

Menu -> Settings -> Network & Internet (Меню -> Настройки -> Мрежа и интернет)

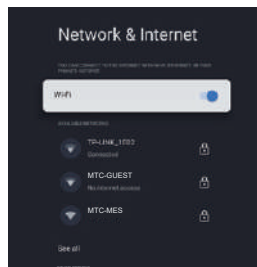

1. Използвайте бутоните ▲/▼, за да изберете настройката, която искате да промените.
2. Натиснете бутона **OK**, за да потвърдите.
3. След като приключите с настройките, натиснете бутона **OK**, за да запазите настройките и да се върнете към предишното меню.

АКАУНТИ И ВХОД

1. Menu -> Settings -> Accounts & Sign-in (Меню -> Настройки -> Акаунти и вход).
2. В началната страница HOME използвайте бутоните ▲/▼, за да изберете Set up Google TV (Настройка на Google TV) и преминете към следващата стъпка.

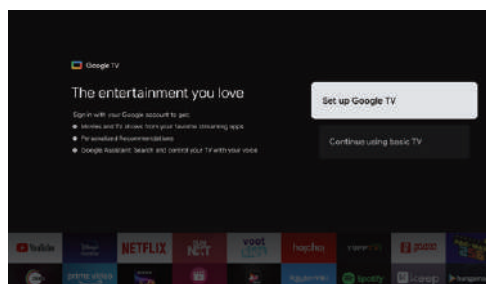

Изберете Set up Google TV (Настройка на Google TV) и преминете към следващата стъпка – въведете поробителското име и паролата. Следвайте инструкциите, за да направите съответните настройки.

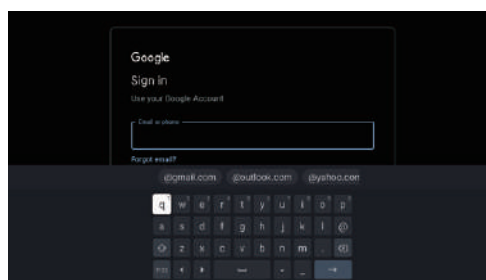

ИНСТРУКЦИИ ЗА РАБОТА

ПОВЕРИТЕЛНОСТ

Menu -> Settings -> Privacy (Меню -> Настройки -> Поверителност).

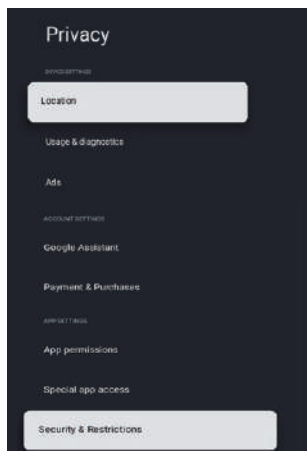

В това меню можете да зададете местоположение, използване и диагностика, и др. за телевизора.

1. Използвайте бутоните ▲/▼, за да изберете настройката, която искате да промените.
2. Натиснете бутона **OK**, за да потвърдите.
3. След като приключите с настройките, натиснете бутона **BACK** (Връщане назад), за да се върнете към предишното меню.

МЕСТОПОЛОЖЕНИЕ

Menu -> Settings -> Privacy -> Location (Меню -> Настройки -> Поверителност -> Местоположение).

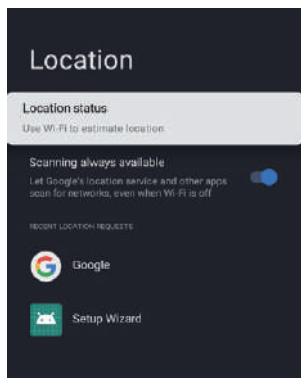

Location status (Статус на местоположението) – Използвайте бутоните ▲/▼, за да изберете опцията, и след това натиснете **OK**, за да отворите съответното подменю.

(Опции: Use Wi-Fi to estimate location (Използване на Wi-Fi за определяне на местоположението), Off (Изкл.))

Scanning always available (Винаги включено сканиране) – Използвайте бутоните ▲/▼, за да изберете опцията, и след това натиснете **OK**, за да изберете ВКЛ./ИЗКЛ.

ИЗПОЛЗВАНЕ И ДИАГНОСТИКА

Menu -> Settings -> Privacy -> Usage & Diagnostics (Меню -> Настройки -> Поверителност -> Използване и диагностика)

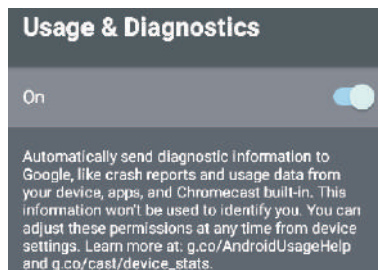

Usage & Diagnostics (Използване и диагностика) – Използвайте бутоните ▲/▼, за да изберете опцията, и след това натиснете **OK**, за да изберете ВКЛ./ИЗКЛ.

ПРИЛОЖЕНИЯ

Menu -> Settings -> Apps (Меню -> Настройки -> Приложения).

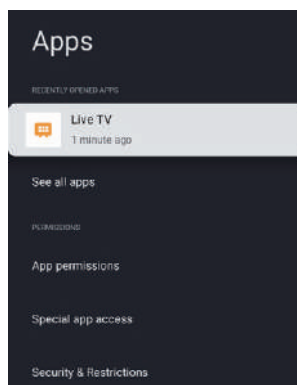

В това меню можете да задавате разрешения за приложенията и да прегледате списъка с приложения

1. Използвайте бутоните ▲/▼, за да изберете настройката, която искате да промените.
2. Натиснете бутона **OK**, за да потвърдите.
3. След като приключите с настройките, натиснете бутона **BACK** (Връщане назад), за да се върнете към предишното меню.

СИСТЕМА

Menu -> Settings -> System (Меню -> Настройки -> Система).

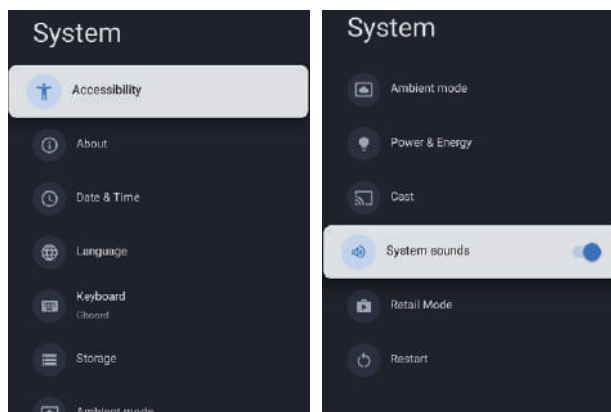

ИНСТРУКЦИИ ЗА РАБОТА

В това меню можете да видите информацията и настройките на телевизора.

1. Използвайте бутоните ▲/▼, за да изберете настройката, която искате да промените.
2. Натиснете бутона **OK**, за да потвърдите.
3. След като приключите с настройките, натиснете бутона **BACK** (Връщане назад), за да се върнете към предишното меню.

System sounds (Системни звуци) – Използвайте бутоните ▲/▼, за да изберете опцията, и след това натиснете **OK**, за да изберете ВКЛ./ИЗКЛ. За подробности относно системните настройки вижте следващите пояснения.

ДОСТЪПНОСТ

Menu -> Settings -> System -> Accessibility (Меню -> Настройки -> Система -> Достъпност).

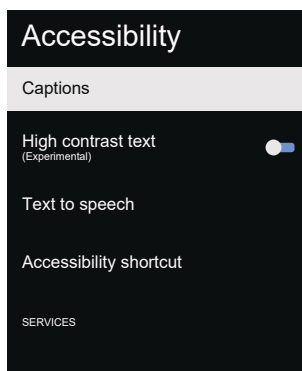

Captions (Надписи) – Използвайте бутоните ▲/▼, за да изберете опцията, и след това натиснете **OK**, за да отворите съответното подменю.

High contrast text (Текст с висок контраст) – Използвайте бутоните ▲/▼, за да изберете опцията, и след това натиснете **OK**, за да изберете ВКЛ./ИЗКЛ.

Text to speech (Текст в реч) – Използвайте бутоните ▲/▼, за да изберете опцията, и след това натиснете **OK**, за да отворите съответното подменю.

Accessibility shortcut (Кратък път за достъпност) – Използвайте бутоните ▲/▼, за да изберете опцията, и след това натиснете **OK**, за да отворите съответното подменю.

ИНФОРМАЦИЯ

Menu -> Settings -> System -> About (Меню -> Настройки -> Система -> Информация).

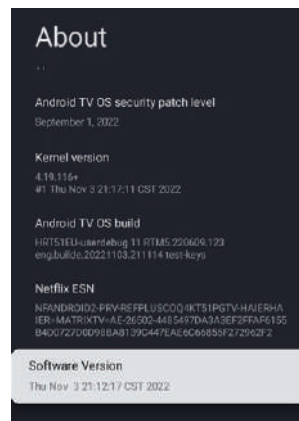
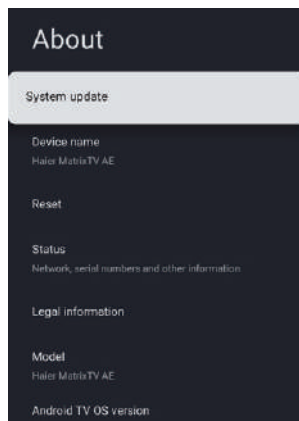

В това меню можете да изберете System update (Актуализация на системата), Reset (Нулиране) и да видите информация за телевизора.

1. Използвайте бутоните ▲/▼, за да изберете настройката, която искате да промените.
2. Натиснете бутона **OK**, за да потвърдите.
3. След като приключите с настройките, натиснете бутона **BACK** (Връщане назад), за да се върнете към предишното меню.

ДАТА И ЧАС

Menu -> Settings -> System -> Date & Time (Меню -> Настройки -> Система -> Дата и час).

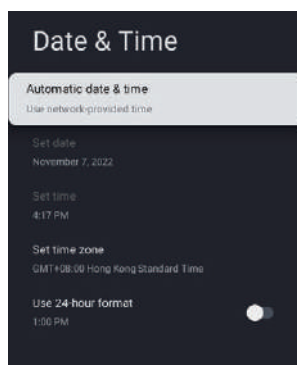

Automatic date & time (Автоматично задаване на дата и час) – Използвайте бутоните ▲/▼, за да изберете опцията, и след това натиснете **OK**, за да отворите съответното подменю. (Опции: Use network-provided time (Използване на времето на мрежата), Off (Изкл.))

ЗАБЕЛЕЖКА

- Когато настройката на Automatic date & time (Автоматично задаване на дата и час) е OFF (Изкл.), можете да използвате Manually adjusting date & time (Ръчно задаване на дата и час).

Set date (Задаване на дата) – Използвайте бутоните ▲/▼, за да изберете опцията, и след това натиснете **OK**, за да отворите съответното подменю.

Set date (Задаване на час) – Използвайте бутоните ▲/▼, за да изберете опцията, и след това натиснете **OK**, за да отворите съответното подменю.

ИНСТРУКЦИИ ЗА РАБОТА

Set time zone (Задаване на часова зона) – Използвайте бутоните ▲/▼, за да изберете опцията, и след това натиснете **OK**, за да отворите съответното подменю.

Use 24-hour format (Използване на 24-часов формат) – Използвайте бутоните ▲/▼, за да изберете опцията, и след това натиснете **OK**, за да изберете ВКЛ./ИЗКЛ.

ЕЗИК

Menu -> Settings -> System -> Language (Меню -> Настройки -> Система -> Език).

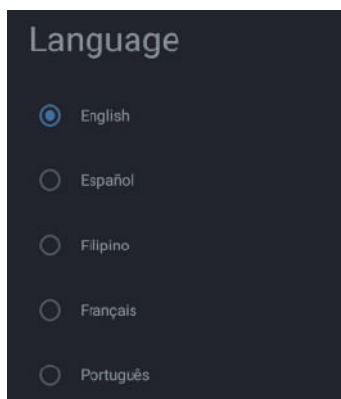

Language (Език) – Използвайте бутоните ▲/▼, за да изберете опцията, и след това натиснете **OK**, за да зададете избрания език.

КЛАВИАТУРА

Menu -> Settings -> System -> Keyboard (Меню -> Настройки -> Система -> Клавиатура).

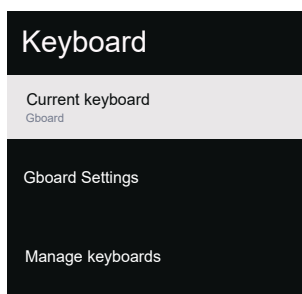

Current keyboard (Текуща клавиатура) – Използвайте бутоните ▲/▼, за да изберете опцията, и след това натиснете **OK**, за да отворите съответното подменю.

Gboard Settings (Настройки на Gboard) – Използвайте бутоните ▲/▼, за да изберете опцията, и след това натиснете **OK**, за да отворите съответното подменю.

Manage keyboards (Управление на клавиатури) – Използвайте бутоните ▲/▼, за да изберете опцията, и след това натиснете **OK**, за да отворите съответното подменю.

СЪХРАНЕНИЕ

Menu -> Settings -> System -> Storage (Меню -> Настройки -> Система -> Съхранение).

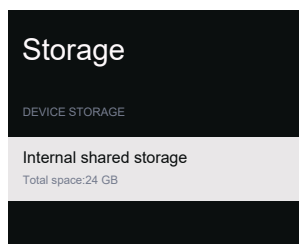

Internal shared storage (Вътрешно споделено хранилище) – Използвайте бутоните ▲/▼, за да изберете опцията, и след това натиснете **OK**, за да отворите съответното подменю.

РЕЖИМ НА ФОНОВО ОСВЕТЛЕНИЕ

Menu -> Settings -> System -> Ambient mode (Меню -> Настройки -> Система -> Фоново осветление).

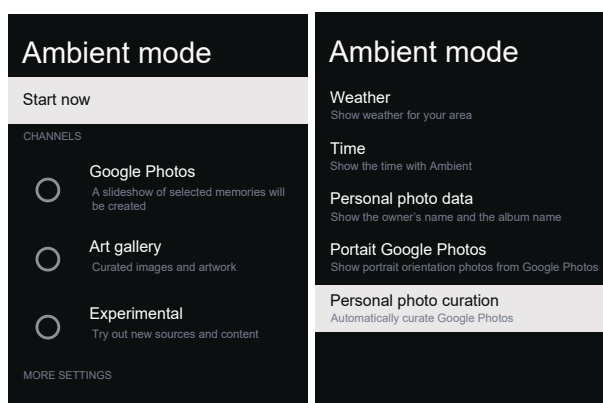

В това меню можете да включите режим на фоново осветление.

1. Използвайте бутоните ▲/▼, за да изберете настройката, която искате да промените.
2. Натиснете бутона **OK**, за да потвърдите.
3. След като приключите с настройките, натиснете бутона **BACK** (Връщане назад), за да се върнете към предишното меню.

ЗАХРАНВАНЕ И ЕНЕРГИЯ

Menu -> Settings -> System -> Power & Energy (Меню -> Настройки -> Система -> Захранване и енергия).

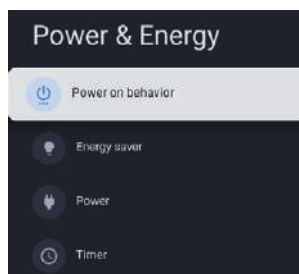

В това меню можете да зададете настройки за включване/изключване и икономия на енергия. (Опции: Power on behavior (Поведение при включване), Energy saver (Икономия на енергия), Power (Захранване) и Timer (Таймер))

1. Използвайте бутоните ▲/▼, за да изберете настройката, която искате да промените.
2. Натиснете бутона **OK**, за да потвърдите.

ИНСТРУКЦИИ ЗА РАБОТА

- След като приключите с настройките, натиснете бутона BACK (Връщане назад), за да се върнете към предишното меню.

ПОВЕДЕНИЕ ПРИ ВКЛЮЧВАНЕ

Menu -> Settings -> System -> Power & Energy -> Power on behavior (Меню -> Настройки -> Система -> Захранване и енергия -> Поведение при включване).

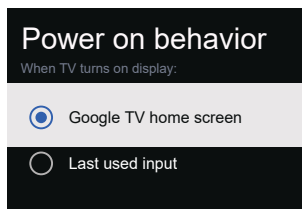

Използвайте бутоните ▲/▼, за да изберете опцията, и след това натиснете **OK** за потвърждение.

ИКОНОМИЯ НА ЕНЕРГИЯ

Menu -> Settings -> System -> Power & Energy -> Energy saver (Меню -> Настройки -> Система -> Захранване и енергия -> Икономия на енергия).

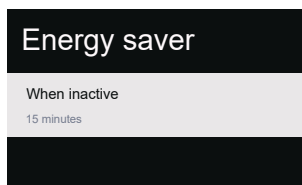

When inactive (При липса на активност) – Използвайте бутоните ▲/▼, за да изберете опцията, и след това натиснете **OK**, за да отворите съответното подменю. (Опции: 15 минути, 20 минути, 30 минути, 1 час, 4 часа, 8 часа, 12 часа, 24 часа, Never (Никога)).

ЗАХРАНВАНЕ

Menu -> Settings -> System -> Power & Energy -> Power (Меню -> Настройки -> Система -> Захранване и енергия -> Захранване).

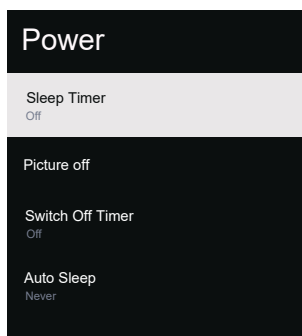

Sleep Timer (Таймер за заспиване) – Използвайте бутоните ▲/▼, за да изберете опцията, и след това натиснете **OK**, за да отворите съответното подменю.

(Опции: off (Изкл.), 10 минути, 20 минути, 30 минути, 40 минути, 50 минути, 60 минути, 90 минути, 120 минути)

Picture off (Изключване на картината) – Използвайте бутоните ▲/▼, за да изберете опцията, и след това натиснете **OK** за потвърждение.

Switch off timer (Таймер за изключване) – Използвайте бутоните ▲/▼, за да изберете опцията, и след това натиснете **OK**, за да отворите съответното подменю.

(Опции: off (Изкл.), 30 минути, 60 минути, 90 минути, 120 минути, 150 минути, 180 минути, 210 минути, 240 минути)

Auto Sleep (Автоматично заспиване) – Използвайте бутоните ▲/▼, за да изберете опцията, и след това натиснете **OK**, за да отворите съответното подменю.

(Опции: Никога, 4 часа, 6 часа, 8 часа)

ТАЙМЕР

Menu -> Settings -> System -> Power & Energy -> Timer (Меню -> Настройки -> Система -> Захранване и енергия -> Таймер).

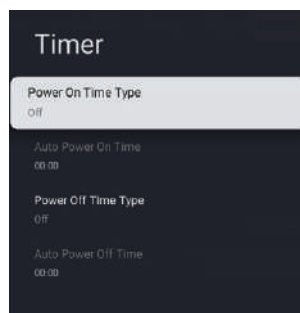

Power On Time Type (Тип таймер за включване) – Използвайте бутоните ▲/▼, за да изберете опцията, и след това натиснете **OK**, за да изберете опция OFF / ON / ONCE (ВКЛ. / ИЗКЛ. / Еднократен).

Auto Power On Time (Време за автоматично включване) – Използвайте бутоните ▲/▼, за да изберете опцията, и след това натиснете **OK**, за да отворите съответното подменю.

Power Off Time Type (Тип таймер за изключване) – Използвайте бутоните ▲/▼, за да изберете опцията, и след това натиснете **OK**, за да изберете опция OFF / ON / ONCE (ВКЛ. / ИЗКЛ. / Еднократен).

Auto Power Off Time (Време за автоматично изключване) – Използвайте бутоните ▲/▼, за да изберете опцията, и след това натиснете **OK**, за да отворите съответното подменю.

ИЗЛЪЧВАНЕ

Menu -> Settings -> System -> Cast (Меню -> Настройки -> Система -> Излъчване).

ИНСТРУКЦИИ ЗА РАБОТА

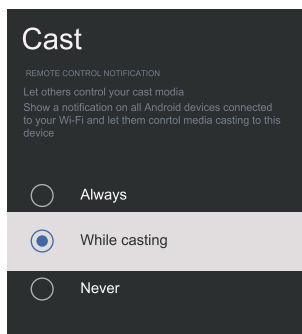

1. Използвайте бутоните ▲/▼, за да изберете настройката, която искате да промените.
2. Натиснете бутона **OK**, за да потвърдите.
3. Натиснете бутона **BACK** (Връщане назад), за да се върнете към предишното меню.

ТЪРГОВСКИ РЕЖИМ

Menu -> Settings -> System -> Retail Mode (Меню -> Настройки -> Система -> Търговски режим).

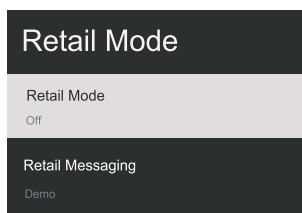

Retail Mode (Търговски режим) – Използвайте бутоните ▲/▼, за да изберете опцията, и след това натиснете **OK**, за да изберете ВКЛ./ИЗКЛ.
Retail Messaging (Търговски съобщения) – Използвайте бутоните ▲/▼, за да изберете опцията, и след това натиснете **OK**, за да отворите съответното подменю. (Забележка: Demo (Демонстрация), e-POP, e-POP+ Demo (e-POP + Демонстрация))

РЕСТАРТИРАНЕ

Menu -> Settings -> System -> Restart (Меню -> Настройки -> Система -> Рестартиране).
Натиснете бутона **OK**, за да отворите подменюто. (Опции: Restart (Рестартиране) и Cancel (Отмяна))

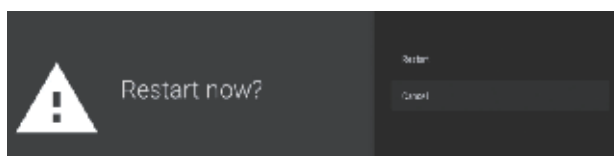

ДИСТАНЦИОННИ УПРАВЛЕНИЯ И ПРИНАДЛЕЖНОСТИ

Menu -> Settings -> Remotes & Accessories (Меню -> Настройки -> Дистанционни управления и принадлежности).

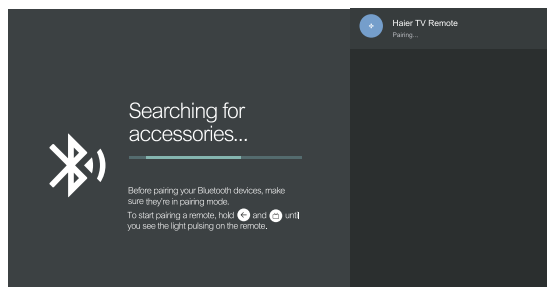
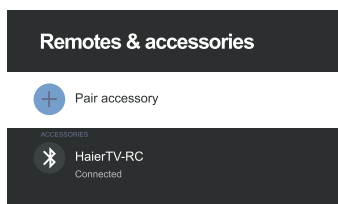

В това меню можете да сдвоявате Bluetooth устройства.

1. Натиснете едновременно и задръжте за 5 секунди бутоните ← и 📺 в долната част на дистанционното управление.
2. Когато LED индикаторът започне да мига, освободете бутоните. Дистанционното управление ще изпрати сигнал за сдвояване към телевизора и информацията на дистанционното управление ще се покаже от дясната страна на екрана.
3. Натиснете бутона **OK**, за да изведете състоянието на сдвояване. Ако се покаже сдвояване, свързването е успешно.
4. Ако се покаже съобщение, че не може да бъде осъществено сдвояване, свързването е неуспешно. Изчакайте 30 секунди и след това натиснете едновременно и задръжте за 5 секунди бутоните ← и 📺 в долната част на дистанционното управление, за да повторите предишните стъпки.
5. Натиснете бутона ←, за да се върнете към предишното меню.

ИЗПОЛЗВАНЕ НА МУЛТИМЕДИЙНИЯ ПЛЕЙЪР

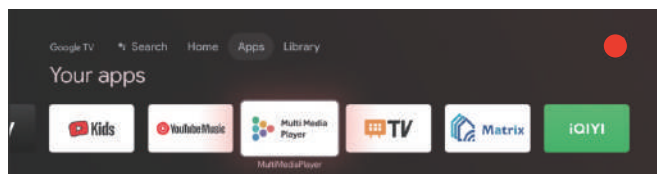

1. В началната страница **HOME** или в страницата **APPS** (Приложения) **използвайте бутоните ▲/▼/◀/▶**, за да изберете приложението **Multi Media Player** (Мултимедийен плейър)

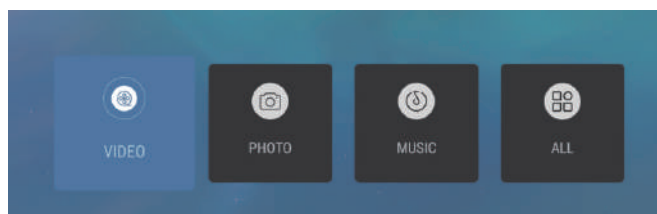

2. Натиснете бутона **OK**, за да отворите мултимедийния плейър и да пуснете Video (Видео), Photo (Снимки), Audio (Аудио). След като поставите USB памет, можете да разглеждате файловете в паметта (Формат FAT32).

ЗАБЕЛЕЖКА

Менюто може да се различава в зависимост от периода, в който сте закупили телевизора.

ОТСТРАНЯВАНЕ НА НЕИЗПРАВНОСТИ

Преди да се обадите на центъра за обслужване, направете тези лесни проверки. Тези съвети могат да Ви спестят време и пари, тъй като таксите за инсталация на телевизора и извършване на потребителски настройки не се покриват от гаранцията.

Симптоми	Елементи за проверка и необходими действия
„Фантомно“ или двойно изображение	<ul style="list-style-type: none"> Причината може да е наличие на смущения в антената поради високи сгради или хълмове. Картината може да се подобри чрез чувствителна насочена антена.
Няма захранване	<ul style="list-style-type: none"> Проверете дали захранващият кабел за променлив ток на телевизора е включен в контакта. Изключете телевизора и изчакайте 60 секунди. След това включете отново щепсела в контакта и включете телевизора.
Няма картина	<ul style="list-style-type: none"> Проверете дали антената е правилно свързана към гнездото от задната страна на телевизора. Вероятни проблеми в излъчването от съответната станция. Опитайте друг канал. Регулирайте настройките за контраст и яркост. Проверете настройката Closed Captions (Скрити надписи). Някои режими за текст може да блокират екрана.
Картината е добра, но няма звук	<ul style="list-style-type: none"> Натиснете бутона MUTE (Изключване на звука) на дистанционното управление, за да се уверите, че звукът не е изключен.
Звукът е добър, но цветовете не изглеждат добре	<ul style="list-style-type: none"> Регулирайте настройките за контраст, цвят и яркост.
Лошо качество на картината	<ul style="list-style-type: none"> Качеството на картината може да се влоши при свързване на S-VHS камера или видеокамера едновременно с други периферни устройства към телевизора. Изключете някое от периферните устройства.
Снежинки и шум в картината	<ul style="list-style-type: none"> Проверете свързването на антената.
Хоризонтална пунктирана линия	<ul style="list-style-type: none"> Това може да се дължи електрически смущения (напр. от сешоар, неонов лампи наблизо и др.). Изключете съответния уред.
Телевизорът не реагира на дистанционното управление	<ul style="list-style-type: none"> Проверете дали батериите работят. Сменете ги, ако е необходимо. Почистете лещата на сензора за дистанционно управление на телевизора.
Пиксели (точки), които винаги остават тъмни или светли	<ul style="list-style-type: none"> Телевизорът е произведен по прецизна технология от изключително високо ниво. Въпреки това, понякога може да има пиксели, които не се показват правилно. Това не е необичайно за подобни устройства и не представлява дефект.

ЗАБЕЛЕЖКА

- Устройството използва панел, който се състои от подчинени пиксели, които изискват усъвършенствана технология за генериране. Въпреки това, е възможно на екрана да се появяват някои ярки или тъмни пиксели. Тези пиксели не оказват влияние върху работата на устройството.



Термините HDMI, HDMI High-Definition Multimedia Interface, търговските опаковки на HDMI и логата на HDMI са търговски марки или регистрирани търговски марки на HDMI Licensing Administrator, Inc.



Dolby, Dolby Vision, Dolby Atmos, Dolby Audio и символът двойно D са търговски марки на Dolby Laboratories Licensing Corporation. Произведено по лиценз на Dolby Laboratories. Поверителни непубликувани работи. Copyright ©2012-2024 Dolby Laboratories. Всички права запазени.

СПЕЦИФИКАЦИИ НА ПРОДУКТА

43" UHD LED TV

Качество на телевизионната картина:	UHD Интегрирана цифрова технология. Размер на екрана: 108 cm Резолюция 3840x2160 пиксела, 60Hz.
Телевизионна система:	PAL-B/G, SECAM-B/G
DTV тунер декодер	DVB-T, DVB-C, DVB-T2, DVB-S2 16/32/64/128/256 QAM модулация MPEG2, MPEG4, H.265
Свързаност:	1 порт за оптичен кабел 2 USB порта 1 порт LAN 4 гнезда HDMI 1 гнездо VIDEO 1 гнездо L 1 гнездо R 2 гнезда RF 1 порт за слушалки 1 слот за CI карта Поддържани системи: PAL+ SECAM Брой канали: 1000 (DTV), 100 (ATV) TV (RF): 75 Ω импеданс AV видео вход: 75 Ω, 1V-P, RCA AV аудио вход: 20K Ω, 500 mV RMS HDMI видео вход: 480i, 480p, 720p, 1080i, 1080p, 2160p WiFi: Стандарт: IEEE 802.11a/b/g/n/ac, Честота: 2,4 GHz / 5 GHz Bluetooth: V5.1
Качество на звука:	Стерео аудио система. Изходна мощност 2 x 10 W RMS.
Консумирана мощност в режим на готовност	≤ 0,5 W
Дигитални функции:	Дигитален интерактивен интерфейс. Дигитален текст. Дигитално излъчване на видео (DVB) със субтитри. Автоматична настройка. Автоматично сканиране за нови канали. Справочник за текущи и следващи програми. 7-дневен електронен справочник на програмите (EPG). Слот за CI карта. Съвместимост с аудио описание.
Допълнителни функции:	UHF/VHF тунер; Таймер за заспиване; Родителски контрол; Картина и текст Батерии на дистанционното управление: 2 бр. тип AAA. Монтажен размер VESA: 300 x 300 mm Размер на опаковката (ШxВxД): 1075 x 652 x 142 mm Размер в инсталирано състояние (ШxВxД) със стойка: 957,2 x 607,4 x 240,7 mm Размер в инсталирано състояние (ШxВxД) без стойка: 957,2 x 566,7 x 86,6 mm Тегло на пакета: 10 kg Нето тегло със стойка: 7,2 kg Нето тегло без стойка: 6,8 kg

* Част от спецификациите на този телевизор са посочени тук само за справка. Възможни са разлики поради актуализиране на технологията на продукта. Дизайнът и спецификациите са предмет на промяна без предизвестие.

СПЕЦИФИКАЦИИ НА ПРОДУКТА

50" UHD LED TV

Качество на телевизионната картина:	UHD Интегрирана цифрова технология. Размер на екрана: 126 cm Резолюция 3840x2160 пиксела, 60Hz.
Телевизионна система:	PAL-B/G, SECAM-B/G
DTV тунер декодер	DVB-T, DVB-C, DVB-T2, DVB-S2 16/32/64/128/256 QAM модуляция MPEG2, MPEG4, H.265
Свързаност:	1 порт за оптичен кабел 2 USB порта 1 порт LAN 4 гнезда HDMI 1 гнездо VIDEO 1 гнездо L 1 гнездо R 2 гнезда RF 1 порт за слушалки 1 слот за CI карта Поддържани системи: PAL+ SECAM Брой канали: 1000 (DTV), 100 (ATV) TV (RF): 75 Ω импеданс AV видео вход: 75 Ω, 1V-P, RCA AV аудио вход: 20K Ω, 500 mV RMS HDMI видео вход: 480i, 480p, 720p, 1080i, 1080p, 2160p WiFi: Стандарт: IEEE 802.11a/b/g/n/ac, Честота: 2,4 GHz / 5 GHz Bluetooth: V5.1
Качество на звука:	Стерео аудио система. Изходна мощност 2 x 13.5 W RMS.
Консумирана мощност в режим на готовност	≤ 0,5 W
Дигитални функции:	Дигитален интерактивен интерфейс. Дигитален текст. Дигитално излъчване на видео (DVB) със субтитри. Автоматична настройка. Автоматично сканиране за нови канали. Справочник за текущи и следващи програми. 7-дневен електронен справочник на програмите (EPG). Слот за CI карта. Съвместимост с аудио описание.
Допълнителни функции:	UHF/VHF тунер; Таймер за заспиване; Родителски контрол; Картина и текст Батерии на дистанционното управление: 2 бр. тип AAA. Монтажен размер VESA: 300 x 300 mm Размер на опаковката (ШxВxД): 1250 x 760 x 144 mm Размер в инсталирано състояние (ШxВxД) със стойка: 1111,2 x 710,5 x 277,2 mm Размер в инсталирано състояние (ШxВxД) без стойка: 1111,2 x 651,8 x 88 mm Тегло на пакета: 13,5 kg Нето тегло със стойка: 10 kg Нето тегло без стойка: 9,5 kg

* Част от спецификациите на този телевизор са посочени тук само за справка. Възможни са разлики поради актуализиране на технологията на продукта. Дизайнът и спецификациите са предмет на промяна без предизвестие.

СПЕЦИФИКАЦИИ НА ПРОДУКТА

55" UHD LED TV

Качество на телевизионната картина:	UHD Интегрирана цифрова технология. Размер на екрана: 139 cm Резолюция 3840x2160 пиксела, 60Hz.
Телевизионна система:	PAL-B/G, SECAM-B/G
DTV тунер декодер	DVB-T, DVB-C, DVB-T2, DVB-S2 16/32/64/128/256 QAM модулация MPEG2, MPEG4, H.265
Свързаност:	1 порт за оптичен кабел 2 USB порта 1 порт LAN 4 гнезда HDMI 1 гнездо VIDEO 1 гнездо L 1 гнездо R 2 гнезда RF 1 порт за слушалки 1 слот за CI карта Поддържани системи: PAL+ SECAM Брой канали: 1000 (DTV), 100 (ATV) TV (RF): 75 Ω импеданс AV видео вход: 75 Ω, 1V-P, RCA AV аудио вход: 20K Ω, 500 mV RMS HDMI видео вход: 480i, 480p, 720p, 1080i, 1080p, 2160p WiFi: Стандарт: IEEE 802.11a/b/g/n/ac, Честота: 2,4 GHz / 5 GHz Bluetooth: V5.1
Качество на звука:	Стерео аудио система. Изходна мощност 2 x 13,5 W RMS.
Консумирана мощност в режим на готовност	≤ 0,5 W
Дигитални функции:	Дигитален интерактивен интерфейс. Дигитален текст. Дигитално излъчване на видео (DVB) със субтитри. Автоматична настройка. Автоматично сканиране за нови канали. Справочник за текущи и следващи програми. 7-дневен електронен справочник на програмите (EPG). Слот за CI карта. Съвместимост с аудио описание.
Допълнителни функции:	UHF/VHF тунер; Таймер за заспиване; Родителски контрол; Картина и текст Батерии на дистанционното управление: 2 бр. тип AAA. Монтажен размер VESA: 300 x 300 mm Размер на опаковката (ШxВxД): 1350 x 837 x 144 mm Размер в инсталирано състояние (ШxВxД) със стойка: 1225,8 x 777,3 x 277,2 mm Размер в инсталирано състояние (ШxВxД) без стойка: 1225,8 x 719,4 x 88,1 mm Тегло на пакета: 16,4 kg Нето тегло със стойка: 11,9 kg Нето тегло без стойка: 11,4 kg

* Част от спецификациите на този телевизор са посочени тук само за справка. Възможни са разлики поради актуализиране на технологията на продукта. Дизайнът и спецификациите са предмет на промяна без предизвестие.

СПЕЦИФИКАЦИИ НА ПРОДУКТА

65" UHD LED TV

Качество на телевизионната картина:	UHD Интегрирана цифрова технология. Размер на екрана: 164 cm Резолюция 3840x2160 пиксела, 60Hz.
Телевизионна система:	PAL-B/G, SECAM-B/G
DTV тунер декодер	DVB-T, DVB-C, DVB-T2, DVB-S2 16/32/64/128/256 QAM модулация MPEG2, MPEG4, H.265
Свързаност:	1 порт за оптичен кабел 2 USB порта 1 порт LAN 4 гнезда HDMI 1 гнездо VIDEO 1 гнездо L 1 гнездо R 2 гнезда RF 1 порт за слушалки 1 слот за CI карта Поддържани системи: PAL+ SECAM Брой канали: 1000 (DTV), 100 (ATV) TV (RF): 75 Ω импеданс AV видео вход: 75 Ω, 1V-P, RCA AV аудио вход: 20K Ω, 500 mV RMS HDMI видео вход: 480i, 480p, 720p, 1080i, 1080p, 2160p WiFi: Стандарт: IEEE 802.11a/b/g/n/ac, Честота: 2,4 GHz / 5 GHz Bluetooth: V5.1
Качество на звука:	Стерео аудио система. Изходна мощност 2 x 13,5 W RMS.
Консумирана мощност в режим на готовност	≤ 0,5 W
Дигитални функции:	Дигитален интерактивен интерфейс. Дигитален текст. Дигитално излъчване на видео (DVB) със субтитри. Автоматична настройка. Автоматично сканиране за нови канали. Справочник за текущи и следващи програми. 7-дневен електронен справочник на програмите (EPG). Слот за CI карта. Съвместимост с аудио описание.
Допълнителни функции:	UHF/VHF тунер; Таймер за заспиване; Родителски контрол; Картина и текст Батерии на дистанционното управление: 2 бр. тип AAA. Монтажен размер VESA: 400 x 300 mm Размер на опаковката (ШxВxД): 1600 x 960 x 164 mm Размер в инсталирано състояние (ШxВxД) със стойка: 1446,4 x 904,7 x 313,8 mm Размер в инсталирано състояние (ШxВxД) без стойка: 1446,4 x 841,3 x 85,1 mm Тегло на пакета: 24 kg Нето тегло със стойка: 17,2 kg Нето тегло без стойка: 16,5 kg

* Част от спецификациите на този телевизор са посочени тук само за справка. Възможни са разлики поради актуализиране на технологията на продукта. Дизайнът и спецификациите са предмет на промяна без предизвестие.

Haier

Haier

Inspiration til dit liv

Brugervejledning

MODELLER:

H43Q80FUX

H50Q80FUX

H55Q80FUX

H65Q80FUX



Illustrationerne i denne vejledning er udelukkende vejledende og kan afvige fra det faktiske produkt. Ret til uvarslet ændring i design og specifikationer forbeholdes.

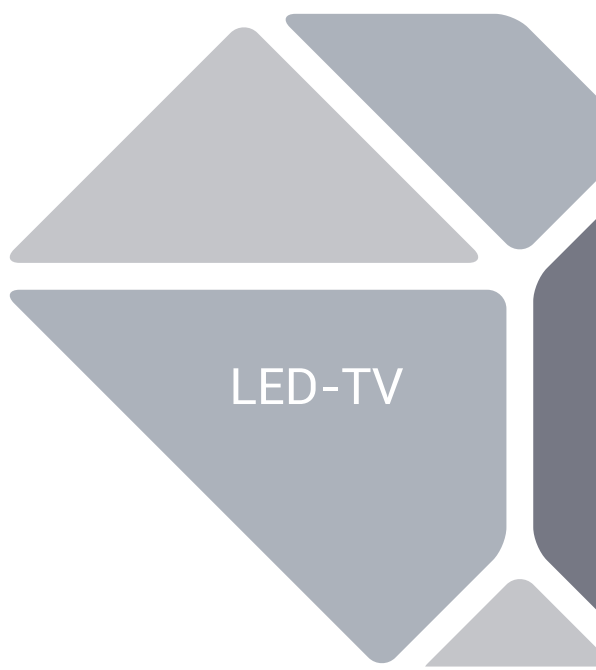

INDHOLDSFORTEGNELSE

1. VIGTIGE SIKKERHEDSINSTRUKTIONER	1
2. KLARGØRING	3
3. TILSLUTNING AF EKSTERNT UDSTYR OG BETJENINGSKNAPPER.....	4
4. SÅDAN FORETAGES TILSLUTNINGER	5
5. BRUGERVEJLEDNING	6
6. FEJLFINDING.....	19
7. PRODUKTSPECIFIKATIONER.....	20



Illustrationerne i denne vejledning er udelukkende vejledende og kan afvige fra det faktiske produkt. Ret til uvarslet ændring i design og specifikationer forbeholdes.

VIGTIGE SIKKERHEDSINSTRUKTIONER

- 1) Læs denne vejledning.
- 2) Gem denne vejledning.
- 3) Vær opmærksom på advarslerne.
- 4) Følg alle anvisninger.
- 5) Apparatet bør ikke anvendes nær vand.
- 6) Apparatet må kun rengøres med en tør klud.
- 7) Undlad at blokere apparatets ventilationsåbninger. Installér apparatet iht. vejledningen.
- 8) Må ikke placeres nær varmekilder som f.eks. radiatorer, varmeapparater, ovne eller andre apparater (inkl. forstærkere), der afgiver varme.
- 9) Fjern eller tilsidesæt ikke sikringen på det polariserede stik. Hvis det medfølgende stik ikke passer i stikkontakten, skal du kontakte en elektriker for at få udskiftet den forældede stikkontakt.
- 10) Sørg for, at netledningen ikke bliver trådt på eller klemt, især ved diverse stik og sammenføjringer samt der, hvor ledningerne kommer ud af apparatet.
- 11) Brug kun udstyr/tilbehør, der er specificeret af producenten.
- 12) Tag apparatets stik ud af stikkontakten i tordenvejr, eller når det ikke bruges i længere perioder.
- 13) Al service skal udføres af autoriseret servicepersonale. Service er påkrævet, hvis apparatet beskadiges på nogen måde. Det kan fx være, at strømforsyningskablet eller stikket er beskadiget, der er spildt væske eller tabt genstande ned i apparatet, at apparatet har været udsat for regn eller fugt, at det ikke fungerer normalt eller er blevet tabt.
- 14) Stikproppen fungerer som frakoblingsenhed, og der skal altid være let adgang til denne.
- 15) Ventilationen må ikke forhindres ved at tildække ventilationsåbningerne med genstande som aviser, duge, gardiner osv.
- 16) Placér ikke kilder med åben ild, såsom et tændt stearinlys, oven på apparatet.
- 17) Tænk på miljøet ved bortskaffelse af brugte batterier.
- 18) Apparatet er beregnet til brug under moderate klimaforhold.
- 19) Apparatet må ikke udsættes for dryp eller stænk og ingen genstande med vand, som vaser, må placeres på apparatet.
- 20) Advarsel: Undgå skader forårsaget af, at produktet tipper og falder ned, ved altid at sikre, at produktet i sin helhed er placeret indenfor bordet og står vandret.

*** Det faktiske produkt kan afvige i udseende fra ovenstående billede***

Hvis stikproppen fungerer som frakoblingsenhed, skal installationsvejledningen angive, at den stikkontakt, apparatet er tilsluttet, skal være let tilgængelig.

	FORSIGTIG RISIKO FOR ELEKTRISK STØD MÅ IKKE ÅBNES!	
FORSIGTIG NEDSÆT RISIKOEN FOR ELEKTRISK STØD VED ALDRIG AT FJERNE DÆKSLER (ELLER BAGKLÆDNING). APPARATET INDEHOLDER INGEN DELE, BRUGER SELV KAN SERVICERE. OVERLAD AL SERVICE TIL KVALIFICERET FAGMAND.		



Symbolet angiver, at apparatet indeholder farlig spænding, der kan udgøre en risiko for elektrisk stød.



Symbolet angiver, at der findes vigtige oplysninger vedr. betjening og vedligeholdelse i den medfølgende vejledning.

ADVARSEL:

Nedsæt risikoen for brand eller elektrisk stød ved aldrig at udsætte dette apparat for regn eller fugt.

ADVARSEL:

Batterierne må ikke udsættes for stærk varme som fx direkte sol, ild eller lignende.



Dette symbol angiver, at produktet indeholder dobbeltisolering mellem farlig spænding og brugertilgængelige dele. Under service må der kun anvendes originale reservedele.



Denne markering angiver, at produktet ikke må bortskaffes med det almindelige husholdningsaffald. Undgå mulig skade på miljøet eller menneskers sundhed fra ukontrolleret affaldsbortskaffelse ved at genbruge produktet på ansvarlig vis for at fremme bæredygtig genbrug af materielle ressourcer. Når du vil returnere din brugte enhed, skal du bruge retur- og afhentningssystemet eller kontakte forhandleren, hvor produktet er købt. De kan sørge for miljøsikker genanvendelse af produktet.

VIGTIGE SIKKERHEDSINSTRUKTIONER

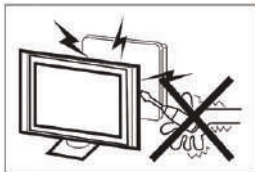

Der anvendes høj spænding ved driften af denne TV-modtager. Fjern aldrig bagklædningen fra dette TV. Overlad al service til kvalificeret fagmand.

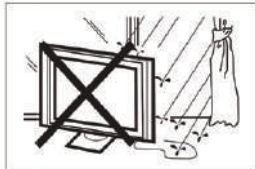

Undgå brand eller elektrisk stød ved aldrig at udsætte dette TV for regn eller fugt.



Undlad at tabe eller skubbe genstande ind i TV'et gennem sprækker og åbninger. Undlad at spilde væske af nogen art på TV'et.



Undlad at blokere ventilationsåbningerne på bagdækslet. Tilstrækkelig ventilation er nødvendig for at forhindre funktionssvigt i de elektriske komponenter.



Lad ikke ledningen være i klemme under TV'et.



Tag stikket ud af stikkontakten inden rengøring, og rengør TV'et med en blød stofklud. Brug ikke vand og aldrig kemikalier.

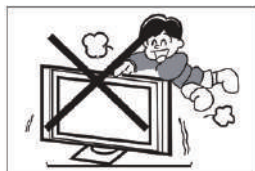

Undlad at stå på, læne dig op ad eller pludselig skubbe til TV'et eller dets fod. Vær især opmærksom på børn. Risiko for alvorlig skade, hvis TV'et falder ned.

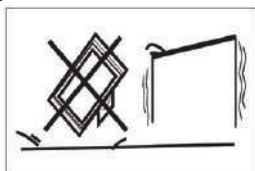

Undlad at placere dit TV på et ustabilt rullebord, fod, hylde eller bord. Hvis TV'et falder ned, kan det medføre alvorlig personskade eller beskadige TV'et.

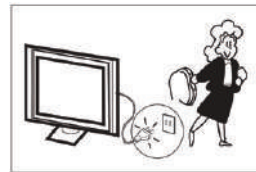

Hvis TV'et ikke skal bruges i længere tid, anbefales det at tage stikket ud af stikkontakten.



Udsæt ikke TV'et for direkte sollys eller andre varmekilder. Stil ikke TV'et direkte ovenpå andre produkter, der afgiver varme, fx en videoafspiller eller forstærker. Undlad at placere åben ild, som fx stearinlys, ovenpå TV'et.

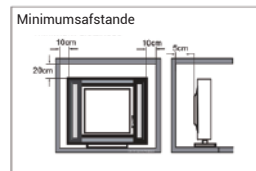

Hvis TV'et skal indbygges i et skab eller andet indelukke, skal minimumsafstandene overholdes. Varmeophobning kan nedsætte TV'ets levetid, ligesom det kan være farligt. Bemærk: Apparatet er beregnet til brug under moderate klimaforhold.

Forsigtig:

Et TV kan falde ned og forårsage alvorlig personskade eller død. Mange skader, især hos børn, kan undgås ved at tage enkle forholdsregler som:

- Brug **ALTID** skabe eller borde eller monteringsmetoder anbefalet af producenten af TV'et.
- Brug **ALTID** møbler, der sikkert kan bære vægten af TV'et.
- Sørg **ALTID** for, at TV'et ikke stikker ud over kanten af det møbel, det står på.
- Oplys **ALTID** børn om faren ved at klatre op på møblerne for at nå TV'et og dets knapper.
- Placér **ALTID** TV'ets kabler og ledninger på en sådan måde, at de ikke kan udgøre en snublefare, blive trukket i eller grebet fat i.
- Placér aldrig et TV på et ustabilt underlag.
- Placér **ALDRIG** TV'et på et højt møbel (fx skabe eller reoler) uden at fastgøre både møblet og TV'et sikkert, så det står stabilt.
- Placér **ALDRIG** TV'et på en dug eller andet materiale, som befinder sig mellem TV'et og det møbel, der bærer det.
- Placér **ALDRIG** genstande, der kan friste børn til at klatre op, som fx legetøj og fjernbetjening, ovenpå TV'et eller det møbel, TV'et er placeret på.

Hvis TV'et skal flyttes til et nyt sted, skal samme overvejelser anvendes på det nye sted.

KLARGØRING

VIGTIGT: Undlad at trykke mod skærmen, da dette kan kompromittere skærmens integritet. Producentens garanti dækker ikke misligholdelse eller fejlagtig installation.

MONTERING AF FODEN

VIGTIGT: Foden skal monteres på TV'et inden ibrugtagning.

1. Placér TV'et med skærmen nedad på et blødt underlag (tæppe, skumgummi, stof osv.) for at undgå skader på TV'et.
2. Fastgør foden i bunden af TV'et med de 6 skruer.

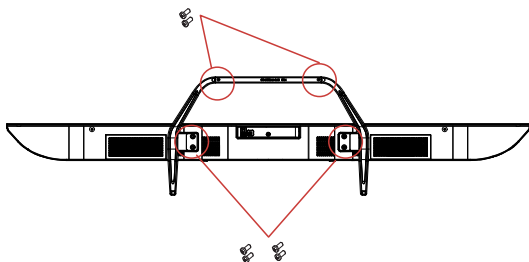

! BEMÆRK
Produktets udseende er vejledende.

KLARGØRING AF LED TV'ET TIL VÆGMONTERING

Vi anbefaler, at du holder en afstand på mindst 60 mm fra væggen for at undgå interferens fra kabler. Tag foden af TV'et, inden du vægmonterer det.

Af hensyn til din sikkerhed bør du udelukkende anvende et UL-listet vægbeslag, der som minimum kan bære vægten af TV'et uden fod.

Sådan monteres vægbeslaget på TV'et:

1. Fjern de skruer, der holder TV'et fast på foden.
2. Tag foden af TV'et.
3. Fastgør vægbeslaget på bagsiden af TV'et med fire skruer. Følg den vejledning, der fulgte med vægbeslaget, for at færdiggøre installationen.

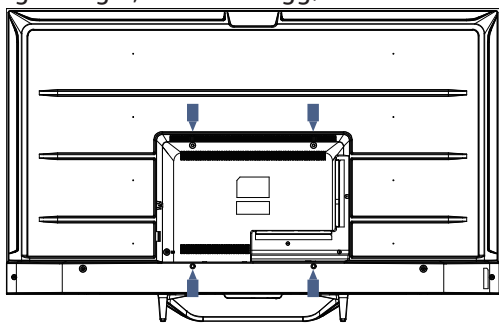

! BEMÆRK
Vægbeslag medfølger ikke.

4. Fastgør vægbeslaget med skruer (M6 x 12 mm/4 stk.) på bagsiden af LED TV'et med et moment på 12 kgf-cm.

TÆND FOR TV'ET

1. Sæt foden på, og placér TV'et på et fast underlag.

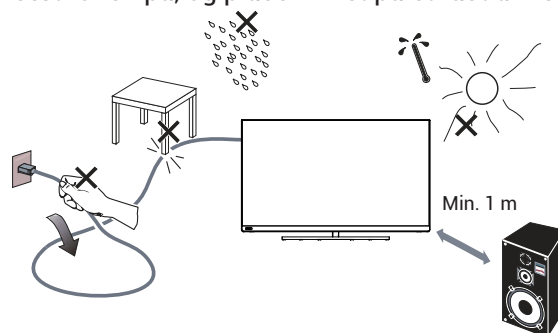

BEMÆRK

- Kontrollér, at TV'et er placeret på en sådan måde, at ventilation kan finde sted. Undlad at tildække ventilationsåbningerne på bagpanelet.
 - For at undgå farlige situationer må der ikke placeres åben ild i form af fx tændte stearinlys på eller nær apparatet.
 - Undgå at udsætte apparatet for varme, direkte sollys, regn eller vand. Apparatet må ikke udsættes for dryp eller stænk.
2. Slut antennekablet eller kablet til kabel-TV til antennestikket **ANT IN** på bagsiden af TV'et.
 3. Fjernbetjening:
Tag dækslet af batterirummet. Læg 2 batterier i (type AAA 1,5 V).

FORSIGTIG: Risiko for brand eller eksplosion, hvis batterierne erstattes med en forkert type.

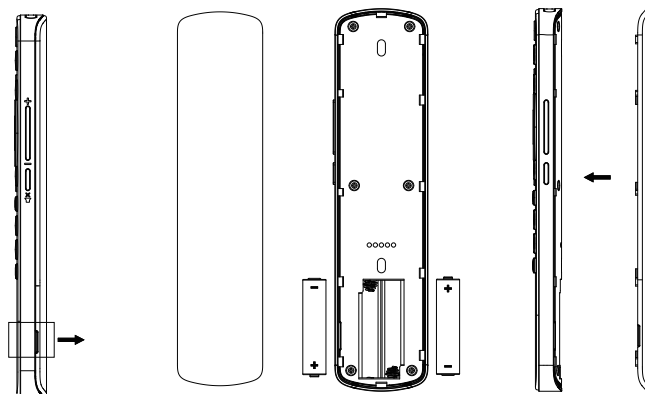

4. Strøm:
Slut stikproppen til en fungerende stikkontakt.

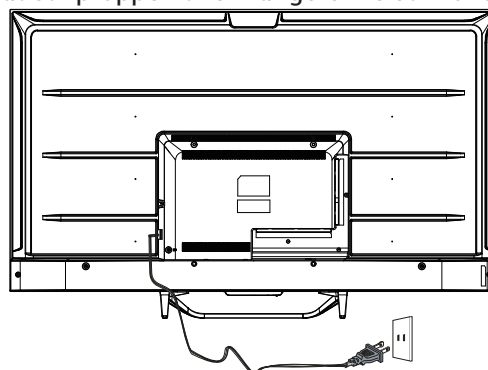

5. Tænd TV'et:
Tryk på knappen  på fjernbetjeningen eller på knappen **POWER** på TV'ets sidepanel.

TILSLUTNING AF EKSTERNT UDSTYR OG BETJENINGSKNAPPER

BETJENINGSKNAPPER

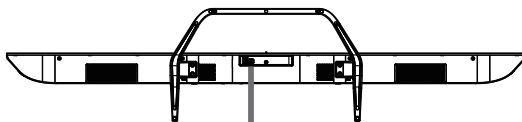
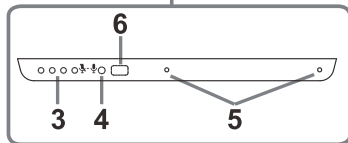
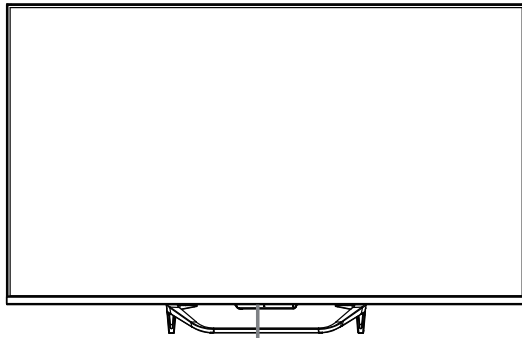

1 2

1. Tænd/sluk
2. Stemmestyring til / Stemmestyring fra
🗨 Aktivér fjernassistent
🗨 Deaktivér fjernassistent

Drej til højre for at slå funktionen til. Kontrollampen tænder og slukker, og stemmestyringsfunktionen er blevet aktiveret. Du kan sige "Ok Google" for at bruge stemmefunktionen, og kontrollampen lyser, når TV'et modtager talekommandoen. Indtal herefter din anmodning.

Drej til venstre for at slå funktionen fra. Kontrollampen skifter til gult.

3. Kontrollampe til fjernassistent
4. Signalmotager til fjernbetjening
5. Modtager til stemmestyring
6. LED-kontrollampe



BEMÆRK

Sørg for, at TV'et er forbundet til internettet, før du anvender Stemmestyring.

Slå funktionen til, før du anvender Stemmestyring.

Log ind på din GOOGLE-konto, før du anvender Stemmestyring.

MEDFØLGENDE TILBEHØR

Fjernbetjening - 1 stk.
Brugervejledning - 1 stk.
Skruer - 6 stk.
Startvejledning - 1 stk.
Garantibevis - 1 stk.

EKSTERNE TILSLUTNINGER



Alle terminaler er (fra venstre mod højre):
LAN, OPTISK, VIDEO, L, R, HDMI4, HDMI3, HDMI2,



Alle terminaler er (fra venstre mod højre):
HDMI1 (eARC/ARC), LNB IN (SATELLIT), ANT IN (ANTENNE/KABEL), USB1, USB2, ØRETELEFONER, CI.

SÅDAN FORETAGES TILSLUTNINGER

AV-UDSTYR

Dette TV er udstyret med en gruppe AV-terminaler, hvor du let kan tilslutte VCR, DVD eller andet videoudstyr. Se desuden brugervejledningen til det udstyr, du vil tilslutte. Du kan anvende indgangsterminalerne på TV'ets bagside som følger.

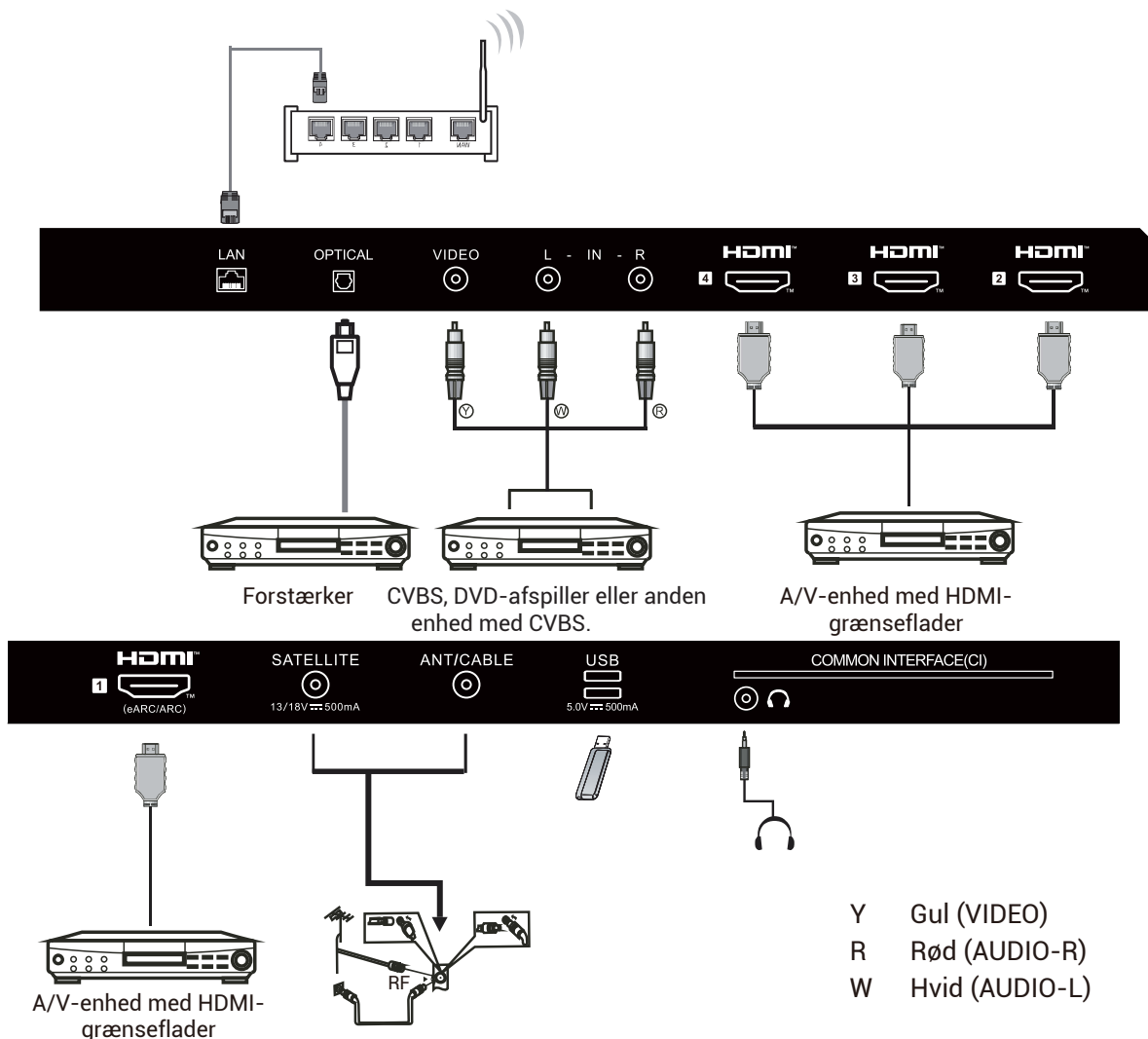

Det kan forbindes til følgende enheder: VCR, multidiskafspiller, DVD, camcorder, videospil, stereosystem osv...

Bemærk:

I visse tilfælde understøttes dette ikke på andre enheder, da enheden leverer ikke-standardsignal.

BRUGERVEJLEDNING

BRUG AF FJERNBETJENINGEN



#	Punkt	Beskrivelse
1	Strøm	Tryk for at tænde eller slukke TV'et. Når TV'et er slukket, bruger det stadig en smule strøm. Hvis du vil koble enheden helt fra lysnettet, skal du tage stikket ud.
2		Tryk for at åbne MAGIC BOARD.
3		Tryk for at åbne eller lukke skærmmenuen.
4		Tryk for konto og indlogging på Google TV. (Ved opsætning af et almindeligt TV har denne knap ingen funktion)
5		Tryk for at navigere i skærmmenuen.
6		Gå tilbage til forrige menu.
7		Tryk for at åbne startside.
8		Tryk for at skifte TV-kanal.
9		Tryk for at gå til prime video og se TV-shows og film online (internetforbindelse påkrævet).
10		Tryk for at åbne Live TV.
11		Tryk for at åbne YouTube Musik.
12		Tryk for at åbne NETFLIX.
13		Tryk for at åbne Multimediaefspiller.
14		Tryk for at åbne Google Assistant eller starte stemmestyrret søgning.
15		Tryk for at åbne menuen indstillinger.
16	VOL+/ VOL-	Tryk på VOL+ eller VOL- for at indstille lydstyrken.
17	OK	Indtast dit valg, eller udfør den valgte handling.
18		Tryk for at slå lyden til eller fra.
19		Tryk for at åbne den elektroniske programguide i TV-tilstand.
20		Tryk for at skifte TV-kanal.
21		Tryk for at åbne listen med signalkilder.
22		Tryk for at afspille/sætte på pause i multimedietilstand.
23	AUDIO	Tryk for at skifte lydspor.
24		Tryk for at åbne apps.
25		Tryk for at åbne YouTube.

BRUGERVEJLEDNING

FØRSTE KONFIGURATION

Første gang, du tænder dit TV, vises opsætningsguiden, der hjælper dig med at foretage de grundlæggende indstillinger.

Følg vejledningen på skærmen for at foretage førstegangsopsætningen.

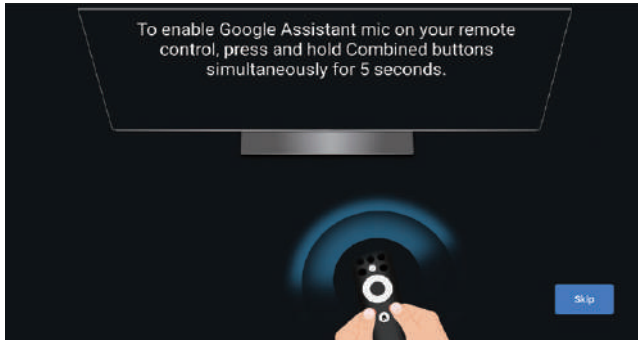

Denne funktion anvendes til fjernbetjeningens parringskode. Når koden er registreret, kan du anvende Bluetooth-fjernbetjeningen til betjening af TV'et.

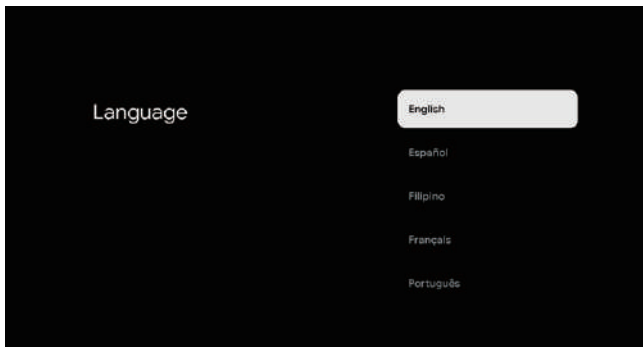

Tryk på knapperne ▲/▼ for at vælge sprog til systemet, og tryk på knappen **OK** for at bekræfte sproget.

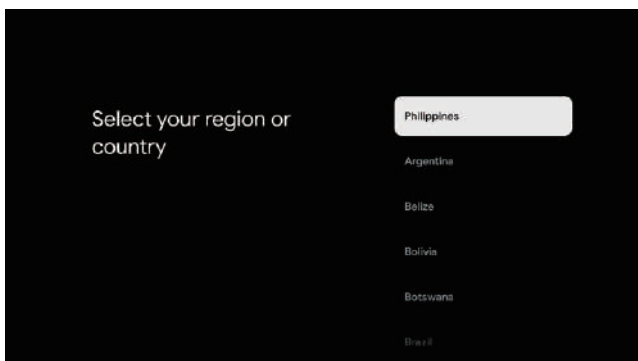

Tryk på knapperne ▲/▼ for at vælge region/land til din enhed, og tryk på knappen **OK** for at bekræfte.

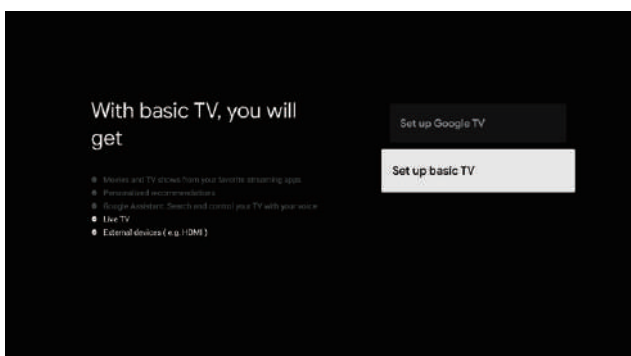

Tryk på knapperne ▲/▼, vælg "Set up basic TV" (Grundlæggende opsætning af TV) for din enhed, og tryk på knappen **OK** for at færdiggøre opsætningen.

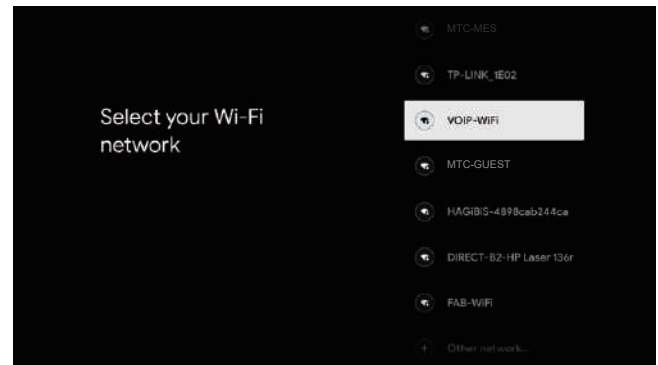

Tryk på knapperne ▲/▼ for at vælge det wi-fi-netværk, du vil oprette forbindelse til, tryk på knappen **OK**, og indtast adgangskoden for at bekræfte tilslutningen.

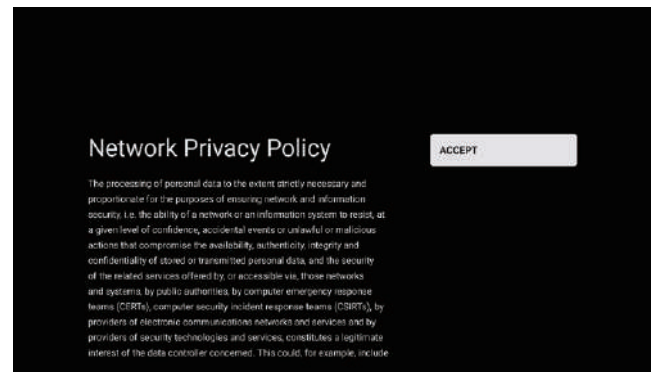

Vælg "Accept" (OK) for at acceptere betingelserne for netværkets privatlivspolitik.

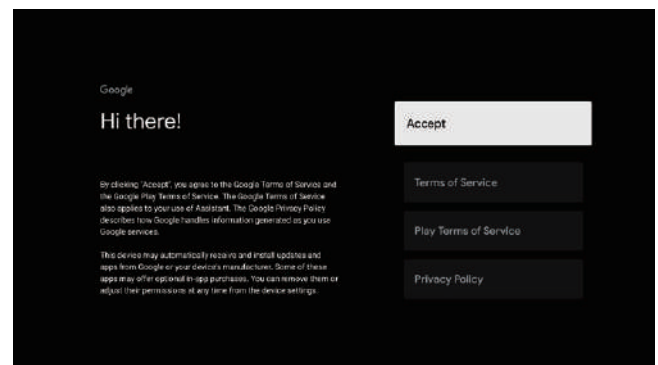

Hvis du vil acceptere Googles servicevilkår til forbedring af din brugeroplevelse, skal du vælge "Accept" (OK) for at acceptere dette vilkår.

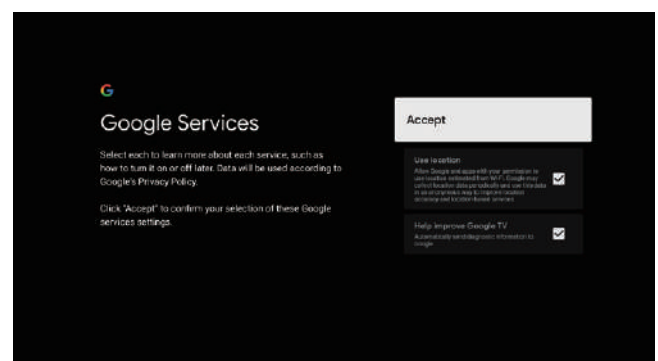

BRUGERVEJLEDNING

Hvis du vil acceptere Googles tjenester til forbedring af din brugeroplevelse, skal du vælge "Accept" (OK) for at acceptere dette vilkår.

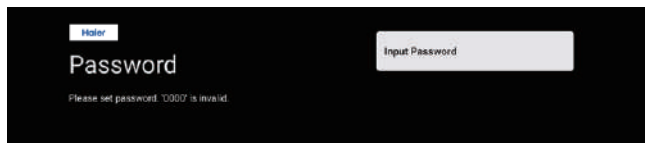

Bruges til indtastning af adgangskoden til din enhed til beskyttelse af din sikkerhed og dit privatliv.

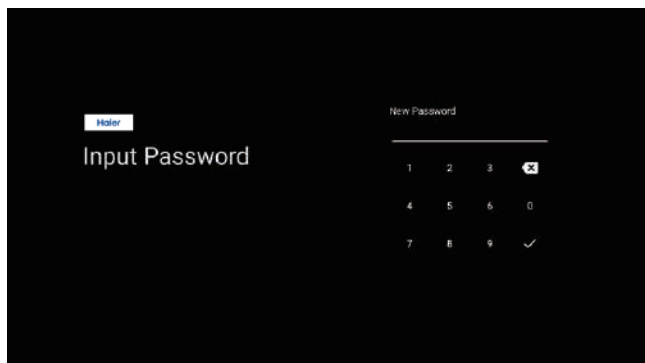

Brug fjernbetjeningen/tastaturet til indtastning af den 4-cifrede adgangskode. Enheden springer automatisk til næste skærm.

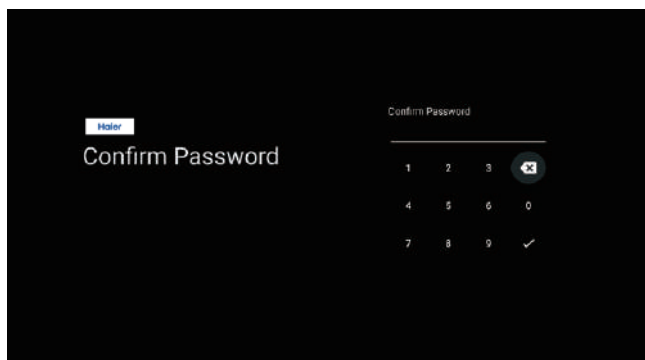

Bekræft adgangskoden ved at indtaste samme kode igen. Brug fjernbetjeningen/tastaturet til indtastning af adgangskoden.

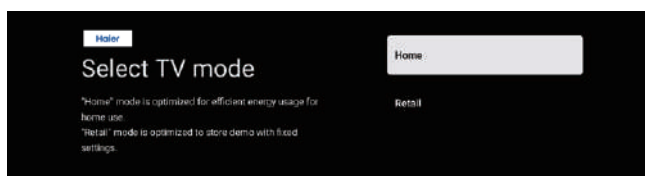

Tryk på knapperne ▲/▼ , vælg Home (Startside), og tryk på OK.

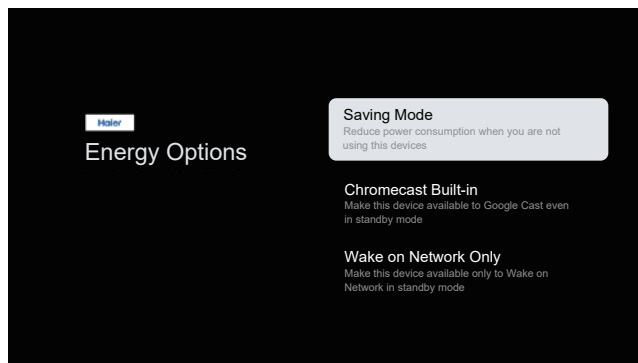

Vælg "Saving Mode" (Strømsparetilstand), og fortsæt til næste trin.

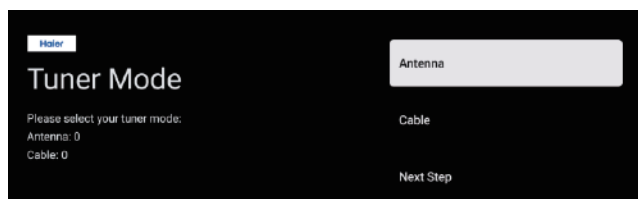

Vælg Tuner mode (Tunertilstand) til søgning, tryk for at vælge, og tryk på OK for at bekræfte.

BRUGERVEJLEDNING

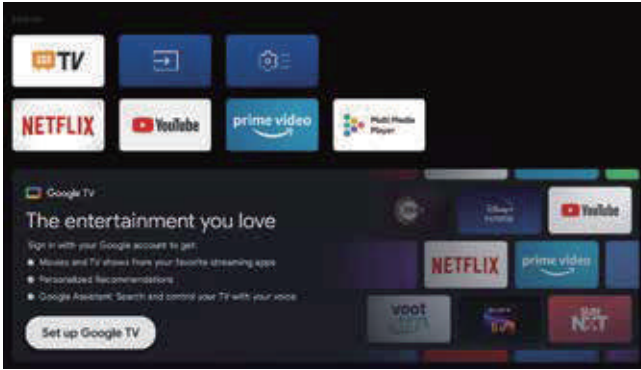

- Når du står i brugergrænsefladen, kan du skifte fra almindeligt TV til Googles TV-indstillinger.



Tryk på knapperne ▲/▼ , vælg "Set up Google TV" (Opsætning af Google TV) på din enhed, og tryk på OK for at færdiggøre opsætningen.

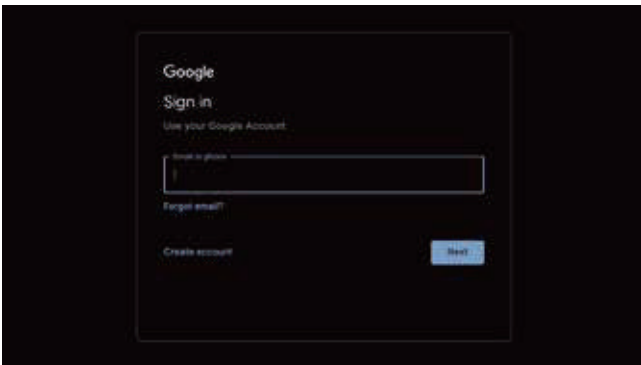

Brug din Google-konto til at logge ind.

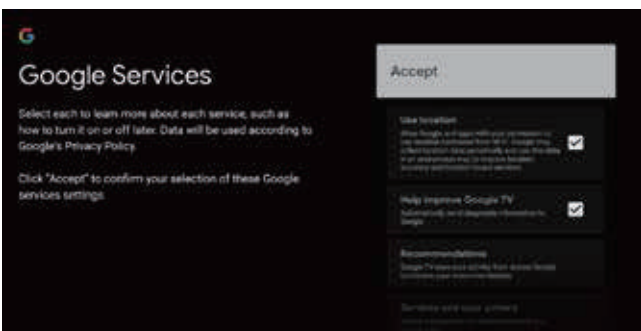
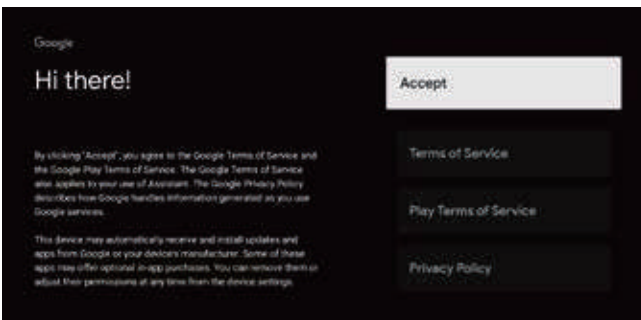

Hvis du vil acceptere Googles servicevilkår til forbedring af din brugeroplevelse, skal du vælge "Accept" (OK) for at acceptere dette vilkår.

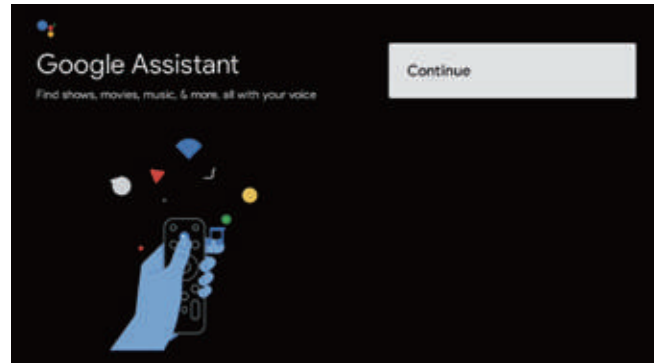

Tryk for at vælge, og tryk på OK for at fortsætte.

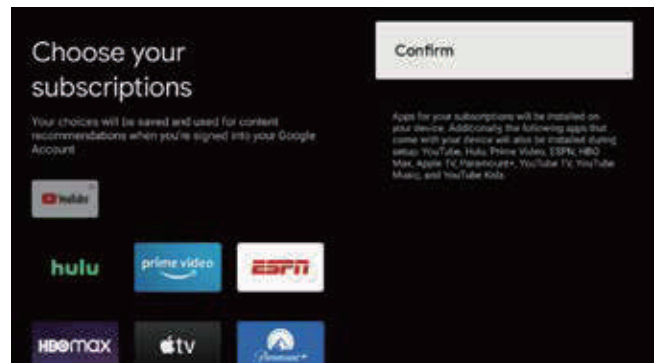

Tryk på knapperne ▲/▼ , vælg dine abonnementer, og tryk på OK.

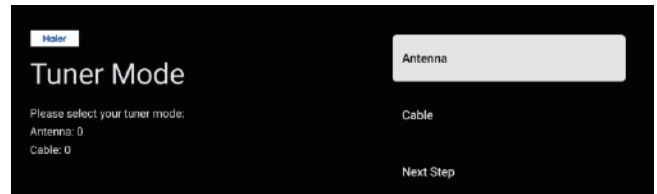

BRUGERVEJLEDNING

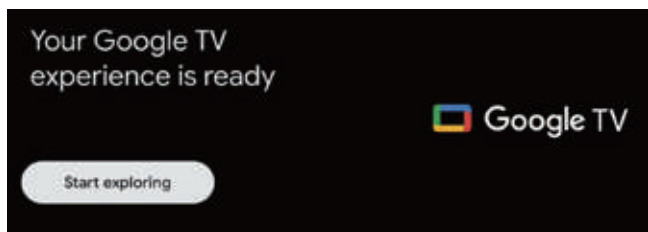

Din Google TV-oplevelse er klar. Tryk på OK for at vælge Start exploring (Start udforskningen).

STARTSKÆRM

Når du har gennemført opsætningsguiden, kan du se TV og gå til startskærmen.

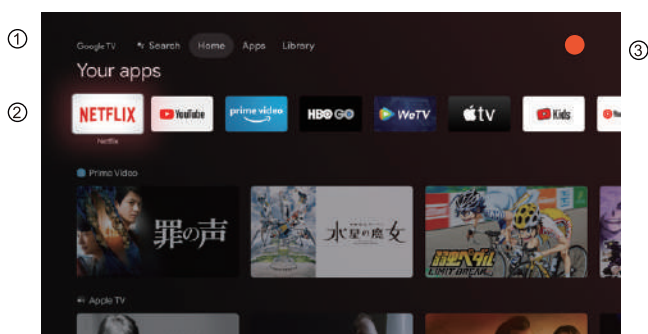

- ① **Search** Åbner Google assistant eller starter en stemmesøgning.
Home Åbner din TV-startside.
Apps Åbner listen med dine installerede apps, hvor du også kan tilføje dine favorittapps.
Library Viser det indhold, du har købt eller lejet via din brugerkonto.
- ② En liste over apps, du har installeret, samt push af indhold fra programmer, du har installeret.
- ③ Åbner dine kontooplysninger, indstillinger, tid, indgange og billeder.
Indstillinger: Her kan du foretage forskellige indstillinger. For nærmere oplysninger om indstillingerne, se næste afsnit.
Indgang: Ikon til valg af signalkilde.
Billede: Her kan du indstille TV-billedet. Se side 12 for en nærmere gennemgang af opsætningen.

NAVIGATION I SKÆRMMENUEN

Du kan åbne på to måder. 1. Under visning af live TV kan du trykke på knappen Menu for at få vist TV-valg. Tryk på knapperne ▲/▼/◀/▶, vælg menuen indstillinger, og tryk på **OK** for at bekræfte. 2. På STARTSKÆRMEN kan du trykke på knappen ▶, vælge ikonet for menuen ⚙️ og trykke på **OK** for at bekræfte.

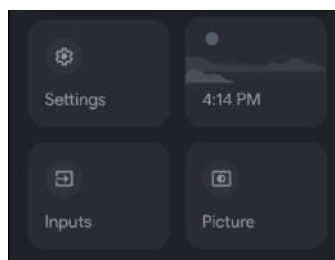
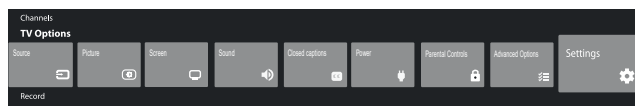

Tryk på knapperne ▲/▼ for at vælge det punkt, du vil indstille. Tryk på **OK** for at åbne indstillingerne.

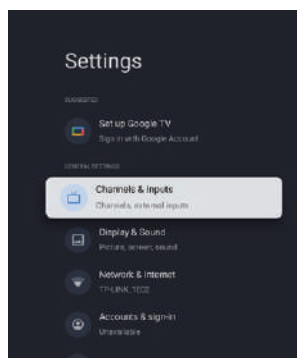

Tryk på TILBAGE for at gå tilbage til foregående menu.

Hvis du står i hovedmenuen, lukkes skærmmenuen, når du trykker på TILBAGE.

BRUGERVEJLEDNING

KANALER

Menu->Settings->Channels & Inputs->Channels (Menu->Indstillinger->Kanaler og indgange->Kanaler).

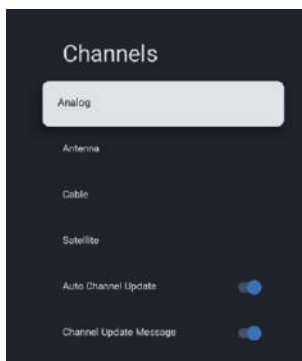

Analog/Antenna/Cable/Satellite (Analog/Antenne/Kabel/Satellit) - Tryk på knappen ▲/▼ for at vælge indstillingen, og tryk derefter på knappen OK for at åbne undermenuen.

Auto Channel Update (Automatisk kanalopdatering) - Tryk på knappen OK for at vælge **ON/OFF (TIL/FRA)**. Når du vælger ON (TIL), søger systemet automatisk efter og opdaterer kanaler efter fem minutter i standby.

Channel Update Message (Besked om opdatering af kanal) - Tryk på knappen OK for at vælge **ON/OFF (TIL/FRA)**. Når du vælger ON (TIL), viser systemet en besked om opdateringen.

Bemærk: De tilgængelige kilder varierer muligvis afhængig af model.

INDGANGE

Menu->Settings->Channels & Inputs->Inputs (Menu->Indstillinger->Kanaler og indgange->Indgange)

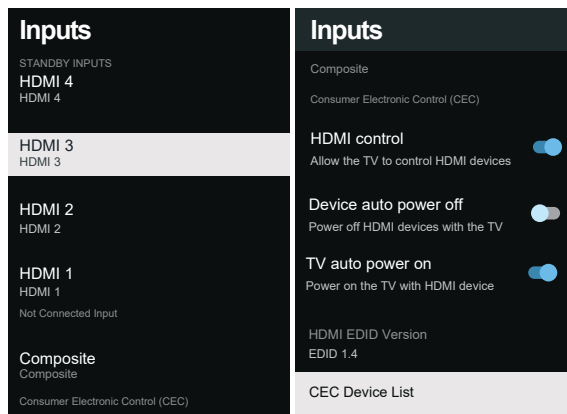

Inputs (Indgange) – Tryk på knapperne ▲/▼ for at vælge punktet, og tryk dernæst på knappen OK for at åbne undermenuen.

HDMI control (HDMI-styring) – Tryk på knapperne ▲/▼ for at vælge punktet, og tryk dernæst på knappen OK for at vælge mellem Til/Fra.

Device auto power off (Automatisk nedlukning af enhed) – Tryk på knapperne ▲/▼ for at vælge punktet, og tryk dernæst på knappen OK for at vælge mellem Til/Fra.

TV auto power on (Automatisk opstart af TV) – Tryk på knapperne ▲/▼ for at vælge punktet, og tryk dernæst på knappen OK for at vælge mellem Til/Fra.

HDMI EDID Version – Viser EDID-versionen.

CEC Device List (CEC-enhedsliste) – Tryk på knapperne ▲/▼ for at vælge punktet, og tryk dernæst på knappen OK for at åbne undermenuen.

SKÆRM OG LYD

Menu->Settings->Display & Sound (Menu->Indstillinger->Skærm og lyd)

I denne menu kan du foretage indstillinger for billede, lyd og lydudgang for TV'et.

1. Tryk på knapperne ▲/▼ for at vælge det punkt, du vil indstille.
2. Tryk på knappen OK for at bekræfte.
3. Når du har foretaget dine indstillinger, skal du trykke på knappen **TILBAGE** for at vende tilbage til foregående menu.

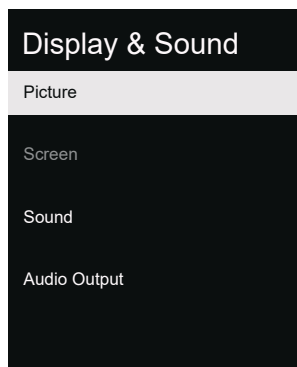

BRUGERVEJLEDNING

BILLEDE

Menu->Settings->Display & Sound-> Picture (Menu->Indstillinger->Skærm og lyd->Billede).

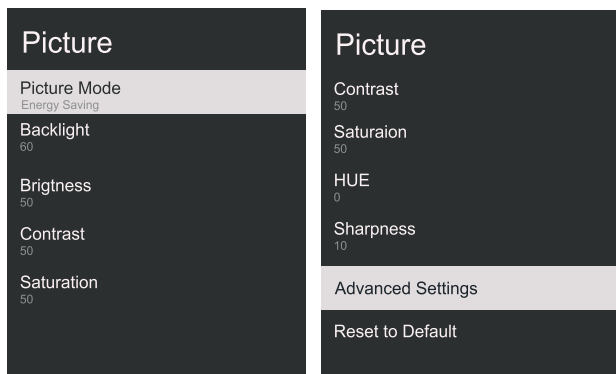

Picture Mode (Billedtilstand) –

Tryk på knapperne ▲/▼ for at vælge punkt, og tryk dernæst på knappen OK for at åbne undermenuen.

(Valgmuligheder: User (Bruger), Standard, Vivid (Kraftig), Sport, Movie (Film), Game (Spil), Energy saving (Energibesparelse)).

Backlight/Brightness/Contrast/Saturation/HUE/Sharpness (Baggrundslys/Lysstyrke/Kontrast/Mætning/Farvetone/Skarphe) – Tryk på knapperne ▲/▼ for at vælge punkt, og tryk dernæst på knappen OK for at åbne.

Tryk på knappen ◀ for at mindske værdien. Tryk på knappen ▶ for at øge værdien. Tryk

Advanced Settings (Avancerede indstillinger) – på knapperne ▲/▼ for at vælge punkt, og tryk dernæst på knappen OK for at åbne undermenuen.

Reset to Default (Gendan standard) – Nulstil alle indstillinger til fabriksindstillingerne.

LYD

Menu->Settings-> Display & Sound->Sound (Menu->Indstillinger->Skærm og lyd->Lyd).

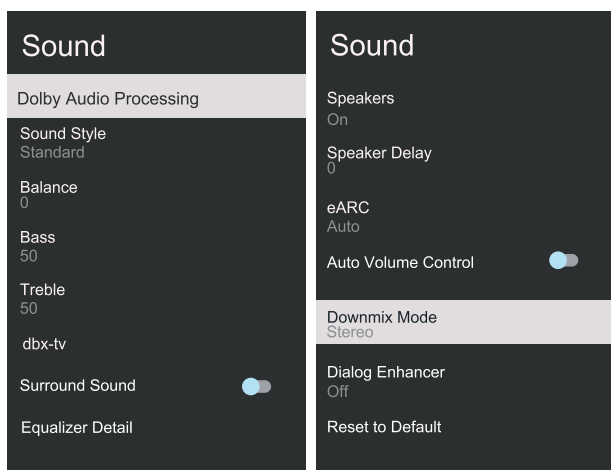

Dolby Audio processing (Dolby lydbehandling) –

Tryk på knapperne ▲/▼ for at vælge punkt, og tryk dernæst på knappen OK for at åbne undermenuen.

Sound style (Lydstil) – Tryk på knapperne ▲/▼ for at vælge punkt, og tryk dernæst på knappen OK for at åbne undermenuen.

(Valgmuligheder: User (Bruger), Standard, Night (Nat), Sports, Movie (Film), Music (Musik), News (Nyheder)).

Balance/ Bass/ Treble (Balance/Bas/Diskant) – Tryk på knapperne ▲/▼ for at vælge punkt, og tryk dernæst på knappen OK for at åbne.

Tryk på knappen ◀ for at mindske værdien.

Tryk på knappen ▶ for at øge værdien.

dbx-tv – Tryk på knapperne ▲/▼ for at vælge punkt, og tryk dernæst på knappen OK for at åbne undermenuen.

Surround Sound (Surroundlyd) – Tryk på knapperne ▲/▼ for at vælge punkt, og tryk dernæst på knappen OK for at vælge mellem Til/Fra.

Equalizer Detail (Equaliserindstillinger) – Tryk på knapperne ▲/▼ for at vælge punkt, og tryk dernæst på knappen OK for at åbne undermenuen.

Speakers (Højttalere) – Tryk på knapperne ▲/▼ for at vælge punkt, og tryk dernæst på knappen OK for at vælge mellem Til/Fra.

Speaker Delay (Højttalerforsinkelse) – Tryk på knapperne ▲/▼ for at vælge punkt, og tryk dernæst på knappen OK for at åbne.

Tryk på knappen ◀ for at mindske værdien. Tryk på knappen ▶ for at øge værdien.

eARC – Tryk på knapperne ▲/▼ for at vælge punkt, og tryk dernæst på knappen OK for at vælge mellem Auto/OFF (Fra).

Auto Volume Control (Automatisk lydstyrkekontrol) – Tryk på knapperne ▲/▼ for at vælge punkt, og tryk dernæst på knappen OK for at vælge mellem Til/Fra.

Downmix Mode (Downmix-tilstand) – Tryk på knapperne ▲/▼ for at vælge punkt, og tryk dernæst på knappen OK for at åbne undermenuen. (Valgmuligheder: Stereo, Surround).

Dialog Enhancer (Dialogforstærkning) – Tryk på knapperne ▲/▼ for at vælge punkt, og tryk dernæst på knappen OK for at åbne undermenuen. (Valgmuligheder: Off, Low, Medium og High (Fra, Lav, Middel og Høj)).

Reset to Default (Gendan standard) – Nulstil alle indstillinger til fabriksindstillingerne.

LYDUDGANG

Menu->Settings->Display & Sound-> Audio Output (Menu->Indstillinger->Skærm og lyd->Lydudgang).

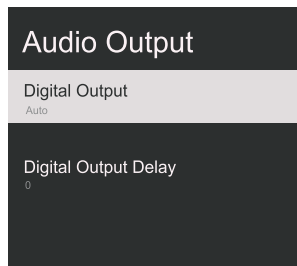

Digital Output (Digital udgang) – Tryk på knapperne ▲/▼ for at vælge punkt, og tryk dernæst på knappen OK for at åbne undermenuen. (Valgmuligheder: Auto, Bypass, PCM, Dolby Digital Plus og Dolby Audio-Dolby Digital).

Digital Output Delay (Forsinkelse på digital udgang) – Tryk på knapperne ▲/▼ for at vælge punkt, og tryk dernæst på knappen OK for at åbne.

Tryk på knappen ◀ for at mindske værdien.

Tryk på knappen ▶ for at øge værdien.

BRUGERVEJLEDNING

NETVÆRK

Menu->Settings->Network & Internet (Menu->Indstillinger->Netværk og internet)

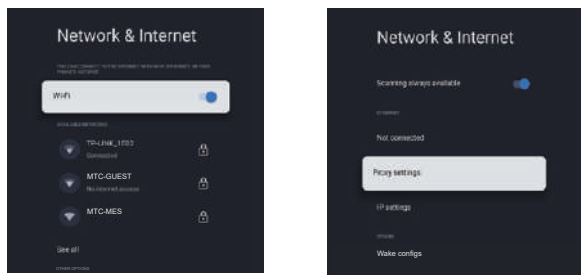

1. Tryk på knapperne ▲/▼ for at vælge det punkt, du vil indstille.
2. Tryk på OK for at bekræfte.
3. Når du har foretaget dine ændringer, skal du trykke på knappen OK for at gemme og vende tilbage til foregående menu.

Konti og login

1. Menu->Settings->Accounts & sign-in (Menu->Indstillinger->Konti og login).
2. Gå ind på STARTSKÆRMEN, tryk på knapperne ▲/▼, vælg "Set up Google TV" (Opsætning af Google TV), og fortsæt til næste trin.

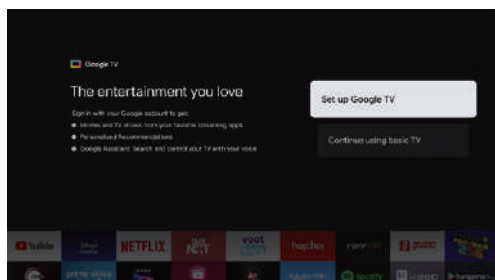

Vælg "Set up Google TV" (Opsætning af Google TV), fortsæt til næste trin, og indtast din konto og adgangskode.

Følg vejledningen på skærmen for at foretage de relevante indstillinger.

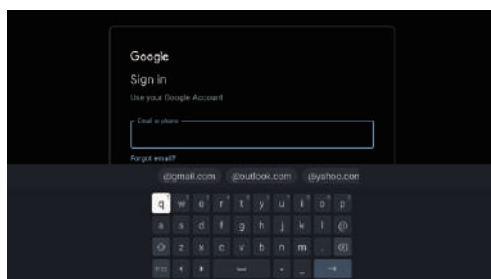

PRIVATLIV

Menu->Settings->Privacy (Menu->Indstillinger->Privatliv).

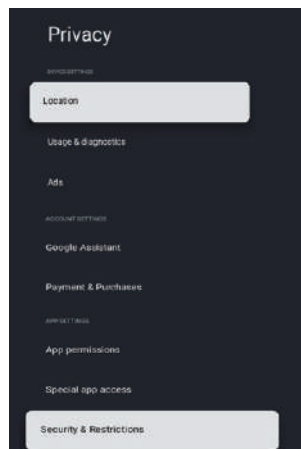

I denne menu kan du angive placering, brug og diagnostik osv. for TV'et.

1. Tryk på knapperne ▲/▼ for at vælge det punkt, du vil indstille.
2. Tryk på **OK** for at bekræfte.
3. Når du har foretaget dine indstillinger, skal du trykke på knappen TILBAGE for at vende tilbage til foregående menu.

PLACERING

Menu->Settings->Privacy ->Location (Menu->Indstillinger->Privatliv->Placering).

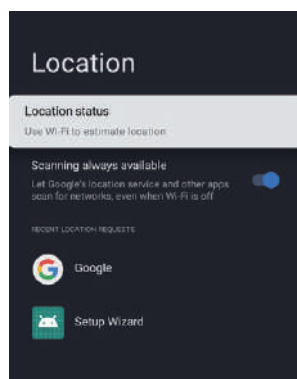

Location status (Status for placering) – Tryk på knapperne ▲/▼ for at vælge punktet, og tryk dernæst på knappen **OK** for at åbne undermenuen. (Valgmuligheder: Use Wi-Fi to estimate location, Off (Brug wi-fi til estimering af placering, Fra))

Scanning always available (Søgning altid tilgængelig) – Tryk på knapperne ▲/▼ for at vælge punktet, og tryk dernæst på knappen **OK** for at vælge mellem Til/Fra.

BRUGERVEJLEDNING

BRUG OG DIAGNOSTIK

Menu->Settings->Privacy ->Usage & diagnostics
(Menu->Indstillinger->Privatliv->Brug og diagnostik).

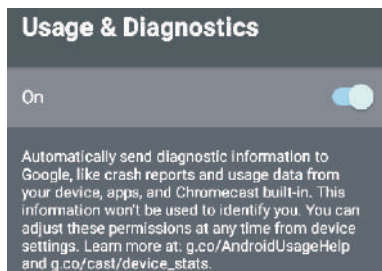

Usage & diagnostics (Brug og diagnostik) – Tryk på knapperne ▲/▼ for at vælge punktet, og tryk dernæst på knappen OK for at vælge mellem Til/Fra.

APPS

Menu->Settings->Apps (Menu->Indstillinger->Apps).

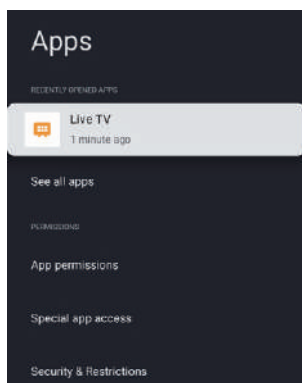

I denne menu kan du angive tilladelser for dine apps og se listen over apps.

1. Tryk på knapperne ▲/▼ for at vælge det punkt, du vil indstille.
2. Tryk på OK for at bekræfte.
3. Når du har foretaget dine indstillinger, skal du trykke på knappen TILBAGE for at vende tilbage til foregående menu.

SYSTEM

Menu->Settings->System (Menu->Indstillinger->System).

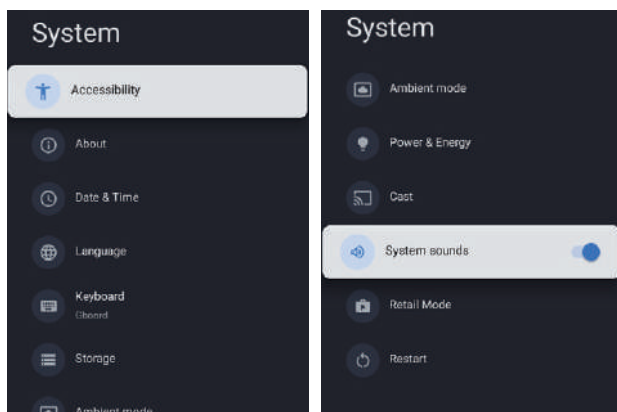

I denne menu kan du se oplysninger og indstillinger for TV'et.

1. Tryk på knapperne ▲/▼ for at vælge det punkt, du vil indstille.
2. Tryk på OK for at bekræfte.
3. Når du har foretaget dine indstillinger, skal du trykke på knappen TILBAGE for at vende tilbage til foregående menu.

System sounds (Systemlyde) - Tryk på knapperne ▲/▼ for at vælge punktet, og tryk dernæst på knappen OK for at vælge mellem Til/Fra.
For oplysninger om systemet, se næste afsnit.

TILGÆNGELIGHED

Menu->Settings->System -> Accessibility (Menu->Indstillinger->System->Tilgængelighed).

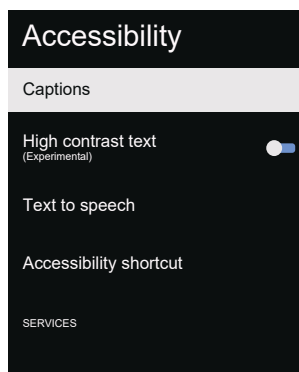

Captions (Billedtekster) – Tryk på knapperne ▲/▼ for at vælge punktet, og tryk dernæst på knappen OK for at åbne undermenuen.

High contrast text (Tekst med høj kontrast) – Tryk på knapperne ▲/▼ for at vælge punktet, og tryk dernæst på knappen OK for at vælge mellem Til/Fra.

Text to speech (Tekst til tale) – Tryk på knapperne ▲/▼ for at vælge punktet, og tryk dernæst på knappen OK for at åbne undermenuen.

Accessibility shortcut (Genvej til tilgængelighed) – Tryk på knapperne ▲/▼ for at vælge punktet, og tryk dernæst på knappen OK for at åbne undermenuen.

OM

Menu->Settings->System ->About (Menu->Indstillinger->System->Om).

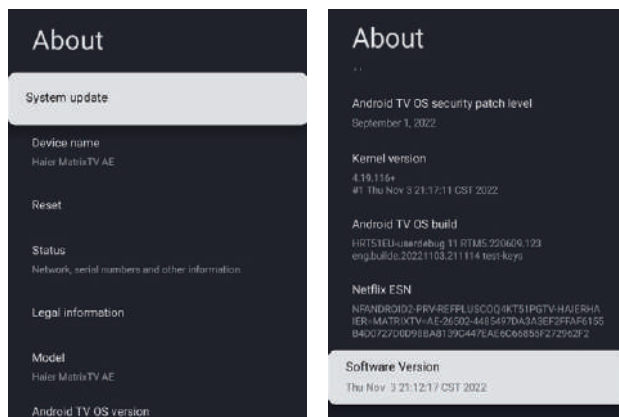

I denne menu kan du opdatere systemet, nulstille og se oplysninger om TV'et.

BRUGERVEJLEDNING

1. Tryk på knapperne ▲/▼ for at vælge det punkt, du vil indstille.
2. Tryk på **OK** for at bekræfte.
3. Når du har foretaget dine indstillinger, skal du trykke på knappen **TILBAGE** for at vende tilbage til foregående menu.

DATO OG TID

Menu->Settings->System -> Date & Time (Menu->Indstillinger->System->Dato og tid).

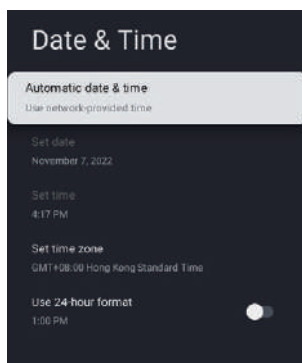

Automatic date & time (Automatisk dato og tid) – Tryk på knapperne ▲/▼ for at vælge punktet, og tryk dernæst på knappen **OK** for at åbne undermenuen. (Valgmuligheder: Use network-provided time, Off (Brug tidsangivelser fra netværket, Fra))

BEMÆRK

- Når indstillingen Automatic date & time (Automatisk dato og klokkeslæt) er indstillet til OFF (FRA), kan du bruge indstillingen Manually adjusting date & time (Manuel justering af dato og klokkeslæt).

Set date (Indstil dato) – Tryk på knapperne ▲/▼ for at vælge punktet, og tryk dernæst på knappen **OK** for at åbne undermenuen.

Set time (Indstil klokkeslæt) – Tryk på knapperne ▲/▼ for at vælge punktet, og tryk dernæst på knappen **OK** for at åbne undermenuen.

Set time zone (Indstil tidszone) – Tryk på knapperne ▲/▼ for at vælge punktet, og tryk dernæst på knappen **OK** for at åbne undermenuen.

Use 24-hour format (Brug 24-timers format) – Tryk på knapperne ▲/▼ for at vælge punktet, og tryk dernæst på knappen **OK** for at vælge mellem Til/Fra.

SPROG

Menu->Settings->System-> Language (Menu->Indstillinger->System->Sprog).

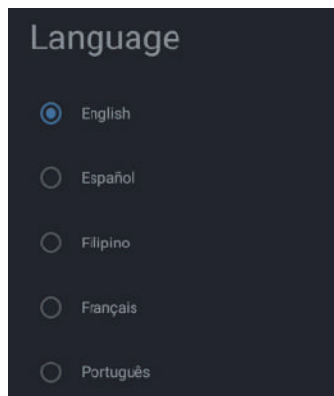

Language (Sprog) – Tryk på knapperne ▲/▼ for at vælge punktet, og tryk dernæst på knappen **OK** for at vælge sprog.

TASTATUR

Menu->Settings->System-> Keyboard (Menu->Indstillinger->System->Tastatur).

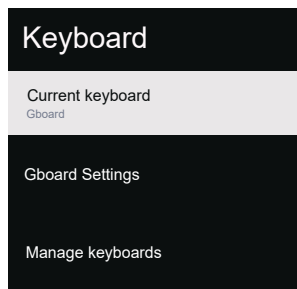

Current keyboard (Aktuelt tastatur) – Tryk på knapperne ▲/▼ for at vælge punktet, og tryk dernæst på knappen **OK** for at åbne undermenuen.

Gboard Settings (Indstillinger for Gboard) – Tryk på knapperne ▲/▼ for at vælge punktet, og tryk dernæst på knappen **OK** for at åbne undermenuen.

Manage keyboards (Administration af tastaturer) – Tryk på knapperne ▲/▼ for at vælge punktet, og tryk dernæst på knappen **OK** for at åbne undermenuen.

LAGER

Menu->Settings-> System->Storage (Menu->Indstillinger->System->Lager).

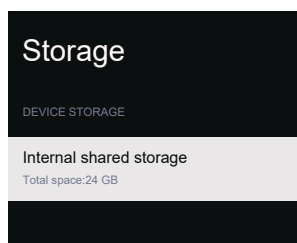

Internal shared storage (Internt delt lager) – Tryk på knapperne ▲/▼ for at vælge punktet, og tryk dernæst på knappen **OK** for at åbne undermenuen.

BRUGERVEJLEDNING

OMGIVENDE TILSTAND

Menu->Settings->System-> Ambient mode (Menu->Indstillinger->System->Omgivende tilstand).

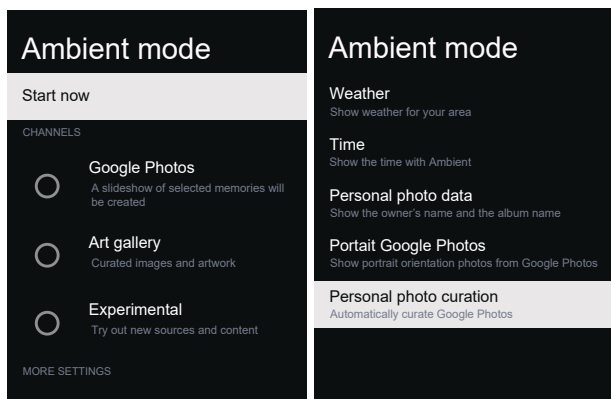

I denne menu kan du foretage indstillinger for omgivende tilstand.

1. Tryk på knapperne ▲/▼ for at vælge det punkt, du vil indstille.
2. Tryk på **OK** for at bekræfte.
3. Når du har foretaget dine indstillinger, skal du trykke på knappen TILBAGE for at vende tilbage til foregående menu.

STRØM OG ENERGI

Menu->Settings-> System->Power & Energy (Menu->Indstillinger->System->Strøm og energi).

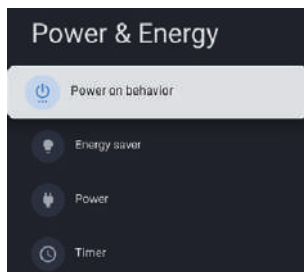

I denne menu kan du foretage indstillinger for strøm og energi.

(power on behavior, energy saver, power and timer (Forhold ved opstart, Energibesparelse, Strøm og timer))

1. Tryk på knapperne ▲/▼ for at vælge det punkt, du vil indstille.
2. Tryk på **OK** for at bekræfte.
3. Når du har foretaget dine indstillinger, skal du trykke på knappen TILBAGE for at vende tilbage til foregående menu.

FORHOLD VED OPSTART

Menu->Settings->System->Power & Energy->Power on behavior (Menu->Indstillinger->System->Strøm og energi->Forhold ved opstart).

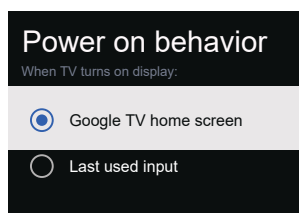

Tryk på knapperne ▲/▼ for at vælge punktet, og tryk dernæst på knappen **OK** for at bekræfte.

ENERGIBESPARELSE

Menu->Settings->System-> Power & Energy ->Energy saver (Menu->Indstillinger->System->Strøm og energi->Energibesparelse).

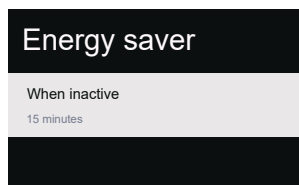

When inactive (Når inaktiv) – Tryk på knapperne ▲/▼ for at vælge punktet, og tryk dernæst på knappen **OK** for at åbne undermenuen.

(Valgmuligheder: 15 minutter, 20 minutter, 30 minutter, 1 time, 4 timer, 8 timer, 12 timer, 24 timer, Never (Aldrig)).

STRØM

Menu->Settings->System-> Power & Energy->Power (Menu->Indstillinger->System->Strøm og energi->Strøm).

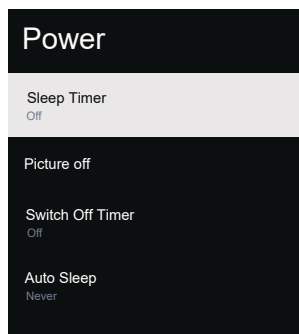

Sleep Timer (Autosluk) – Tryk på knapperne ▲/▼ for at vælge punktet, og tryk dernæst på knappen **OK** for at åbne undermenuen.

(Valgmuligheder: off (Fra), 10 minutter, 20 minutter, 30 minutter, 40 minutter, 50 minutter, 60 minutter, 90 minutter, 120 minutter)

Picture off (Billede fra) – Tryk på knapperne ▲/▼ for at vælge punktet, og tryk dernæst på knappen **OK** for at bekræfte.

Switch off timer (Nedlukningstimer) – Tryk på knapperne ▲/▼ for at vælge punktet, og tryk

BRUGERVEJLEDNING

dernæst på knappen **OK** for at åbne undermenuen. (Valgmuligheder: off (Fra), 30 minutter, 60 minutter, 90 minutter, 120 minutter, 150 minutter, 180 minutter, 210 minutter, 240 minutter)

Auto Sleep (Automatisk dvale) – Tryk på knapperne ▲/▼ for at vælge punktet, og tryk dernæst på knappen **OK** for at åbne undermenuen. (Valgmuligheder: Never (Aldrig), 4 timer, 6 timer 8 timer)

TIMER

Menu->Settings-> System-> Power & Energy->Timer (Menu->Indstillinger->System->Strøm og energi->Timer).

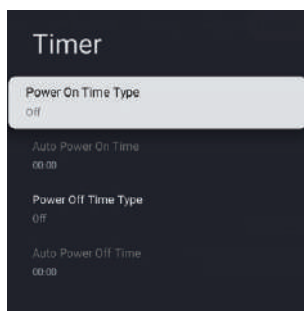

Power On Time Type (Tidstype for opstart) – Tryk på knapperne ▲/▼ for at vælge punktet, og tryk dernæst på knappen **OK** for at vælge mellem ON/OFF/ONCE (Til/Fra/Én gang).

Auto Power On Time (Tidspunkt for automatisk opstart) – Tryk på knapperne ▲/▼ for at vælge punktet, og tryk dernæst på knappen **OK** for at åbne undermenuen.

Power Off Time Type (Tidstype for nedlukning) – Tryk på knapperne ▲/▼ for at vælge punktet, og tryk dernæst på knappen **OK** for at vælge mellem ON/OFF/ONCE (Til/Fra/Én gang).

Auto Power Off Time (Tidspunkt for automatisk nedlukning) – Tryk på knapperne ▲/▼ for at vælge punktet, og tryk dernæst på knappen **OK** for at åbne undermenuen.

UDSENDELSE

Menu->Settings->System-> Cast (Menu->Indstillinger->System->Udsendelse).

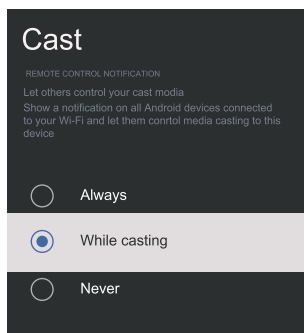

1. Tryk på knapperne ▲/▼ for at vælge det punkt, du vil indstille.
2. Tryk på **OK** for at bekræfte.

3. Tryk på knappen **TILBAGE** for at vende tilbage til foregående menu.

DETAILTILSTAND

Menu->Settings->System-> Retail Mode (Menu->Indstillinger->System->Detailtilstand).

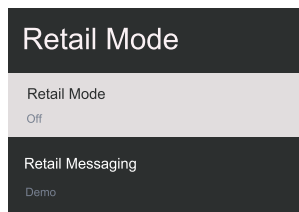

Retail mode (Detailtilstand) – Tryk på knapperne ▲/▼ for at vælge punktet, og tryk dernæst på knappen **OK** for at vælge mellem Til/Fra.

Retail messaging (Detailbeskeder) – Tryk på knapperne ▲/▼ for at vælge punktet, og tryk dernæst på knappen **OK** for at åbne undermenuen. (Bemærk: Demo, e-POP, e-POP + Demo)

GENSTART

Menu->Settings->System-> Restart (Menu->Indstillinger->System->Genstart).

Tryk på knappen **OK** for at åbne undermenuen. (Valgmuligheder: Restart og Cancel (Genstart og Annullér))

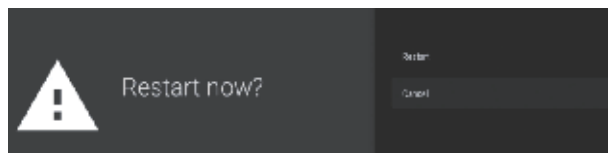

FJERNBETJENINGER OG TILBEHØR

Menu->Settings-> Remotes & Accessories (Menu->Indstillinger->Fjernbetjeninger og tilbehør).

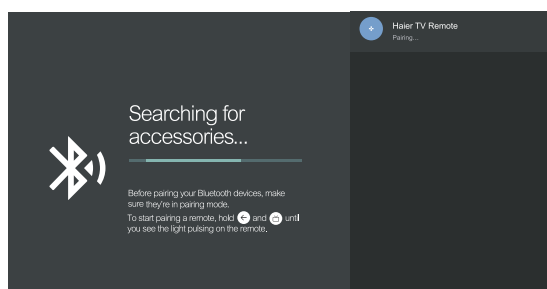
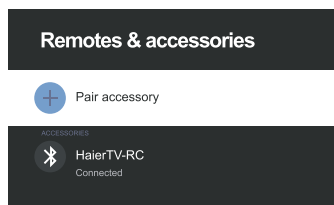

I denne menu kan du parre Bluetooth-enheder.

1. Hold knapperne "←" og "⏻" nederst på fjernbetjeningen inde i 5 sekunder.

BRUGERVEJLEDNING

2. Slip, når LED-kontrollampen begynder at blinke. Fjernbetjeningen sender parringssignalet til TV'et, der viser oplysningerne fra fjernbetjeningen i højre side af skærmen.
3. Tryk på knappen **OK** for at vise parringen. Hvis parringen vises, er forbindelsen blevet oprettet.
4. Hvis skærmen viser, at parringen mislykkedes, er forbindelsen ikke oprettet. Vent 30 sekunder, og hold dernæst knapperne "←" og "⏏" nederst på fjernbetjeningen inde i 5 sekunder for at gentage forrige trin.
5. Tryk på knappen "←" for at vende tilbage til foregående menu.

BRUG AF MULTIMEDIAEFSPILLER

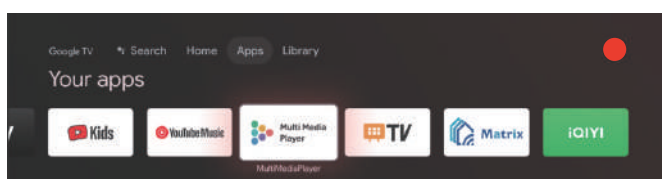

1. Gå ind på STARTSKÆRMEN eller **APPS**, tryk på ▲/▼/◀/▶, og vælg appen Multimediaefspiller.

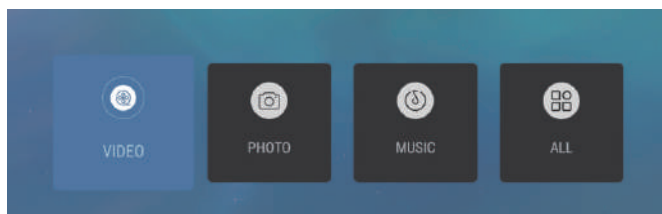

2. Tryk på knappen OK for at åbne Multimediaefspilleren og afspille video, billeder eller lyd. Efter tilslutning af et USB-flashdrev kan du tilgå filerne på USB-flashdrevet (formatet FAT32).

BEMÆRK

Menuen kan afvige afhængigt af, hvor du købte dit TV.

FEJLFINDING

Prøv disse enkle forslag, før du kontakter service. Disse tips kan spare dig for tid og penge, da udgifterne til installation og opsætning af enheden ikke er dækket under garantien.

Symptomer	Punkter at tjekke og handlinger at udføre
"Spøgelse" eller dobbeltbilleder	<ul style="list-style-type: none">• Dette kan skyldes, at fx høje bygninger eller bakker skygger for antennen. Brug af en retningsorienteret antenne kan forbedre billedet.
Ingen strøm	<ul style="list-style-type: none">• Kontrollér, at TV'ets netledning er forbundet til en stikkontakt.• Kobl TV'et fra lysnettet, og vent i 60 sekunder. Sæt stikket i stikkontakten igen, og tænd TV'et.
Intet billede	<ul style="list-style-type: none">• Kontrollér, om antennekablet er korrekt forbundet til antennestikket på bagsiden af TV'et.• Muligt problem med udsendelsen. Prøv en anden kanal.• Justér indstillingerne for kontrast og lysstyrke.• Kontrollér indstillingen for lukkede billedtekster. Visse TEKST-tilstande kan blokere skærmen.
Godt billede, men ingen lyd	<ul style="list-style-type: none">• Tryk på knappen MUTE på fjernbetjeningen for at sikre, at lyden ikke er slået fra.
God lyd, men dårlig farve	<ul style="list-style-type: none">• Justér indstillingerne for kontrast, farve og lysstyrke.
Dårligt billede	<ul style="list-style-type: none">• Dårlig billedkvalitet kan forekomme, hvis et tændt S-VHS-kamera eller en camcorder er forbundet til TV'et samtidig med andet eksternt udstyr. Sluk en af de tilsluttede enheder.
Sne og støj på billedet	<ul style="list-style-type: none">• Kontrollér antenneforbindelsen.
Vandret stiplede linje	<ul style="list-style-type: none">• Dette kan skyldes elektrisk interferens (fx fra en hårtørrer, lysstofrør osv.). Sluk den forstyrrende enhed.
TV'et reagerer ikke på fjernbetjening	<ul style="list-style-type: none">• Kontrollér, om batterierne virker. Udskift om nødvendigt.• Rengør modtageren til fjernbetjeningen på TV'et.
Pixel (prikker), der altid er mørke eller altid lyse	<ul style="list-style-type: none">• Dit TV er præcisionsfremstillet ved brug af teknologi på ekstremt højt niveau. Dog kan det af og til forekomme, at der er pixel, som ikke vises korrekt. Sådanne pixel kan forekomme på denne type produkt og udgør ikke en fejl på produktet.

BEMÆRK

- Dette produkt anvender et panel bestående af underpixel, der kræver avanceret teknologi at fremstille. Dog kan der være nogle få lyse eller mørke pixel på skærmen. Disse pixel har ingen negativ indvirkning på produktets funktionsevne.



Begreberne HDMI, HDMI High-Definition Multimedia Interface, HDMI Trade dress og HDMI-logoerne er varemærker eller registrerede varemærker tilhørende HDMI Licensing Administrator, Inc.



Dolby, Dolby Vision, Dolby Atmos, Dolby Audio og det dobbelte D-symbol er varemærker tilhørende Dolby Laboratories Licensing Corporation. Fremstillet på licens fra Dolby Laboratories. Fortroligt, ikke-offentliggjort arbejde. Copyright ©2012-2024 Dolby Laboratories. Alle rettigheder forbeholdes.

PRODUKTSPECIFIKATIONER

43" UHD LED TV

TV'ets billedkvalitet:	UHD Integreret digital. Skærmstørrelse: 108 cm Opløsning 3840 x 2160 pixel 60 Hz.
TV-system:	PAL-B/G, SECAM-B/G
DTV Tuner dekoder	DVB-T, DVB-C, DVB-T2, DVB-S2 16/32/64/128/256 QAM-modulation MPEG2, MPEG4, H.265
Tilslutninger:	1 optisk port 2 USB-porte 1 LAN 4 HDMI-stik 1 VIDEO-stik 1 L-stik 1 R-stik 2 RF-stik 1 stik til ØRETELEFONER 1 CI-indstik Understøttede systemer: PAL+SECAM Antal kanaler: 1000(DTV), 100(ATV) TV (RF): 75Ω ubalanceret AV video-indgang: 75 Ω, 1V-P, RCA AV lydindgang: 20 KΩ, 500 mV RMS HDMI-videoindgang: 480i, 480p, 720p, 1080i, 1080p, 2160p Wi-fi: Standard: IEEE 802.11a/b/g/n/ac, Frekvens: 2,4 GHz/5 GHz Bluetooth: V5.1
Lydkvalitet:	Stereo lydsystem. 2 x 10 watt RMS udgangseffekt.
Strømforbrug på standby	≤0,5 W
Digitale funktioner:	Digitalt interaktiv. Digital tekst. Digital videoudsendelse (DVB), undertekster tilgængelige. Automatisk opsætning. Automatisk søgning efter nye stationer. Programguide med Nu vises og Næste program. 7-dages elektronisk programguide (EPG). CI-indstik. Kompatibel med lydbeskrivelse.
Ekstrafunktioner:	UHF/VHF-tuner; Autosluktimer; Forældrekontrol; Billede og tekst Batterier til fjernbetjening 2 x AAA. VESA-montering: 300 x 300 mm Pakkestørrelse (BxHxD): 1075 x 652 x 142 mm TV'ets størrelse (BxHxD) med fod: 957,2 x 607,4 x 240,7 mm TV'ets størrelse (BxHxD) uden fod: 957,2 x 566,7 x 86,6 mm Pakkens vægt: 10 kg TV'ets vægt med fod: 7,2 kg TV'ets vægt uden fod: 6,8 kg

* Den her angivne oversigt over TV'ets dele er udelukkende vejledende.
Variationer kan forekomme, efterhånden som produktteknologien opdateres.
Ret til uvarslet ændring i design og specifikationer forbeholdes.

PRODUKTSPECIFIKATIONER

50" UHD LED TV

TV'ets billedkvalitet:	UHD Integreret digital. Skærmstørrelse: 126 cm Opløsning 3840 x 2160 pixel 60 Hz.
TV-system:	PAL-B/G, SECAM-B/G
DTV Tuner dekoder	DVB-T, DVB-C, DVB-T2, DVB-S2 16/32/64/128/256 QAM-modulation MPEG2, MPEG4, H.265
Tilslutninger:	1 optisk port 2 USB-porte 1 LAN 4 HDMI-stik 1 VIDEO-stik 1 L-stik 1 R-stik 2 RF-stik 1 stik til ØRETELEFONER 1 CI-indstik Understøttede systemer: PAL+SECAM Antal kanaler: 1000(DTV), 100(ATV) TV (RF): 75 Ω ubalanceret AV video-indgang: 75 Ω, 1V-P, RCA AV lydindgang: 20 KΩ, 500 mV RMS HDMI-videoindgang: 480i, 480p, 720p, 1080i, 1080p, 2160p Wi-fi: Standard: IEEE 802.11a/b/g/n/ac, Frekvens: 2,4 GHz/5 GHz Bluetooth: V5.1
Lydkvalitet:	Stereo lydsystem. 2 x 13.5 watt RMS udgangseffekt.
Strømforbrug på standby	≤0,5 W
Digitale funktioner:	Digitalt interaktiv. Digital tekst. Digital videoudsendelse (DVB), undertekster tilgængelige. Automatisk opsætning. Automatisk søgning efter nye stationer. Programguide med Nu vises og Næste program. 7-dages elektronisk programguide (EPG). CI-indstik. Kompatibel med lydbeskrivelse.
Ekstrafunktioner:	UHF/VHF-tuner; Autosluktimer; Forældrekontrol; Billede og tekst Batterier til fjernbetjening 2 x AAA. VESA-montering: 300 x 300 mm Pakkestørrelse (BxHxD): 1250 x 760 x 144 mm TV'ets størrelse (BxHxD) med fod: 1111,2 x 710,5 x 277,2 mm TV'ets størrelse (BxHxD) uden fod: 1111,2 x 651,8 x 88 mm Pakkens vægt: 13,5 kg TV'ets vægt med fod: 10 kg TV'ets vægt uden fod: 9,5 kg

* Den her angivne oversigt over TV'ets dele er udelukkende vejledende.
Variationer kan forekomme, efterhånden som produktteknologien opdateres.
Ret til uvarslet ændring i design og specifikationer forbeholdes.

PRODUKTSPECIFIKATIONER

55" UHD LED TV

TV'ets billedkvalitet:	UHD Integreret digital. Skærmstørrelse: 139 cm Opløsning 3840 x 2160 pixel 60 Hz.
TV-system:	PAL-B/G, SECAM-B/G
DTV Tuner dekoder	DVB-T, DVB-C, DVB-T2, DVB-S2 16/32/64/128/256 QAM-modulation MPEG2, MPEG4, H.265
Tilslutninger:	1 optisk port 2 USB-porte 1 LAN 4 HDMI-stik 1 VIDEO-stik 1 L-stik 1 R-stik 2 RF-stik 1 stik til ØRETELEFONER 1 CI-indstik Understøttede systemer: PAL+SECAM Antal kanaler: 1000(DTV), 100(ATV) TV (RF): 75Ω ubalanceret AV video-indgang: 75 Ω, 1V-P, RCA AV lydindgang: 20 KΩ, 500 mV RMS HDMI-videoindgang: 480i, 480p, 720p, 1080i, 1080p, 2160p Wi-fi: Standard: IEEE 802.11a/b/g/n/ac, Frekvens: 2,4 GHz/5 GHz Bluetooth: V5.1
Lydkvalitet:	Stereo lydsystem. 2 x 13,5 watt RMS udgangseffekt.
Strømforbrug på standby	≤0,5 W
Digitale funktioner:	Digitalt interaktiv. Digital tekst. Digital videoudsendelse (DVB), undertekster tilgængelige. Automatisk opsætning. Automatisk søgning efter nye stationer. Programguide med Nu vises og Næste program. 7-dages elektronisk programguide (EPG). CI-indstik. Kompatibel med lydbeskrivelse.
Ekstrafunktioner:	UHF/VHF-tuner; Autosluktimer; Forældrekontrol; Billede og tekst Batterier til fjernbetjening 2 x AAA. VESA-montering: 300 x 300 mm Pakkestørrelse (BxHxD): 1350 x 837 x 144 mm TV'ets størrelse (BxHxD) med fod: 1225,8 x 777,3 x 277,2 mm TV'ets størrelse (BxHxD) uden fod: 1225,8 x 719,4 x 88,1 mm Pakkens vægt: 16,4 kg TV'ets vægt med fod: 11,9 kg TV'ets vægt uden fod: 11,4 kg

* Den her angivne oversigt over TV'ets dele er udelukkende vejledende.
Variationer kan forekomme, efterhånden som produktteknologien opdateres.
Ret til uvarslet ændring i design og specifikationer forbeholdes.

PRODUKTSPECIFIKATIONER

65" UHD LED TV

TV'ets billedkvalitet:	UHD Integreret digital. Skærmstørrelse: 164 cm Opløsning 3840 x 2160 pixel 60 Hz.
TV-system:	PAL-B/G, SECAM-B/G
DTV Tuner dekoder	DVB-T, DVB-C, DVB-T2, DVB-S2 16/32/64/128/256 QAM-modulation MPEG2, MPEG4, H.265
Tilslutninger:	1 optisk port 2 USB-porte 1 LAN 4 HDMI-stik 1 VIDEO-stik 1 L-stik 1 R-stik 2 RF-stik 1 stik til ØRETELEFONER 1 CI-indstik Understøttede systemer: PAL+SECAM Antal kanaler: 1000(DTV), 100(ATV) TV (RF): 75 Ω ubalanceret AV video-indgang: 75 Ω, 1V-P, RCA AV lydindgang: 20 KΩ, 500 mV RMS HDMI-videoindgang: 480i, 480p, 720p, 1080i, 1080p, 2160p Wi-fi: Standard: IEEE 802.11a/b/g/n/ac, Frekvens: 2,4 GHz/5 GHz Bluetooth: V5.1
Lydkvalitet:	Stereo lydsystem. 2 x 13,5 watt RMS udgangseffekt.
Strømforbrug på standby	≤0,5 W
Digitale funktioner:	Digitalt interaktiv. Digital tekst. Digital videoudsendelse (DVB), undertekster tilgængelige. Automatisk opsætning. Automatisk søgning efter nye stationer. Programguide med Nu vises og Næste program. 7-dages elektronisk programguide (EPG). CI-indstik. Kompatibel med lydbeskrivelse.
Ekstrafunktioner:	UHF/VHF-tuner; Autosluktimer; Forældrekontrol; Billede og tekst Batterier til fjernbetjening 2 x AAA. VESA-montering: 400 x 300 mm Pakkestørrelse (BxHxD): 1600 x 960 x 164 mm TV'ets størrelse (BxHxD) med fod: 1446,4 x 904,7 x 313,8 mm TV'ets størrelse (BxHxD) uden fod: 1446,4 x 841,3 x 85,1 mm Pakkens vægt: 24 kg TV'ets vægt med fod: 17,2 kg TV'ets vægt uden fod: 16,5 kg

* Den her angivne oversigt over TV'ets dele er udelukkende vejledende.
Variationer kan forekomme, efterhånden som produktteknologien opdateres.
Ret til uvarslet ændring i design og specifikationer forbeholdes.

Haier

Haier

Inspiriertes Leben

Bedienungsanleitung

MODELLE:

H43Q80FUX

H50Q80FUX

H55Q80FUX

H65Q80FUX



Die in dieser Bedienungsanleitung enthaltenen Abbildungen dienen lediglich der Veranschaulichung und können vom tatsächlichen Erscheinungsbild des Produkts abweichen.

Änderungen am Design und an den Spezifikationen des Produkts ohne vorherige Ankündigung vorbehalten.

LED-
Fernsehgerät

INHALTSVERZEICHNIS

1. WICHTIGE SICHERHEITSHINWEISE	1
2. VORBEREITUNG	4
3. ANSCHLÜSSE FÜR PERIPHERIEGERÄTE UND BEDIENELEMENTE.....	6
4. ANSCHLIESSEN VON GERÄTEN	7
5. BEDIENUNGSANLEITUNG.....	8
6. PROBLEMLÖSUNGEN	22
7. TECHNISCHE DATEN	23



Die in dieser Bedienungsanleitung enthaltenen Abbildungen dienen lediglich der Veranschaulichung und können vom tatsächlichen Erscheinungsbild des Produkts abweichen.
Änderungen am Design und an den Spezifikationen des Produkts ohne vorherige Ankündigung vorbehalten.

WICHTIGE SICHERHEITSHINWEISE

- 1) Lesen Sie sich diese Bedienungsanleitung sorgfältig durch.
- 2) Bewahren Sie diese Bedienungsanleitung sicher auf.
- 3) Beachten Sie sämtliche der darin aufgeführten Warnhinweise.
- 4) Befolgen Sie sämtliche der darin aufgeführten Anweisungen.
- 5) Verwenden Sie dieses Produkt nicht in der Nähe von Wasser.
- 6) Verwenden Sie zur Reinigung des Produkts ausschließlich ein trockenes Tuch.
- 7) Decken Sie unter keinen Umständen die Lüftungsöffnungen ab und beachten Sie sämtliche der auf die Aufstellung des Produkts bezogenen Anweisungen.
- 8) Stellen Sie das Produkt nicht in der Nähe von Wärmequellen wie Heizkörpern, Öfen oder anderen Geräten (einschließlich Verstärkern) auf.
- 9) Umgehen Sie unter keinen Umständen den Sicherheitsmechanismus des polarisierten Netzsteckers. Sollte der sich an dem Produkt befindliche Netzstecker nicht ordnungsgemäß in Ihre Netzsteckdose passen, wenden Sie sich an eine Elektrofachkraft und lassen Sie die veraltete Steckdose ersetzen.
- 10) Sorgen Sie dafür, dass niemand auf das Netzkabel treten kann und es keine Schäden durch Einklemmen davonträgt. Dies gilt insbesondere für Netzstecker, Netzsteckdosen und die Stelle, an der das Kabel aus dem Gerät heraustritt.
- 11) Verwenden Sie ausschließlich vom Hersteller angegebene Anbau-/Zubehörteile.
- 12) Trennen Sie das Produkt während eines Gewitters oder bei längerem Nichtgebrauch stets von der Stromversorgung.
- 13) Überlassen Sie jegliche Reparatur qualifiziertem Kundendienstpersonal. Wartungsarbeiten sind immer dann erforderlich, wenn das Produkt in irgendeiner Weise beschädigt wurde, z. B. wenn das Netzkabel oder der Netzstecker beschädigt ist, Flüssigkeiten oder Gegenstände in das Produkt gelangt sind, das Produkt Regen oder Feuchtigkeit ausgesetzt war, es nicht mehr störungsfrei funktioniert oder fallen gelassen wurde.
- 14) Der Netzstecker dient als Trennvorrichtung und muss daher stets leicht zugänglich bleiben.
- 15) Die Belüftung darf nicht durch das Abdecken der Belüftungsöffnungen mit Gegenständen wie Zeitungen, Tischdecken, Gardinen usw. beeinträchtigt werden.
- 16) Stellen Sie keine offenen Flammen (wie brennende Kerzen) auf das Gerät.
- 17) Beachten Sie bei der Entsorgung der Batterien die für Sie geltenden Umweltbestimmungen.
- 18) Das Produkt ist für den Gebrauch in einem gemäßigten Klima konzipiert.
- 19) Das Gerät ist nicht tropf- oder spritzwasserdicht und es dürfen keine mit Flüssigkeit gefüllten Gegenstände wie Vasen auf das Gerät gestellt werden.
- 20) Warnung: Um möglichen Verletzungen, die mit dem Anlehnen an das Produkt einhergehen können, vorzubeugen, sollten Sie stets darauf achten, dass das Produkt waagrecht und vollständig auf der für den Aufstellungsort gewählten Fläche steht.

Die obere Abbildung kann von dem tatsächlichen Erscheinungsbild des Produkts abweichen.

Ist ein am Netzkabel angebrachter Netzstecker als Trennvorrichtung vorgesehen, muss in den Anweisungen zur Montage und Aufstellung ein Hinweis enthalten sein, der darauf hinweist, dass die Netzsteckdose bei mit Netzsteckern ausgestatteten Geräten stets leicht zugänglich sein bzw. bleiben sollte.



 Das Symbol weist darauf hin, dass an diesem Produkt gefährliche Spannungen anliegen, die einen elektrischen Schlag nach sich ziehen können.

 Das Symbol weist auf wichtige Betriebs- und Wartungsanweisungen in den dem Produkt beiliegenden Unterlagen hin.

WARNUNG:

Setzen Sie das Produkt keinem Regen oder Feuchtigkeit aus, um die Gefahr eines Brands oder elektrischen Schlags zu verringern.

WARNUNG:

Setzen Sie Batterien keiner Hitze (z. B. Sonneneinstrahlung, Feuer o. Ä.) aus.



Dieses Symbol weist darauf hin, dass dieses Produkt eine doppelte Isolierung zwischen der potentiell gefährlichen Netzspannung und den für den/die Benutzer/-in zugänglichen Komponenten

WICHTIGE SICHERHEITSHINWEISE

aufweist. Achten Sie bei der Durchführung etwaiger Wartungsarbeiten darauf, ausschließlich baugleiche Ersatzteile zu verwenden.



Diese Kennzeichnung weist darauf hin, dass dieses Produkt nicht gemeinsam mit dem Hausmüll entsorgt werden darf. Das Produkt ist verantwortungsbewusst zu entsorgen, um mögliche Schäden für die Umwelt oder die menschliche Gesundheit durch unkontrollierte Entsorgung von Abfällen zu vermeiden und die nachhaltige Wiederverwendung materieller Ressourcen zu fördern. Nutzen Sie zur Rückgabe Ihres Altgeräts bitte die entsprechend ausgewiesenen Rückgabe- und Sammelstellen oder wenden Sie sich an den Händler, bei dem Sie das Produkt erworben haben. Sie nehmen dieses Produkt zum Zwecke einer umweltfreundlichen Wiederverwertung entgegen.

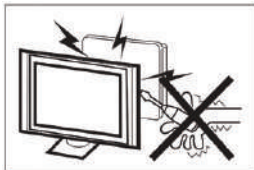

Dieses Fernsehgerät wird mit hohen Spannungen betrieben. Entfernen Sie unter keinen Umständen die Rückblende des Geräts. Lassen Sie sämtliche Wartungsarbeiten von qualifiziertem Wartungspersonal durchführen.

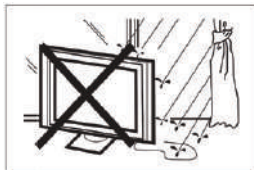

Um die Entstehung eines Brands oder Verletzungen durch einen elektrischen Schlag zu vermeiden, darf das Fernsehgerät weder Regen noch Feuchtigkeit ausgesetzt werden.



Führen Sie keine Gegenstände in die sich am Gehäuse des Fernsehgeräts befindlichen Schlitze oder Öffnungen hinein und lassen Sie auch keine Gegenstände durch sie hineinfallen. Verschütten Sie niemals Flüssigkeiten auf dem Fernsehgerät.



Decken Sie unter keinen Umständen die Lüftungsöffnungen der Rückblende ab. Eine ausreichende Belüftung ist zur Verhinderung eines Ausfalls der elektrischen Komponenten unerlässlich.

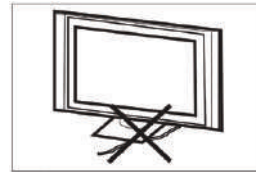

Klemmen Sie das Netzkabel nicht unter dem Fernsehgerät ein.



Trennen Sie vor der Durchführung von Reinigungsarbeiten stets den Netzstecker des Fernsehgeräts von der Netzsteckdose und verwenden Sie weder Wasser noch Chemikalien, sondern ausschließlich ein weiches Tuch.



Stellen Sie sich unter keinen Umständen auf das Fernsehgerät oder seinen Standfuß und sehen Sie davon ab, sich gegen das Gerät zu lehnen oder es ruckartig anzustoßen. Widmen Sie Ihre Aufmerksamkeit insbesondere Kindern, die sich in der Nähe aufhalten. Das Herunterfallen des Geräts kann schwere Verletzungen nach sich ziehen.

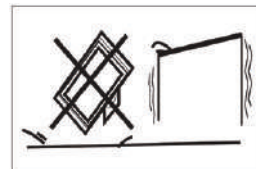

Stellen Sie das Fernsehgerät weder auf einen instabilen Rollwagen, Ständer, oder Tisch noch in ein nicht ordnungsgemäß befestigtes Regal. Das Herunterfallen des Geräts kann schwere Verletzungen und irreparable Schäden am Produkt nach sich ziehen.

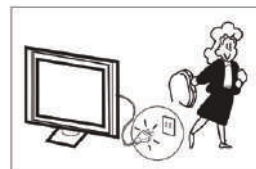

Wir empfehlen, den Netzstecker des Fernsehgeräts bei längerem Nichtgebrauch von der Netzsteckdose zu trennen.



Setzen Sie das Fernsehgerät keiner direkten Sonneneinstrahlung oder anderen Wärmequellen aus. Stellen Sie das Fernsehgerät nicht direkt auf andere

WICHTIGE SICHERHEITSHINWEISE

Geräte, die Wärme abgeben (z. B. Abspielgeräte für Videokassetten und Audioverstärker). Halten Sie das Gerät zudem stets von offenen Flammen (z. B. brennenden Kerzen fern).

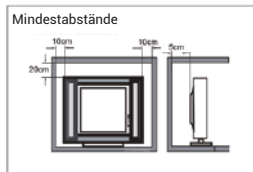

Möchten Sie das Fernsehgerät in einem Fach aufstellen/ montieren oder mit einem ähnlichen Gehäuse versehen, müssen Sie die Einhaltung der angegebenen Mindestabstände sicherstellen. Die Nichtbeachtung dieses Hinweises kann einen Wärmestau nach sich ziehen, der nicht nur die Nutzungsdauer Ihres Geräts verkürzt, sondern auch Gefahren birgt.

Hinweis: Das Produkt ist für den Gebrauch in einem gemäßigten Klima konzipiert.

Achtung: Gefahr durch unzureichende Standsicherheit
Das Fernsehgerät könnte herunterfallen und schwerwiegende oder sogar tödliche Verletzungen verursachen. Mit den folgenden einfachen Vorkehrungen können viele Verletzungen, insbesondere bei Kindern, vermieden werden:

- Verwenden Sie IMMER die vom Hersteller des Fernsehgeräts empfohlenen Schränke, Ständer oder Montagemethoden.
- Verwenden Sie IMMER Möbel, die das Gewicht des Fernsehgeräts sicher tragen können.
- Vergewissern Sie sich IMMER, dass das Fernsehgerät nicht über die Kanten des für die Aufstellung gewählten Möbelstücks hinausragt.
- Informieren Sie Kinder IMMER über die potentiellen Gefahren, die mit dem Klettern auf Möbelstücke zum Zwecke des Erreichens des Fernsehgeräts oder dessen Bedienelemente einhergehen.
- Verlegen Sie die an das Fernsehgerät angeschlossenen Kabel IMMER so, dass man nicht darüber stolpern, daran ziehen oder danach greifen kann.
- Stellen Sie Fernsehgeräte niemals auf einen instabilen Untergrund.
- Stellen Sie das Fernsehgerät nicht auf hohe Möbelstücke (z.B. Küchenschränke oder Bücherregale), es sei denn Sie befestigen sowohl das Möbelstück als auch das Fernsehgerät an einer geeigneten Stützvorrichtung.
- Stellen Sie das Fernsehgerät nicht auf Stoffe oder andere Materialien, die sich zwischen dem Fernsehgerät und dem Möbelstück befinden.
- Stellen Sie NIE Gegenstände, die Kinder zum Klettern verleiten könnten, wie z. B. Spielzeug und Fernbedienungen, auf das Fernsehgerät oder die Möbelstücke, auf denen das Fernsehgerät steht.

Die oben aufgeführten Sicherheitshinweise sind auch dann zu berücksichtigen, wenn Sie das vorhandene Fernsehgerät so wie es ist an einem anderen Ort aufstellen möchten.

VORBEREITUNG

WICHTIG: Üben Sie keinen Druck auf den Anzeigebereich des Displays aus, da dieser anderenfalls irreparabel beschädigt werden könnte. Die Herstellergarantie deckt weder die missbräuchliche Verwendung durch den/die Benutzer/-in noch eine unsachgemäße Montage ab.

MONTIEREN DES STÄNDERS

WICHTIG: Vor der erstmaligen Inbetriebnahme ist der Standfuß an dem Fernsehgerät anzubringen.

1. Legen Sie das Fernsehgerät mit der Vorderseite nach unten auf eine weiche und ebene Unterlage (Decke, Schaumstoff, Tuch usw.), um etwaigen Schäden am Gerät vorzubeugen.
2. Nehmen Sie dann die sechs dem Produkt beiliegenden Schrauben zur Hand und befestigen Sie den Standfuß an der Unterseite des Fernsehgeräts.

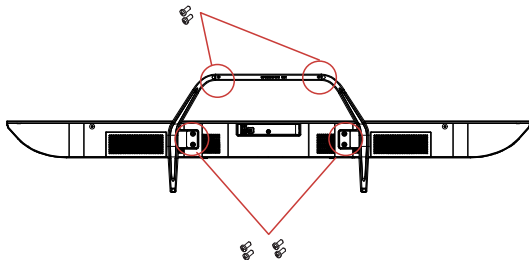

! HINWEIS

Das Erscheinungsbild des Produkts darf nicht verändert werden.

VORBEREITEN DES FERNSEHGERÄTS FÜR DIE WANDMONTAGE

Wir empfehlen, dass Sie Ihr Fernsehgerät in einem Abstand von mindestens 60 mm zur Wand montieren, um Signal- oder Betriebsstörungen durch eingeklemmte Kabel vorzubeugen. Bevor sich Ihr Fernsehgerät an einer Wand anbringen lässt, müssen Sie zunächst einmal den Standfuß entfernen. Verwenden Sie zu Ihrer eigenen Sicherheit ausschließlich mit einem UL-Prüfzeichen versehene Wandhalterungen, deren Tragfähigkeit mindestens dem Gewicht des Fernsehgeräts (ohne Standfuß) entspricht.

Auszuführende Schritte für das Montieren einer Wandhalterung an Ihr Fernsehgerät:

1. Lösen Sie die Schrauben, mit denen der Standfuß an Ihrem Fernsehgerät befestigt ist.
2. Entfernen Sie dann den Standfuß von Ihrem Fernsehgerät.
3. Nehmen Sie nun vier Schrauben zur Hand und befestigen Sie die Wandhalterung an der Rückblende Ihr Fernsehgeräts. Befolgen Sie während der Montage sämtliche der Anweisungen, die in der Wandhalterung beiliegenden Montageanleitung aufgeführt sind.

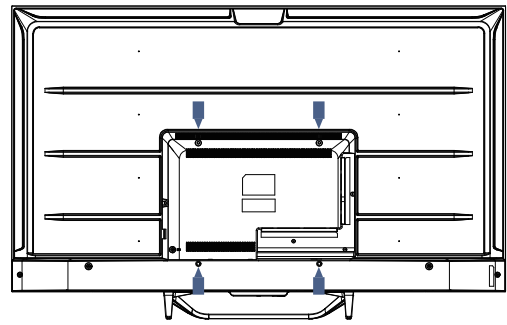

! HINWEIS

Die Wandhalterung ist nicht im Lieferumfang enthalten.

4. Setzen Sie zu guter Letzt die Wandbefestigungsschrauben (M6 x 12 mm/vier Stück) in die Rückblende des LED-Fernsehgeräts ein und ziehen Sie sie mit einem Drehmoment von 1,18 Nm an.

EINSCHALTEN DES FERNSEHGERÄTS

1. Bringen Sie den Standfuß an und stellen Sie das Fernsehgerät auf eine stabile Oberfläche.

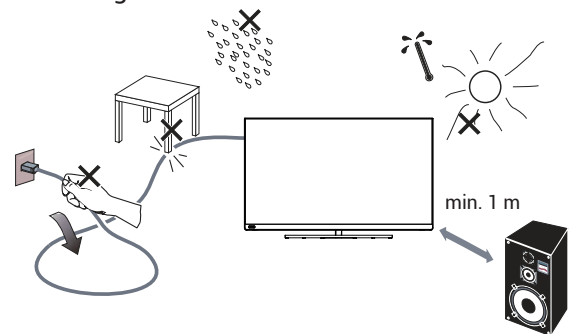

! HINWEIS

- Sorgen Sie beim Aufstellen des Geräts dafür, dass die Luft ungehindert zirkulieren kann. Decken Sie unter keinen Umständen die sich an der Rückblende befindlichen Lüftungsöffnungen ab.
 - Platzieren Sie keine Wärmequellen und offenen Flammen (z. B. eine brennende Kerze) auf oder in der Nähe des Geräts, um etwaigen damit einhergehenden Gefahren vorzubeugen.
 - Halten Sie das Gerät von Hitze, direkter Sonneneinstrahlung, Regen und Wasser fern. Es darf weder tropfenden noch spritzenden Flüssigkeiten ausgesetzt sein.
2. Schließen Sie dann das Antennenkabel oder das Fernkabel an die sich auf der Rückseite des Geräts befindliche **ANT IN**-Antennenbuchse an.
 3. Fernbedienung:
Entfernen Sie die Batteriefachabdeckung. Setzen Sie anschließend zwei Batterien (des Typs AAA, 1,5 V) ein.

ACHTUNG: Werden die Batterien durch Batterien des falschen Typs ersetzt, besteht die Gefahr eines Brandes oder einer Explosion.

VORBEREITUNG

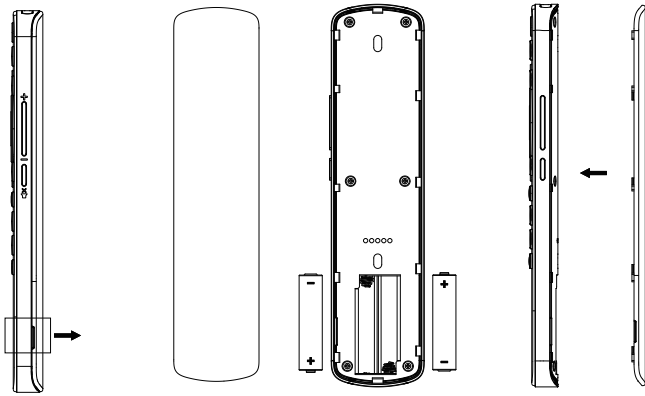

4. Strom:
Schließen Sie nun den Netzstecker an eine geeignete Netzsteckdose an.

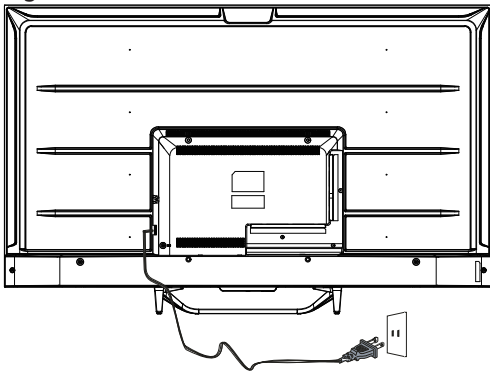

5. Einschalten des Fernsehgeräts:
Drücken Sie zu guter Letzt, die sich auf der Fernbedienung oder an der Seite des Fernsehgeräts befindliche **EIN/AUS**-Taste „“.

ANSCHLÜSSE FÜR PERIPHERIEGERÄTE UND BEDIENELEMENTE

ÜBERSICHT ÜBER DIE BEDIENELEMENTE

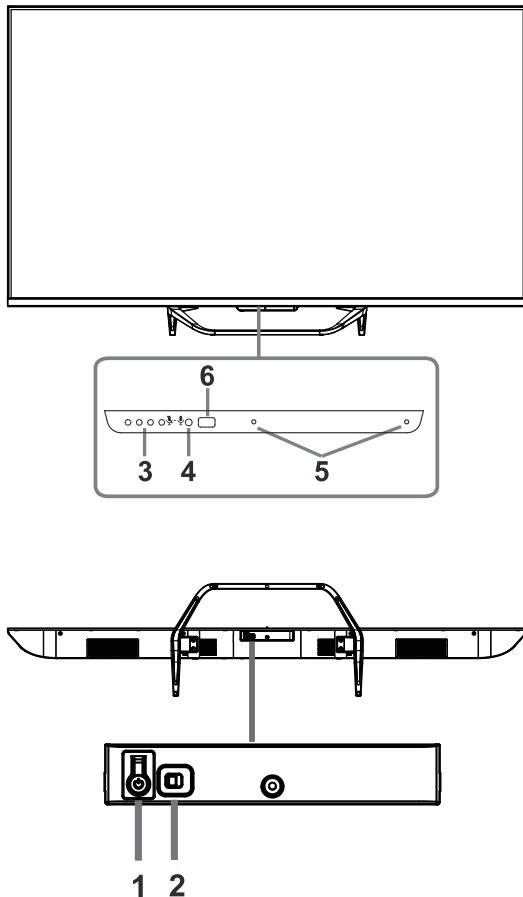

1. Ein-/Aus-schalten
2. Sprachsteuerung aktivieren/deaktivieren
 - 🗣 Mikrofone für Sprachsteuerung aktivieren
 - 🗣 Mikrofone für Sprachsteuerung deaktivieren
 Möchten Sie die Mikrofone für die Sprachsteuerung aktivieren, bringen Sie den Schalter in die rechte Stellung. Die LED-Mikrofonanzeige leuchtet daraufhin kurz auf und erlischt nach erfolgreicher Aktivierung wieder. Sie können nun „Ok Google“ sagen, um die Sprachfunktion zu verwenden. Empfängt das Fernsehgerät Ihre Stimme, leuchtet die LED-Mikrofonanzeige auf, und Sie können dem Gerät Ihren Befehl mitteilen. Möchten Sie die Mikrofone für die Sprachsteuerung deaktivieren, bringen Sie den Schalter zurück in die linke Stellung (LED-Mikrofonanzeige leuchtet daraufhin gelb).
3. LED-Anzeige für Mikrofone der Sprachsteuerung
4. Empfänger des Fernbedienungssignals
5. Empfänger für Sprachsignale
6. Betriebs-LED

! HINWEIS
 Stellen Sie vor dem Verwenden der Sprachsteuerung sicher, dass das Fernsehgerät mit dem Internet verbunden ist.
 Stellen Sie sicher, dass das Fernsehgerät eingeschaltet ist.
 Vergewissern Sie sich, dass Sie mit Ihrem GOOGLE-Konto angemeldet sind.

ZUBEHÖR

- Fernbedienung x 1
- Bedienungsanleitung x 1
- Schraube x 6
- Kurzanleitung x 1
- Garantiekarte x 1

ANSCHLÜSSE FÜR PERIPHERIEGERÄTE



Anschlüsse (von links nach rechts):
 LAN, OPTICAL, VIDEO, L, R, HDMI4, HDMI3, HDMI2



Anschlüsse (von links nach rechts):
 HDMI1 (eARC/ARC), LNB IN (SATELLITE), ANT IN (ANTENNA/CABLE), USB1 , USB2, EARPHONE, COMMON INTERFACE (CI)

ANSCHLIESSEN VON GERÄTEN

ANSCHLIESSEN EINES AV-GERÄTS

Dieses Fernsehgerät bietet Ihnen diverse Anschlüsse für die bequeme Verbindungsherstellung zu AV-Geräten (Wiedergabegeräte für Videokassetten, DVDs usw.).

Weitere Informationen dazu finden Sie in der Bedienungsanleitung des Geräts, das Sie anschließen möchten. An der Rückblende des Fernsehgeräts finden Sie die folgenden Eingänge:

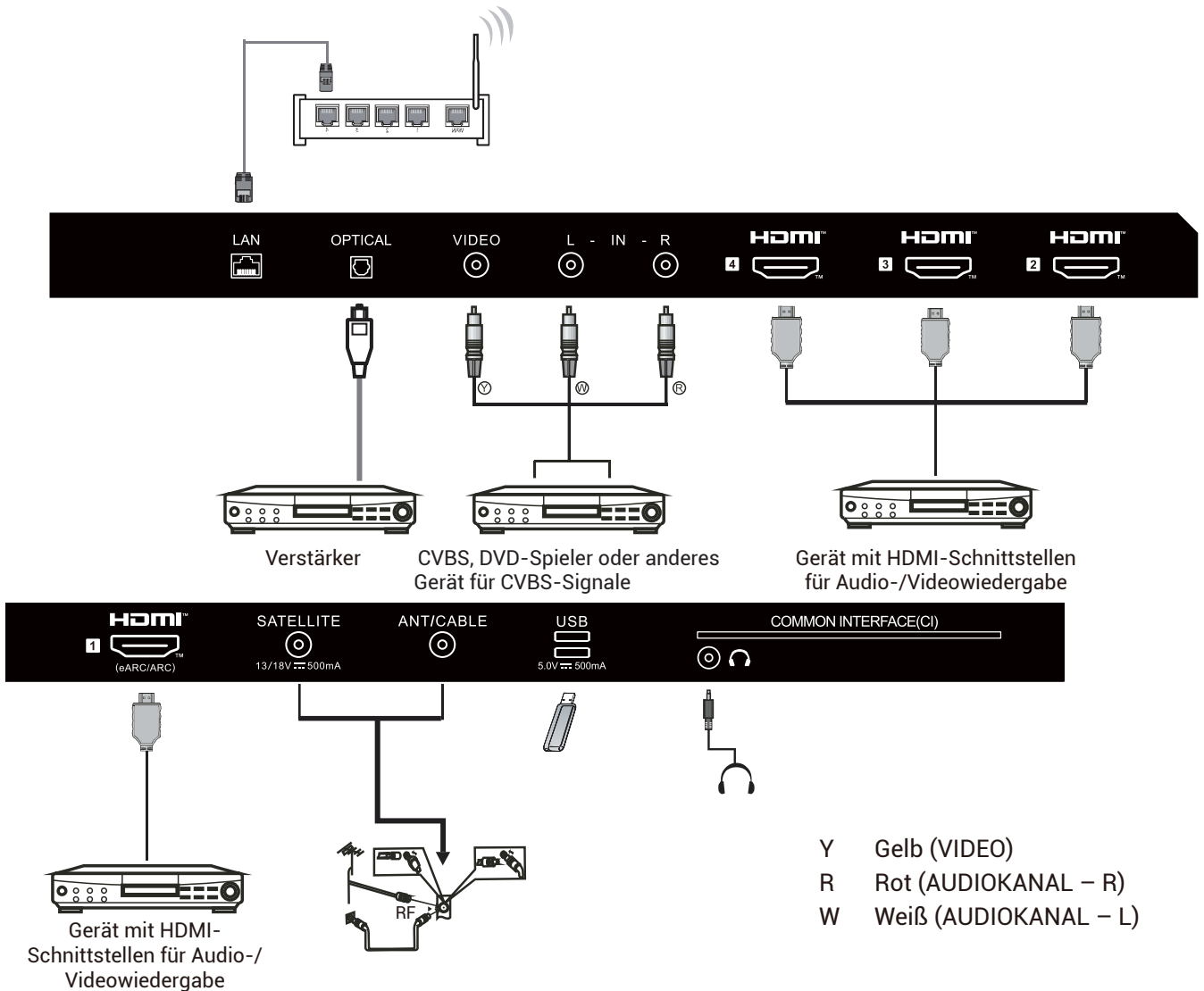

Sie haben die Möglichkeit, die nachstehend aufgeführten Geräte anzuschließen: Videorekorder, Multi-Disc-Spieler, DVD-Spieler, Camcorder, Spielekonsolen, Stereoanlagen usw.

Hinweis:

Beachten Sie, dass dies nicht für alle Geräte gilt, da einige Geräte ein nicht standardisiertes Signal ausgeben.

BEDIENUNGSANLEITUNG

VERWENDEN DER FERNBEDIENUNG



6	←	Rückkehr zum vorherigen Menü.
7	🏠	Drücken Sie diese Taste, um die Startseite aufzurufen.
8	^	Drücken Sie diese Taste, um auf den nächsten Fernsehsender umzuschalten.
9	prime video	Drücken Sie diese Taste, um die App „Amazon Prime Video“ zu starten und sich über das Internet bereitgestellte Sendungen und Filme anzuschauen (Internetverbindung erforderlich).
10	TV	Drücken Sie diese Taste, um sich das aktuelle Fernsehprogramm anzuschauen.
11	▶	Drücken Sie diese Taste, um die App „YouTube Music“ zu starten.
12	NETFLIX	Drücken Sie diese Taste, um die App „NETFLIX“ zu starten.
13	MEDIA	Drücken Sie diese Taste, um den integrierten Multimedia-Player zu starten.
14	🗣️	Drücken Sie diese Taste, um Google Assistant zu starten oder den Beginn der sprachgesteuerten Suche einzuleiten.
15	⚙️	Drücken Sie diese Taste, um das Menü mit den Einstellungen aufzurufen.
16	VOL+/ VOL-	Verwenden Sie die Tasten „VOL+“ und „VOL-“, um den Lautstärkepegel anzupassen.
17	OK	Drücken Sie diese Taste, um in das Untermenü des aktuell ausgewählten Menüpunkts zu gelangen oder den aktuell ausgewählten Vorgang auszuführen.
18	🔇	Drücken Sie diese Taste, um die Stummschaltung zu aktivieren bzw. zu deaktivieren.
19	📺	Drücken Sie diese Taste im Fernsehbetrieb, um den elektronischen Programmführer aufzurufen.
20	∨	Drücken Sie diese Taste, um auf den nächsten Fernsehsender umzuschalten.
21	📺	Drücken Sie diese Taste, um die Liste mit den verfügbaren Eingangsquellen aufzurufen.
22	▶	Drücken Sie diese Taste während der Wiedergabe von Medieninhalten, um die Wiedergabe zu pausieren bzw. fortzusetzen.
23	AUDIO	Drücken Sie diese Taste, um zwischen den Tonspuren umzuschalten.
24	📱	Drücken Sie diese Taste, um die Ansicht mit den Apps aufzurufen.
25	YouTube	Drücken Sie diese Taste, um die App „YouTube“ zu starten.

#	Funktion	Beschreibung
1	🔴 Strom	Drücken Sie diese Taste, um das Fernsehgerät ein- bzw. auszuschalten. Das Fernsehgerät wird im ausgeschalteten Zustand weiterhin mit Strom versorgt. Möchten Sie die Stromversorgung unterbrechen, trennen Sie den Netzstecker von der Netzsteckdose.
2	🌈	Drücken Sie diese Taste, um das Menü für die Farbtasten aufzurufen.
3	☰	Drücken Sie diese Taste, um das Bildschirmmenü aufzurufen bzw. auszublenden.
4	👤	Drücken Sie diese Taste, um Ihre Benutzerkonten aufzurufen und sich bei Google TV anzumelden. (Während der einfachen Einrichtung des Fernsehgeräts hat diese Taste keine Funktion.)
5	⬆️⬇️⬇️⬆️	Verwenden Sie die Navigationstasten, um zwischen den Menüpunkten des Bildschirmmenüs zu navigieren.

BEDIENUNGSANLEITUNG

ERSTEINRICHTUNG

Wenn Sie Ihr Fernsehgerät zum ersten Mal einschalten, werden Sie von dem Assistenten für die Einrichtung durch die Grundeinstellungen geführt. Folgen Sie den eingeblendeten Anweisungen, um das Gerät ordnungsgemäß einzurichten.

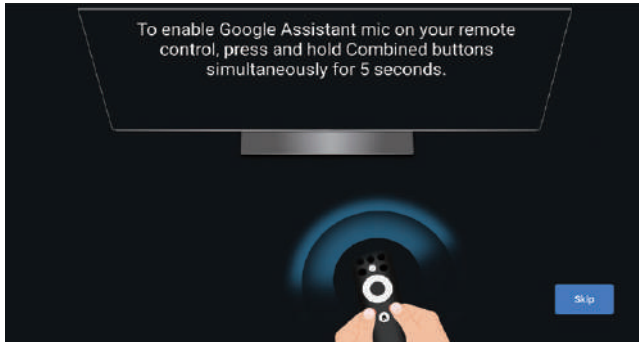

Diese Funktion ist für die Kopplung der Fernbedienung mithilfe einer Tastenkombination vorgesehen. Nach erfolgreicher Kopplung können Sie die Bluetooth-Fernbedienung für die Steuerung Ihres Fernsehgeräts verwenden.

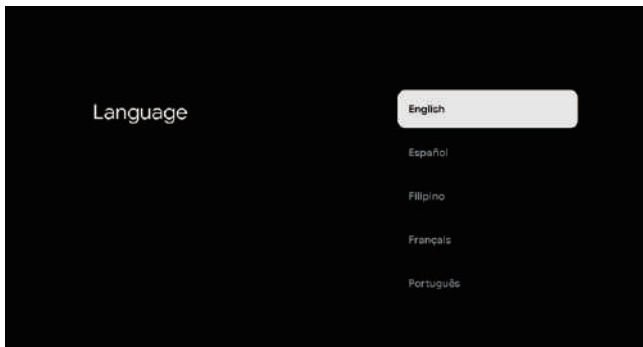

Verwenden Sie die ▲/▼-Tasten, um die gewünschte Systemsprache auszuwählen, und drücken Sie zur Bestätigung Ihrer Auswahl auf die **OK**-Taste.

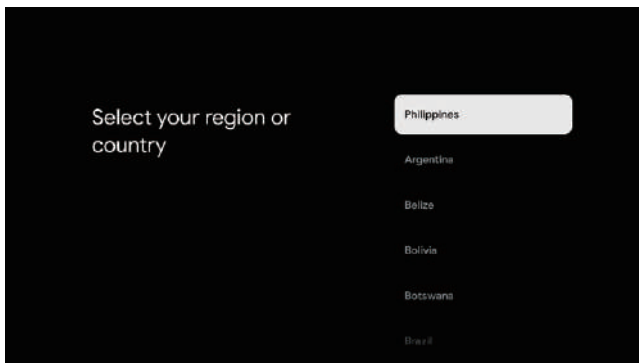

Verwenden Sie die ▲/▼-Tasten, um das Land oder die Region, in dem bzw. der Sie das Gerät nutzen, auszuwählen, und drücken Sie zur Bestätigung Ihrer Auswahl auf die **OK**-Taste.

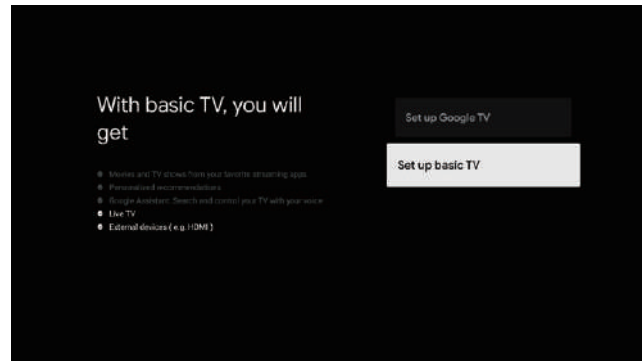

Verwenden Sie die ▲/▼-Tasten, um die Option „Set up basic TV (Grundlegende Einrichtung des Fernsehgeräts)“ auszuwählen, und drücken Sie zum Einleiten des Beginns der Einrichtung auf die **OK**-Taste.

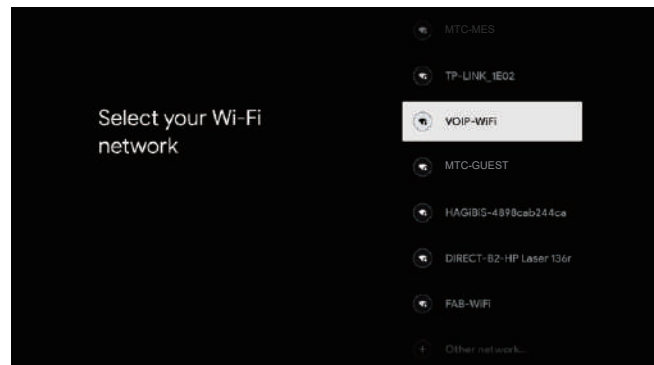

Verwenden Sie die ▲/▼-Tasten, um das WLAN auszuwählen, zu dem Sie eine Verbindung herstellen möchten, drücken Sie zur Bestätigung Ihrer Auswahl auf die **OK**-Taste und geben Sie anschließend den WLAN-Schlüssel ein.

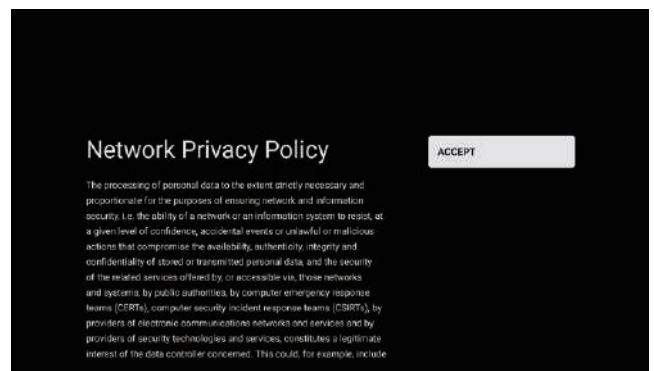

Wählen Sie die Option „Accept (Zustimmen)“, um den Datenschutzbestimmungen für die Netzwerknutzung zuzustimmen.

BEDIENUNGSANLEITUNG

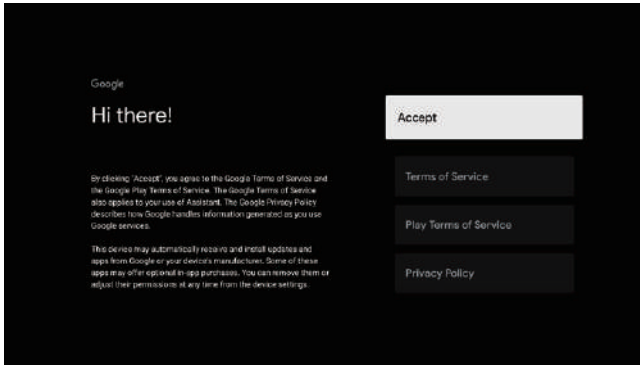

Möchten Sie den Google-Nutzungsbedingungen zur Verbesserung des Benutzererlebnisses zustimmen, wählen Sie erneut die Option „Accept (Zustimmen)“.

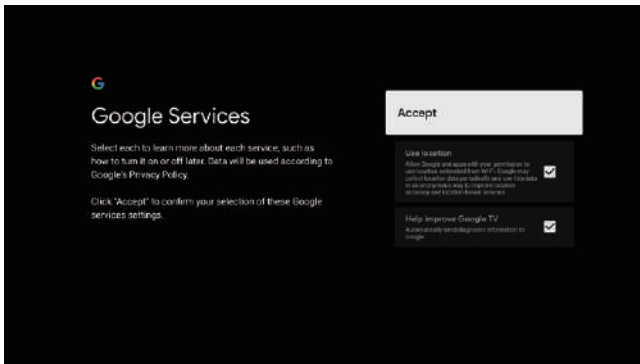

Möchten Sie den Google Play Store-Nutzungsbedingungen zur Verbesserung des Benutzererlebnisses zustimmen, wählen Sie die Option „Accept (Zustimmen)“ ein weiteres Mal.

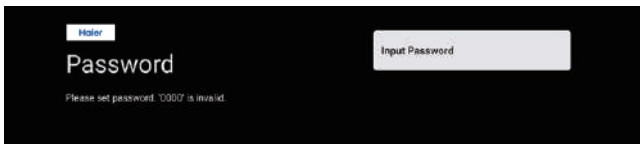

Legen Sie nun das Passwort für Ihr Gerät fest, um die Sicherheit und den Datenschutz zu gewährleisten.

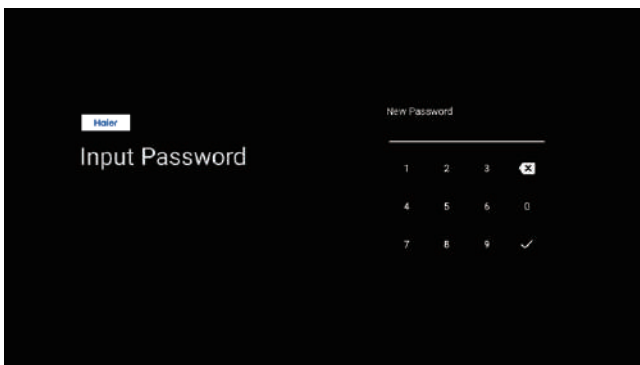

Haben Sie über die Fernbedienung/ Bildschirmtastatur das vierstellige Passwort eingegeben, gelangen Sie automatisch zur nächsten Ansicht.

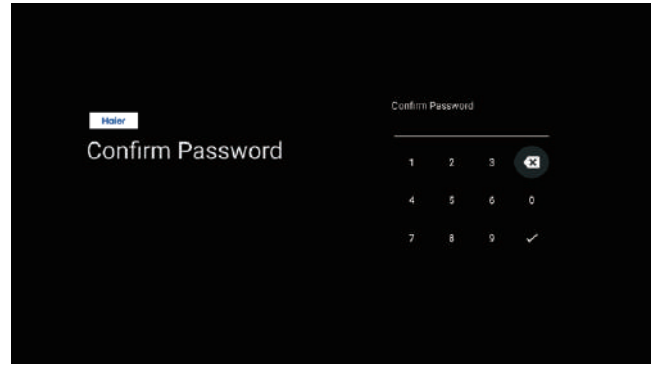

Verwenden Sie die Fernbedienung/ Bildschirmtastatur, um das Passwort erneut einzugeben und den Vorgang abzuschließen.

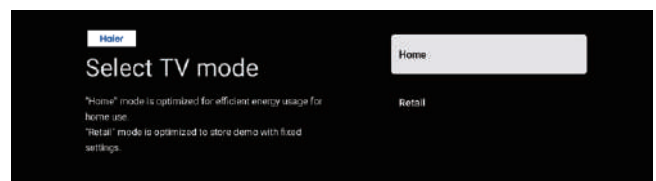

Verwenden Sie die ▲/▼-Tasten, um die Betriebsart für den Heimgebrauch (Home) zu aktivieren, und drücken Sie zur Bestätigung Ihrer Auswahl auf die OK-Taste.

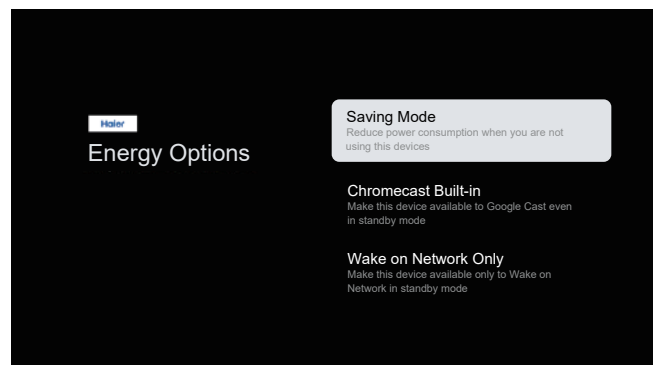

Wählen Sie die Option „Saving Mode (Energiesparmodus)“.

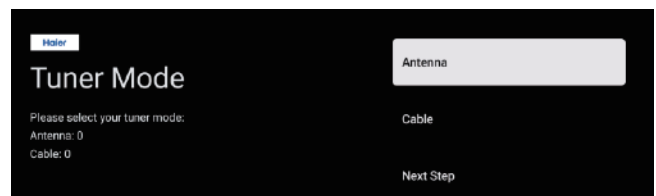

Wählen Sie anschließend den gewünschten Modus für den Sendersuchlauf aus und bestätigen Sie Ihre Auswahl mit einem Druck auf die OK-Taste.

BEDIENUNGSANLEITUNG

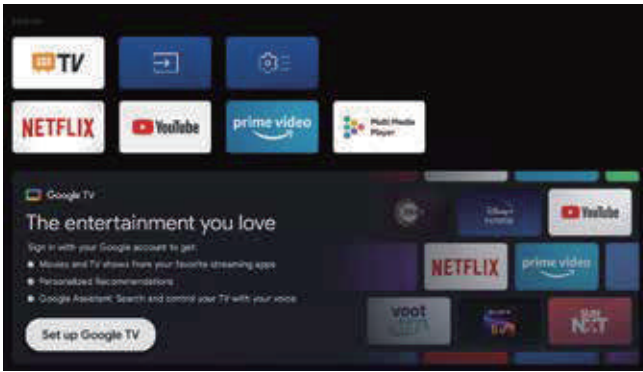

- Auf der Benutzeroberfläche können Sie von der grundlegenden Einrichtung des Fernsehgeräts zu den Google TV-Einstellungen wechseln.

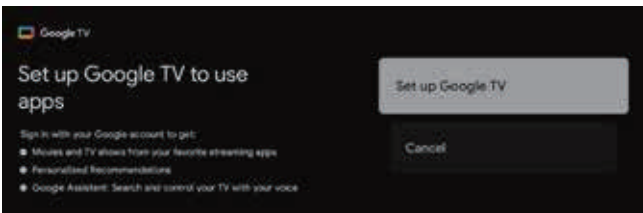

Verwenden Sie die ▲/▼-Tasten, um die Option „Set up Google TV (Einrichtung von Google TV)“ auszuwählen, und drücken Sie zum Einleiten des Beginns der Einrichtung auf die OK-Taste.

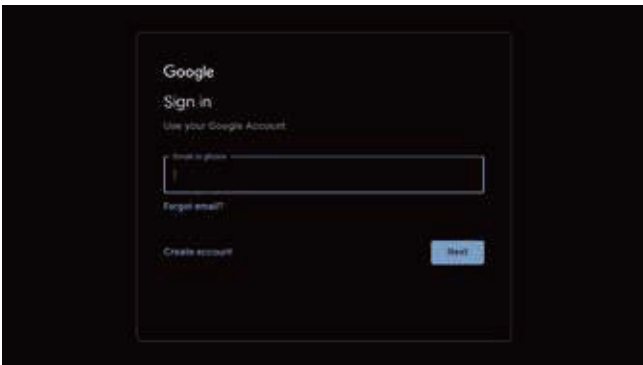

Melden Sie sich mit Ihrem Google-Konto an.

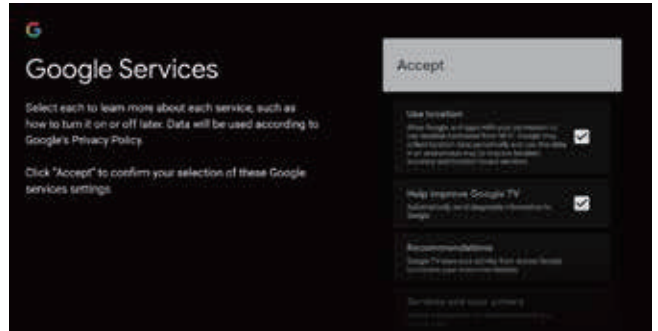
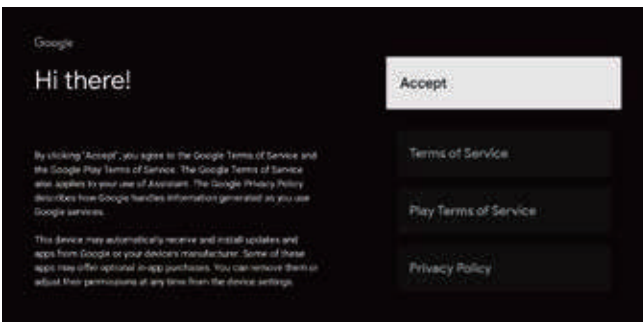

Möchten Sie den Google-Nutzungsbedingungen zur Verbesserung des Benutzererlebnisses zustimmen, wählen Sie erneut die Option „Accept (Zustimmen)“.

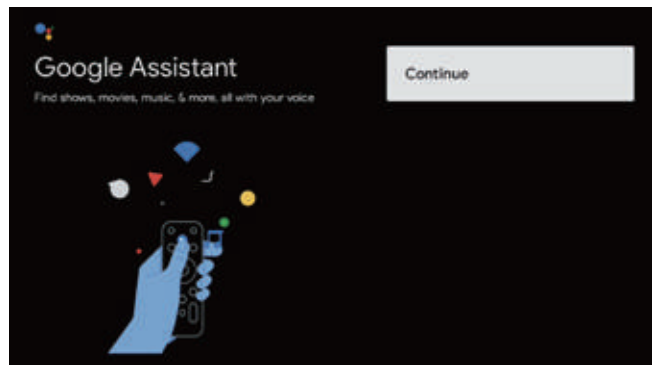

Drücken Sie dann die OK-Taste, um fortzufahren.

BEDIENUNGSANLEITUNG

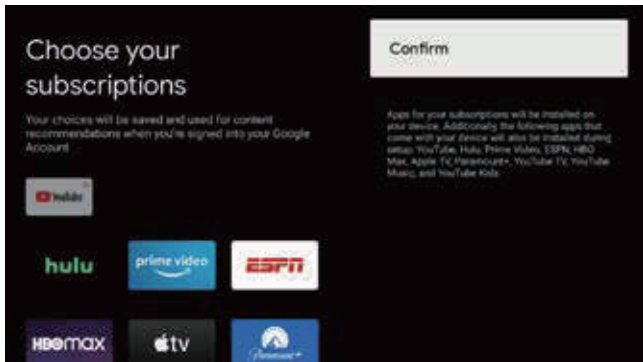

Verwenden Sie die ▲/▼-Tasten, um Ihre Abonnements auszuwählen, und drücken Sie zur Bestätigung Ihrer Auswahl auf die OK-Taste.

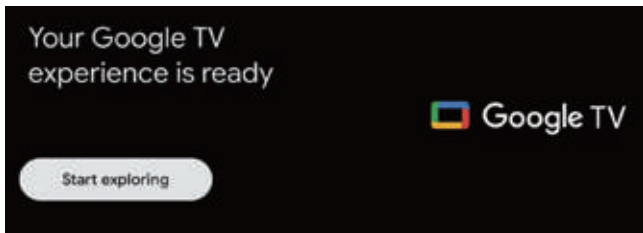

Die Einrichtung von Google TV ist nun abgeschlossen und Sie können nach einem weiteren Druck auf die OK-Taste mit der Suche nach Inhalten beginnen.

STARTBILDSCHIRM

Nachdem Sie die Einrichtung des Assistenten abgeschlossen haben, können Sie fernsehen oder die Startansicht aufrufen.

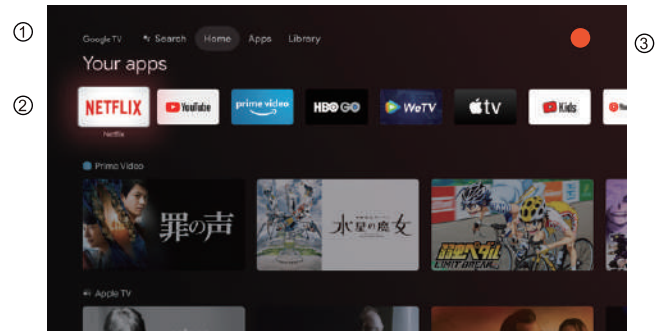

- ① **Search** Wählen Sie diesen Reiter, um den Google Assistent zu starten oder den Beginn der sprachgesteuerten Suche einzuleiten.
Home Wählen Sie diesen Reiter, um die Startseite Ihres Fernsehgeräts aufzurufen.
Apps Wählen Sie diesen Reiter, um eine Liste mit sämtlichen der auf diesem Gerät installierten Apps aufzurufen und Ihre bevorzugten Apps hinzufügen.
Library Wählen Sie diesen Reiter, um die mit diesem Benutzerkonto erworbenen und gemieteten Inhalte anzuzeigen.
- ② Hier werden Ihnen Ihre installierten und der Liste hinzugefügten Anwendungen angezeigt.
- ③ In diesem Bereich können Sie Ihre Kontoinformationen abrufen, die Einstellungen, die Uhrzeit und die Eingabemethoden anpassen sowie Ihr Profilbild ändern.
Einstellungen: Wählen Sie diese Schaltfläche, um eine Ansicht mit zahlreichen konfigurierbaren Einstellungen aufzurufen. Informationen zu den einzelnen Einstellungen finden Sie weiter unten in dieser Bedienungsanleitung.
Eingänge: Wählen Sie diese Schaltfläche, um die gewünschte Eingangsquelle auszuwählen.
Bild: Wählen Sie diese Schaltfläche, um eine Ansicht mit den konfigurierbaren Bildeinstellungen des Fernsehgeräts aufzurufen. Informationen zu den einzelnen Einstellungen finden Sie auf Seite 12.

BEDIENUNGSANLEITUNG

NAVIGATION DURCH DAS BILDSCHIRMMENÜ

Das Aufrufen des Bildschirmmenüs ist auf zwei verschiedenen Wegen möglich. Möchten Sie die erste Methode anwenden, drücken Sie im Fernsehbetrieb die Menü-Taste zur Anzeige der Einstellungen des Fernsehgeräts, verwenden Sie die ▲/▼/◀/▶-Tasten, um das Menü mit den Einstellungen auszuwählen, und bestätigen Sie dann Ihre Auswahl durch Drücken der OK-Taste. Möchten Sie die zweite Methode anwenden, drücken Sie bei aufgerufener Startseite wiederholt die ▶-Taste, um zur Schaltfläche „“ für das Menü mit den Einstellungen zu gelangen, und bestätigen Sie Ihre Auswahl durch Drücken der OK-Taste.

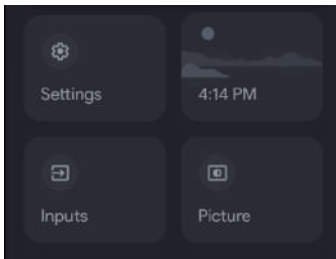
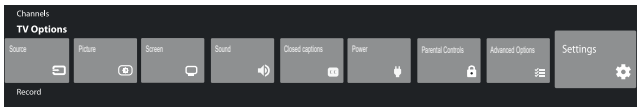

Verwenden Sie die ▲/▼-Tasten, um die Einstellung auszuwählen, die Sie anpassen möchten. Drücken Sie die OK-Taste, um Ihre Auswahl zu bestätigen.

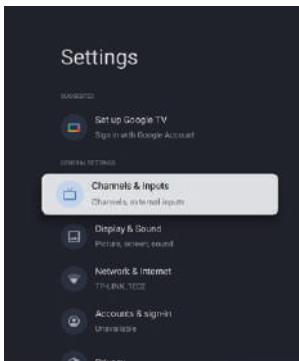

Möchten Sie in das vorherige Menü zurückkehren, drücken Sie die ZURÜCK-Taste. Drücken Sie die ZURÜCK-Taste während Ihnen das Hauptmenü eingeblendet wird, verlassen Sie das Bildschirmmenü.

KANAL

Menü -> Einstellungen -> Channels & Inputs (Sender & Eingangsquellen) -> Channels (Kanal).

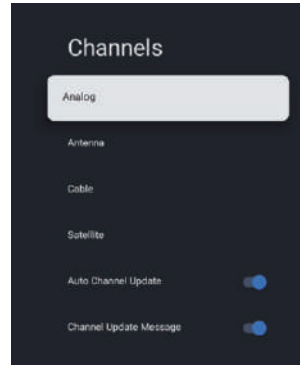

Analog/Antenne/Kabel/Satellit (Analog/Antenna/Cable/Satellite) – Drücken Sie für die Auswahl der Option die Taste ▲/▼ und anschließend die OK-Taste, um in das entsprechende Untermenü zu wechseln.

Autom. Kanalaktualisierung (Auto Channel Update) – Drücken Sie für die Auswahl von EIN/AUS (ON/OFF) die OK-Taste. Wenn Sie „EIN“ (ON) auswählen, scannt und aktualisiert das System nach 5 Minuten im Standby-Modus die Kanäle automatisch.

Kanalaktualisierungsmittlung (Channel Update Message) – Drücken Sie für die Auswahl von EIN/AUS (ON/OFF) die OK-Taste. Wenn Sie „EIN“ (ON) auswählen, zeigt das System eine Aktualisierungsmittlung an.

Hinweis: Die verfügbaren Signalquellen können u. U. je nach Modell variieren.

BEDIENUNGSANLEITUNG

EINGANGSQUELLEN

Menü -> Einstellungen -> Channels & Inputs (Sender & Eingangsquellen) -> Inputs (Eingangsquellen).

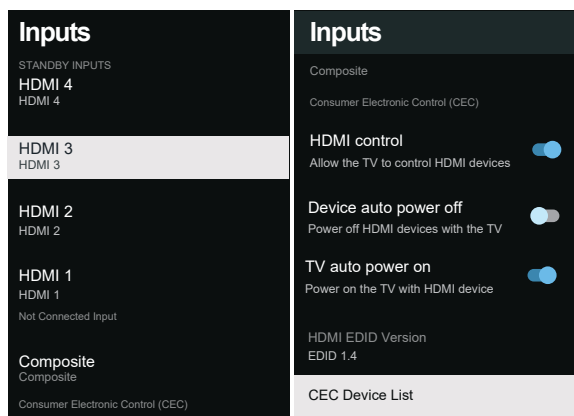

Inputs (Eingangsquellen) – Verwenden Sie die ▲/▼-Tasten, um die Option auszuwählen, und drücken Sie die OK-Taste, um das Untermenü aufzurufen.

HDMI control (HDMI-Steuerung) – Verwenden Sie die ▲/▼-Tasten, um die Option auszuwählen, und drücken Sie die OK-Taste, um sie zu aktivieren bzw. zu deaktivieren.

Device auto power off (Abschaltautomatik) – Verwenden Sie die ▲/▼-Tasten, um die Option auszuwählen, und drücken Sie die OK-Taste, um sie zu aktivieren bzw. zu deaktivieren.

TV auto power on (Einschaltautomatik) – Verwenden Sie die ▲/▼-Tasten, um die Option auszuwählen, und drücken Sie die OK-Taste, um sie zu aktivieren bzw. zu deaktivieren.

HDMI EDID Version (HDMI EDID-Version) – Hier wird Ihnen die aktuelle EDID-Version angezeigt.

CEC Device List (Liste der CEC-Geräte) – Verwenden Sie die ▲/▼-Tasten, um die Option auszuwählen, und drücken Sie die OK-Taste, um das Untermenü aufzurufen.

DISPLAY & TON

Menü -> Einstellungen -> Display & Sound (Display & Klang).

In diesem Menü können Sie die Bild-, Ton- und Audioausgabe des Fernsehgeräts anpassen.

1. Verwenden Sie die ▲/▼-Tasten, um die Einstellung auszuwählen, die Sie anpassen möchten.

2. Drücken Sie dann die OK-Taste, um Ihre Auswahl zu bestätigen.
3. Sind Sie mit den Einstellungen zufrieden und möchten in das vorherige Menü zurückkehren, drücken Sie die ZURÜCK-Taste.

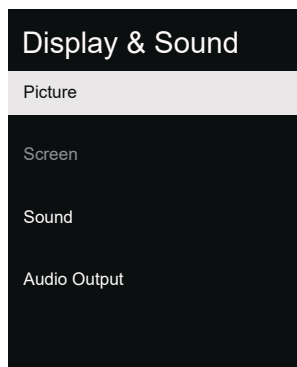

BILD

Menü -> Einstellungen -> Display & Sound (Display & Klang) -> Picture (Bild).

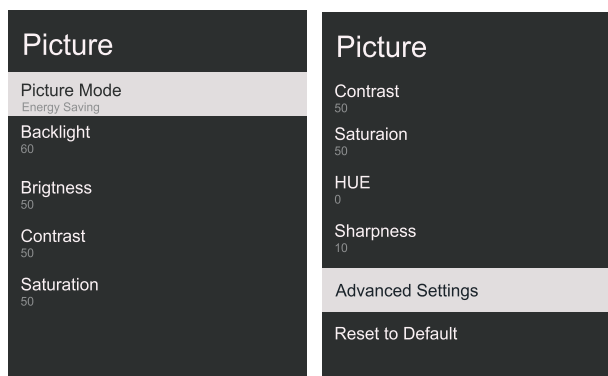

Picture Mode (Bildmodus)

– Verwenden Sie die ▲/▼-Tasten, um die Option auszuwählen, und drücken Sie die OK-Taste, um das Untermenü aufzurufen.

(Zur Auswahl stehen Ihnen die folgenden Optionen: User (Benutzerdefiniert), Standard (Standard), Vivid (Lebendig), Sport (Sport), Movie (Film), Game (Videospiel), Energy saving (Energiesparen).)

Backlight/Brightness/Contrast/Saturation/HUE/Sharpness (Hintergrundbeleuchtung/Helligkeit/Kontrast/Sättigung/Farbtone/Schärfe) – Verwenden Sie die ▲/▼-Tasten, um die gewünschte Option auszuwählen, und bestätigen Sie Ihre Auswahl durch Drücken der OK-Taste.

Möchten Sie den aktuellen Wert verringern, drücken Sie die ◀-Taste. Möchten Sie den aktuellen Wert erhöhen, drücken Sie die ▶-Taste.

Advanced Settings (Erweiterte Einstellungen) – Verwenden Sie die ▲/▼-Tasten, um die Option auszuwählen, und drücken Sie die OK-Taste, um das Untermenü aufzurufen.

Reset to Default (Werkseinstellungen wiederherstellen) – Wählen Sie diese Option, werden sämtliche Einstellungen des Fernsehgeräts auf den Werkzustand zurückgesetzt.

BEDIENUNGSANLEITUNG

TON

Menü -> Einstellungen -> Display & Sound (Display & Klang) -> Sound (Klang).

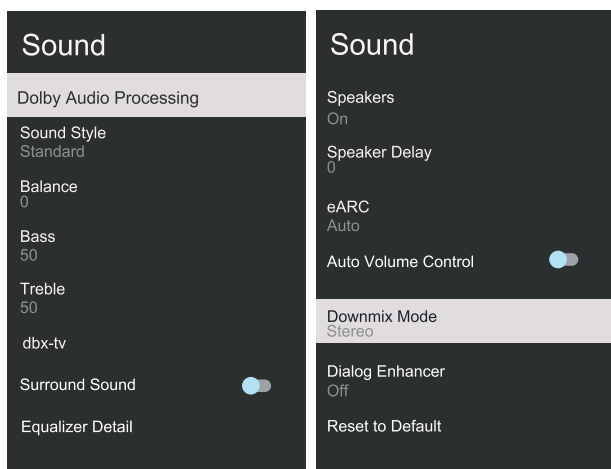

Dolby Audio processing (Dolby Audio-Verarbeitung)

– Verwenden Sie die ▲/▼-Tasten, um die Option auszuwählen, und drücken Sie die OK-Taste, um das Untermenü aufzurufen.

Sound style (Klangbild) – Verwenden Sie die ▲/▼-Tasten, um die Option auszuwählen, und drücken Sie die OK-Taste, um das Untermenü aufzurufen.

(Zur Auswahl stehen Ihnen die folgenden Optionen: User (Benutzerdefiniert), Standard (Standard), Night (Nacht), Sport (Sport), Movie (Film), Music (Musik), News (Nachrichten).)

Balance/Bass/Treble (Balance/Tiefen/Höhen) –

Verwenden Sie die ▲/▼-Tasten, um die gewünschte Option auszuwählen, und drücken Sie die OK-Taste, um Ihre Auswahl zu bestätigen.

Möchten Sie den aktuellen Wert verringern, drücken Sie die ◀-Taste.

Möchten Sie den aktuellen Wert erhöhen, drücken Sie die ▶-Taste.

dbx-tv – Verwenden Sie die ▲/▼-Tasten, um die Option auszuwählen, und drücken Sie die OK-Taste, um das Untermenü aufzurufen.

Surround Sound (Raumklang) – Verwenden Sie die ▲/▼-Tasten, um die Option auszuwählen, und drücken Sie die OK-Taste, um sie zu aktivieren bzw. zu deaktivieren.

Equalizer Detail (Feinabstimmung des Klangbildes) – Verwenden Sie die ▲/▼-Tasten, um die Option auszuwählen, und drücken Sie die OK-Taste, um das Untermenü aufzurufen.

Speakers (Lautsprecher) – Verwenden Sie die ▲/▼-Tasten, um die Option auszuwählen, und drücken Sie die OK-Taste, um sie zu aktivieren bzw. zu deaktivieren.

Speaker Delay (Verzögerung der Lautsprecher) – Verwenden Sie die ▲/▼-Tasten, um die Option auszuwählen, und bestätigen Sie Ihre Auswahl durch Drücken der OK-Taste.

Möchten Sie den aktuellen Wert verringern, drücken Sie die ◀-Taste. Möchten Sie den aktuellen Wert

erhöhen, drücken Sie die ▶-Taste.

eArc – Verwenden Sie die ▲/▼-Tasten, um die Option auszuwählen, und drücken Sie die OK-Taste, um sie zu aktivieren bzw. zu deaktivieren.

Auto Volume Control (Automatische Lautstärkeregelung) – Verwenden Sie die ▲/▼-Tasten, um die Option auszuwählen, und drücken Sie die OK-Taste, um sie zu aktivieren bzw. zu deaktivieren.

Downmix Mode (Modus zum Heruntermischen) – Verwenden Sie die ▲/▼-Tasten, um die Option auszuwählen, und drücken Sie die OK-Taste, um das Untermenü aufzurufen.

(Zur Auswahl stehen Ihnen die folgenden Optionen: Stereo (Stereo), Surround (Raumklang).)

Dialog Enhancer (Dialog-Verstärker) – Verwenden Sie die ▲/▼-Tasten, um die Option auszuwählen, und drücken Sie die OK-Taste, um das Untermenü aufzurufen.

(Zur Auswahl stehen Ihnen die folgenden Optionen: Off (Deaktiviert), Low (Niedrig), Medium (Mittel) und High (Hoch).)

Reset to Default (Werkseinstellungen wiederherstellen) – Wählen Sie diese Option, werden sämtliche Einstellungen des Fernsehgeräts auf den Werkzustand zurückgesetzt.

AUDIOAUSGANG

Menü -> Einstellungen -> Display & Sound (Display & Klang) -> Audio Output (Audioausgang).

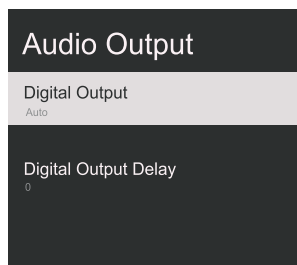

Digital Output (Digitaler Ausgang) – Verwenden Sie die ▲/▼-Tasten, um die Option auszuwählen, und drücken Sie die OK-Taste, um das Untermenü aufzurufen. (Zur Auswahl stehen Ihnen die folgenden Optionen: Auto (Auto), Bypass (Umgehung), PCM, Dolby Digital Plus und Dolby Audio-Dolby Digital.)

Digital Output Delay (Verzögerung des digitalen Audioausgangs) – Verwenden Sie die ▲/▼-Tasten, um die Option auszuwählen, und bestätigen Sie Ihre Auswahl durch Drücken der OK-Taste.

Möchten Sie den aktuellen Wert verringern, drücken Sie die ◀-Taste.

Möchten Sie den aktuellen Wert erhöhen, drücken Sie die ▶-Taste.

NETZWERK

Menü -> Einstellungen -> Network & Internet (Netzwerk & Internet).

BEDIENUNGSANLEITUNG

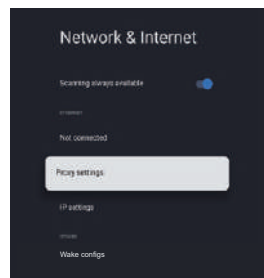
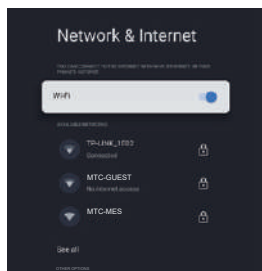

1. Verwenden Sie die ▲/▼-Tasten, um die Einstellung auszuwählen, die Sie anpassen möchten.
2. Drücken Sie dann die OK-Taste, um Ihre Auswahl zu bestätigen.
3. Möchten Sie die Einstellungen speichern und in das vorherige Menü zurückkehren, drücken Sie die OK-Taste erneut.

KONTEN & ANMELDEN

1. Menü -> Einstellungen -> Accounts & sign-in (Benutzerkonten & Anmeldung).
2. Verwenden Sie bei aufgerufener Startansicht die ▲/▼-Tasten, um die Option „Set up Google TV (Einrichtung von Google TV)“ auszuwählen, und fahren Sie fort.

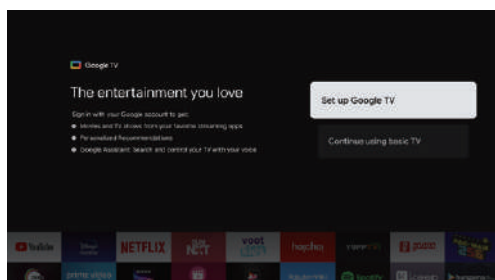

Geben Sie dann den Namen und das Passwort Ihres Benutzerkontos ein. Folgen Sie anschließend den Bildschirmanweisungen, um die entsprechenden Einstellungen vorzunehmen.

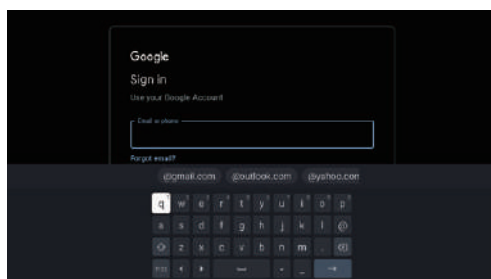

PRIVACY (DATENSCHUTZ)

Menü -> Einstellungen -> Privacy (Datenschutz).

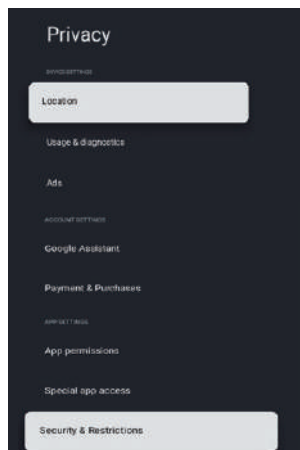

In diesem Menü können Sie den Standort, die Verwendung & Diagnose usw. des Fernsehgeräts einstellen.

1. Verwenden Sie die ▲/▼-Tasten, um die Einstellung auszuwählen, die Sie anpassen möchten.
2. Drücken Sie dann die OK-Taste, um Ihre Auswahl zu bestätigen.
3. Sind Sie mit den Einstellungen zufrieden und möchten in das vorherige Menü zurückkehren, drücken Sie die ZURÜCK-Taste.

STANDORT

Menü -> Einstellungen -> Privacy (Datenschutz) -> Location (Standort).

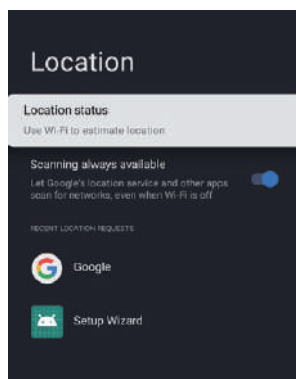

Location status (Status der Standortermittlung)

– Verwenden Sie die ▲/▼-Tasten, um die Option auszuwählen, und drücken Sie die OK-Taste, um das Untermenü aufzurufen.

(Zur Auswahl stehen Ihnen die folgenden Optionen: Use Wi-Fi to estimate location (WLAN zur groben Standortbestimmung nutzen, Off (Aus).)

Scanning always available (Scannen jederzeit möglich)

– Verwenden Sie die ▲/▼-Tasten, um die Option auszuwählen, und drücken Sie die OK-Taste, um sie zu aktivieren bzw. zu deaktivieren.

VERWENDUNG & DIAGNOSE

Menü -> Einstellungen -> Privacy (Datenschutz) -> Usage & diagnostics (Verwendung & Diagnose).

BEDIENUNGSANLEITUNG

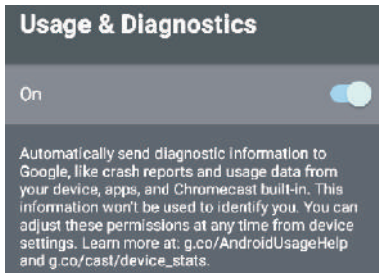

Usage & diagnostics (Verwendung & Diagnose)
– Verwenden Sie die ▲/▼-Tasten, um die Option auszuwählen, und drücken Sie die OK-Taste, um sie zu aktivieren bzw. zu deaktivieren.

APPS

Menü -> Einstellungen -> Apps.

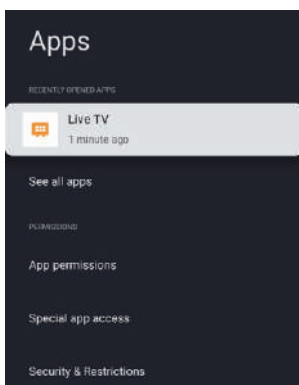

In diesem Menü können Sie die Berechtigungen, die Sie Apps erteilt haben, konfigurieren und Listen der entsprechenden Apps aufrufen.

1. Verwenden Sie die ▲/▼-Tasten, um die Einstellung auszuwählen, die Sie anpassen möchten.
2. Drücken Sie dann die OK-Taste, um Ihre Auswahl zu bestätigen.
3. Sind Sie mit den Einstellungen zufrieden und möchten in das vorherige Menü zurückkehren, drücken Sie die ZURÜCK-Taste.

SYSTEM

Menü -> Einstellungen -> System.

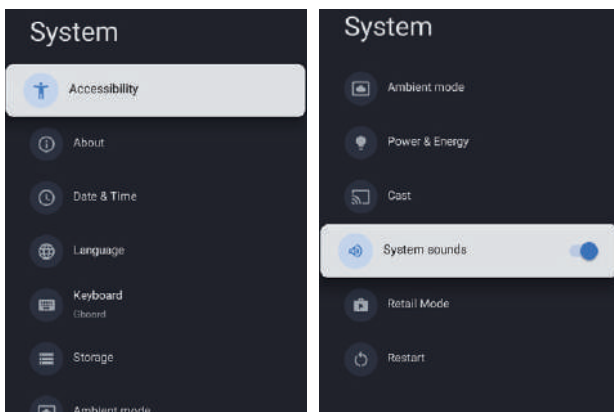

In diesem Menü können Sie die Informationen und Systemeinstellungen des Fernsehgeräts aufrufen und anpassen.

1. Verwenden Sie die ▲/▼-Tasten, um die Einstellung auszuwählen, die Sie anpassen möchten.
2. Drücken Sie dann die OK-Taste, um Ihre Auswahl zu bestätigen.
3. Sind Sie mit den Einstellungen zufrieden und möchten in das vorherige Menü zurückkehren, drücken Sie die ZURÜCK-Taste.

System sounds (Systemtöne) – Verwenden Sie die ▲/▼-Tasten, um die Option auszuwählen, und drücken Sie die OK-Taste, um sie zu aktivieren bzw. zu deaktivieren.

Weitere Informationen zu diesem System finden Sie im nächsten Abschnitt.

ZUGÄNLICHKEIT

Menü -> Einstellungen -> System -> Accessibility (Barrierefreiheit).

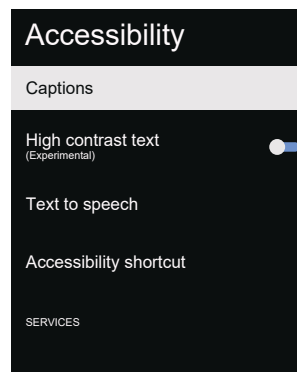

Captions (Untertitel) – Verwenden Sie die ▲/▼-Tasten, um die Option auszuwählen, und drücken Sie die OK-Taste, um das Untermenü aufzurufen.

High contrast text (Text mit hohem Kontrast) – Verwenden Sie die ▲/▼-Tasten, um die Option auszuwählen, und drücken Sie die OK-Taste, um sie zu aktivieren bzw. zu deaktivieren.

Text to speech (Text in Sprache) – Verwenden Sie die ▲/▼-Tasten, um die Option auszuwählen, und drücken Sie die OK-Taste, um das Untermenü aufzurufen.

Accessibility shortcut (Tastenkürzel für Barrierefreiheit) – Verwenden Sie die ▲/▼-Tasten, um die Option auszuwählen, und drücken Sie die OK-Taste, um das Untermenü aufzurufen.

ÜBER

Menü -> Einstellungen -> System -> About (Informationen).

BEDIENUNGSANLEITUNG

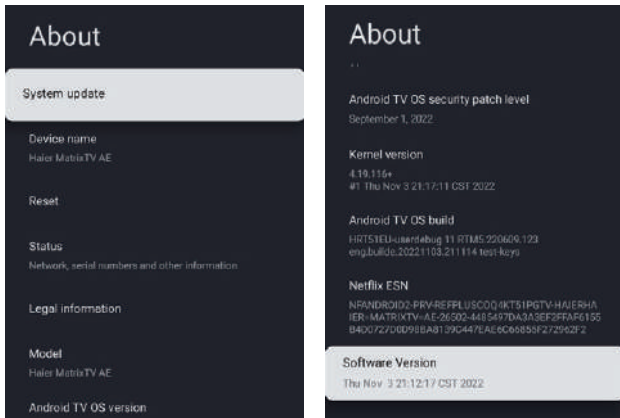

In diesem Menü haben Sie die Möglichkeit, die Firmware des Systems zu aktualisieren oder zurückzusetzen und die Informationen des Fernsehgeräts einzusehen.

1. Verwenden Sie die ▲/▼-Tasten, um die Einstellung auszuwählen, die Sie anpassen möchten.
2. Drücken Sie dann die OK-Taste, um Ihre Auswahl zu bestätigen.
3. Sind Sie mit den Einstellungen zufrieden und möchten in das vorherige Menü zurückkehren, drücken Sie die ZURÜCK-Taste.

DATE&TIME (DATUM & UHRZEIT)

Menü -> Einstellungen -> System -> Date & Time (Datum & Uhrzeit).

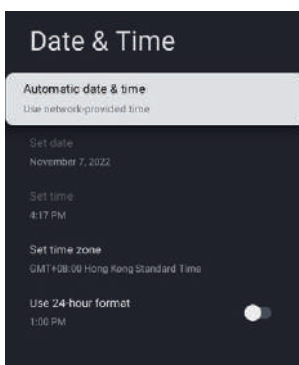

Automatic date & time (Automatische Datums- und Uhrzeiteinstellung) – Verwenden Sie die ▲/▼-Tasten, um die Option auszuwählen, und drücken Sie die OK-Taste, um das Untermenü aufzurufen.

(Zur Auswahl stehen Ihnen die folgenden Optionen: Use network-provided time (Vom Netzwerk bereitgestellte Zeit nutzen), Off (Aus).)

HINWEIS

- Wenn Sie für „Autom. Datum und Uhrzeit“ (Automatic date & time) „AUS“ (OFF) auswählen, können Sie das Datum und die Uhrzeit manuell eingeben.

Set date (Einstellen des Datums) – Verwenden Sie die ▲/▼-Tasten, um die Option auszuwählen,

und drücken Sie die OK-Taste, um das Untermenü aufzurufen.

Set time (Einstellen der Uhrzeit) – Verwenden Sie die ▲/▼-Tasten, um die Option auszuwählen, und drücken Sie die OK-Taste, um das Untermenü aufzurufen.

Set time zone (Festlegen der Zeitzone) – Verwenden Sie die ▲/▼-Tasten, um die Option auszuwählen, und drücken Sie die OK-Taste, um das Untermenü aufzurufen.

Use 24-hour format (24-Stunden-Format verwenden) – Verwenden Sie die ▲/▼-Tasten, um die Option auszuwählen, und drücken Sie die OK-Taste, um sie zu aktivieren bzw. zu deaktivieren.

SPRACHE

Menü -> Einstellungen -> System -> Language (Sprache).

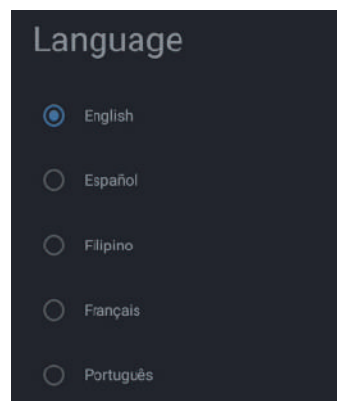

Language (Sprache) – Verwenden Sie die ▲/▼-Tasten, um die Option auszuwählen, navigieren Sie zur gewünschten Sprache und bestätigen Sie Ihre Auswahl durch Drücken der OK-Taste.

TASTATUR

Menü -> Einstellungen -> System -> Keyboard (Tastatur).

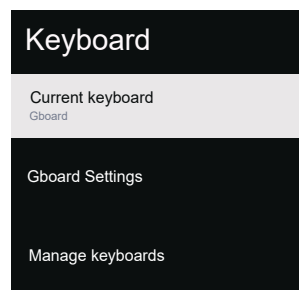

Current keyboard (Aktuelle Tastatur) – Verwenden Sie die ▲/▼-Tasten, um die Option auszuwählen, und drücken Sie die OK-Taste, um das Untermenü aufzurufen.

Gboard Settings (Gboard-Einstellungen) – Verwenden Sie die ▲/▼-Tasten, um die Option auszuwählen, und drücken Sie die OK-Taste, um das Untermenü aufzurufen.

BEDIENUNGSANLEITUNG

Manage keyboards (Tastaturen verwalten) –

Verwenden Sie die ▲/▼-Tasten, um die Option auszuwählen, und drücken Sie die OK-Taste, um das Untermenü aufzurufen.

SPEICHER

Menü -> Einstellungen -> System -> Storage (Speicher).

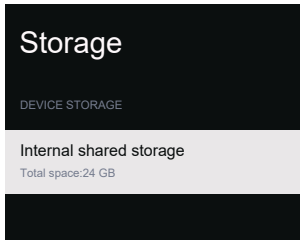

Internal shared storage (Interner gemeinsamer Speicher) – Verwenden Sie die ▲/▼-Tasten, um die Option auszuwählen, und drücken Sie die OK-Taste, um das Untermenü aufzurufen.

AMBIENT MODE (BILDSCHIRMSCHONER)

Menü -> Einstellungen -> System -> Ambient mode (Bildschirmschoner).

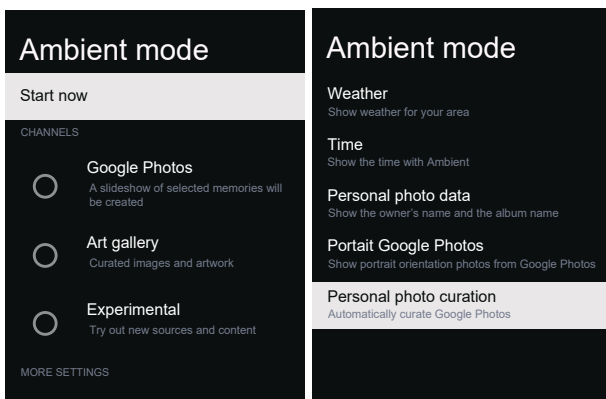

In diesem Menü können Sie den Bildschirmschoner aktivieren und entsprechende Einstellungen vornehmen.

1. Verwenden Sie die ▲/▼-Tasten, um die Einstellung auszuwählen, die Sie anpassen möchten.
2. Drücken Sie dann die OK-Taste, um Ihre Auswahl zu bestätigen.
3. Sind Sie mit den Einstellungen zufrieden und möchten in das vorherige Menü zurückkehren, drücken Sie die ZURÜCK-Taste.

POWER & ENERGY (LEISTUNGS-AUFNAHME & ENERGIESPAREN)

Menü -> Einstellungen -> System -> Power & Energy (Leistungsaufnahme & Energiesparen).

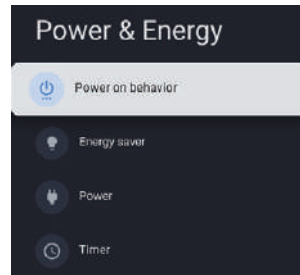

In diesem Menü können Sie die Leistungsaufnahme des Fernsehgeräts anpassen und den Energiesparbetrieb aktivieren. (Zur Auswahl stehen Ihnen die folgenden Optionen: Power on behavior (Einschaltverhalten), Energy saver (Energiesparbetrieb), Power (Leistungsaufnahme) und Timer (Timer).)

1. Verwenden Sie die ▲/▼-Tasten, um die Einstellung auszuwählen, die Sie anpassen möchten.
2. Drücken Sie dann die OK-Taste, um Ihre Auswahl zu bestätigen.
3. Sind Sie mit den Einstellungen zufrieden und möchten in das vorherige Menü zurückkehren, drücken Sie die ZURÜCK-Taste.

POWER ON BEHAVIOR (EINSCHALTVERHALTEN)

Menü -> Einstellungen -> System -> Power & Energy (Leistungsaufnahme & Energiesparen) -> Power on behavior (Einschaltverhalten).

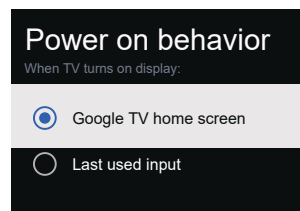

Verwenden Sie die ▲/▼-Tasten, um die Option auszuwählen, und bestätigen Sie Ihre Auswahl durch Drücken der OK-Taste.

ENERGIESPAREN

Menü -> Einstellungen -> System -> Power & Energy (Leistungsaufnahme & Energiesparen) -> Energy Saver (Energiesparbetrieb).

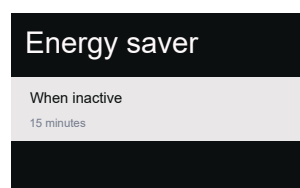

When inactive (Bei Inaktivität) – Verwenden Sie die ▲/▼-Tasten, um die Option auszuwählen, und drücken Sie die OK-Taste, um das Untermenü aufzurufen.

(Zur Auswahl stehen Ihnen die folgenden Optionen: 15 minutes (15 Minuten), 20 minutes (20 Minuten),

BEDIENUNGSANLEITUNG

30 minutes (30 Minuten), 1 hour (1 Stunde), 4 hours (4 Stunden), 8 hours (8 Stunden), 12 hours (12 Stunden), 24 hours (24 Stunden) und Never (Nie.)

STROM

Menü -> Einstellungen -> System -> Power & Energy (Leistungsaufnahme & Energiesparen) -> Power (Leistungsaufnahme).

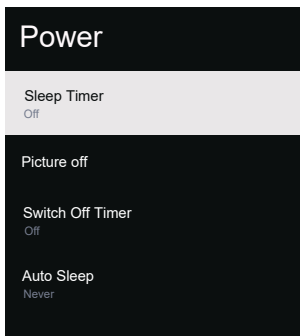

Sleep Timer (Schlaf-Timer) – Verwenden Sie die ▲/▼-Tasten, um die Option auszuwählen, und drücken Sie die OK-Taste, um das Untermenü aufzurufen.

(Zur Auswahl stehen Ihnen die folgenden Optionen: Off (Aus), 10 minutes (10 Minuten), 20 minutes (20 Minuten), 30 minutes (30 Minuten), 40 minutes (40 Minuten), 50 minutes (50 Minuten), 60 minutes (60 Minuten), 90 minutes (90 Minuten) und 120 minutes (120 Minuten).)

Picture off (Bildschirm abdunkeln) – Verwenden Sie die ▲/▼-Tasten, um die Option auszuwählen, und bestätigen Sie Ihre Auswahl durch Drücken der OK-Taste.

Switch off timer (Timer für Abschaltung) – Verwenden Sie die ▲/▼-Tasten, um die Option auszuwählen, und drücken Sie die OK-Taste, um das Untermenü aufzurufen.

(Zur Auswahl stehen Ihnen die folgenden Optionen: Off (Aus), 30 minutes (30 Minuten), 60 minutes (60 Minuten), 90 minutes (90 Minuten), 120 minutes (120 Minuten), 150 minutes (150 Minuten), 180 minutes (180 Minuten), 210 minutes (210 Minuten) und 240 minutes (240 Minuten).)

Auto Sleep (Automatisches Versetzen in den Ruhezustand) – Verwenden Sie die ▲/▼-Tasten, um die Option auszuwählen, und drücken Sie die OK-Taste, um das Untermenü aufzurufen.

(Zur Auswahl stehen Ihnen die folgenden Optionen: Never (Nie), 4 hours (4 Stunden), 6 hours (6 Stunden) und 8 hours (8 Stunden).)

TIMER

Menü -> Einstellungen -> System -> Power & Energy (Leistungsaufnahme & Energiesparen) -> Timer (Timer).

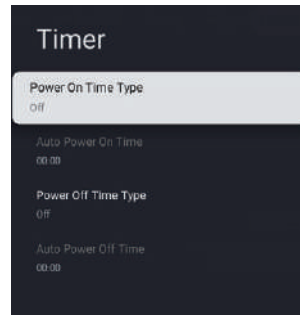

Power On Time Type (Status der automatischen Inbetriebnahme) – Verwenden Sie die ▲/▼-Tasten, um die Option auszuwählen, und drücken Sie die OK-Taste, um sie zu deaktivieren, zu aktivieren oder einmal zu aktivieren.

Auto Power On Time (Zeitpunkt der automatischen Inbetriebnahme) – Verwenden Sie die ▲/▼-Tasten, um die Option auszuwählen, und drücken Sie die OK-Taste, um das Untermenü aufzurufen.

Power Off Time Type (Status der automatischen Abschaltung) – Verwenden Sie die ▲/▼-Tasten, um die Option auszuwählen, und drücken Sie die OK-Taste, um sie zu deaktivieren, zu aktivieren oder einmal zu aktivieren.

Auto Power Off Time (Zeitpunkt der automatischen Abschaltung) – Verwenden Sie die ▲/▼-Tasten, um die Option auszuwählen, und drücken Sie die OK-Taste, um das Untermenü aufzurufen.

CAST (SPIEGELUNG)

Menü -> Einstellungen -> System -> Cast (Spiegelung).

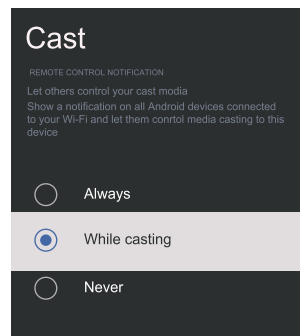

1. Verwenden Sie die ▲/▼-Tasten, um die Einstellung auszuwählen, die Sie anpassen möchten.
2. Drücken Sie dann die OK-Taste, um Ihre Auswahl zu bestätigen.
3. Möchten Sie in das vorherige Menü zurückkehren, drücken Sie die ZURÜCK-Taste.

RETAIL MODE (BETRIEBSART FÜR DEN HANDEL)

Menü -> Einstellungen -> System -> Retail Mode (Betriebsart für den Handel).

BEDIENUNGSANLEITUNG

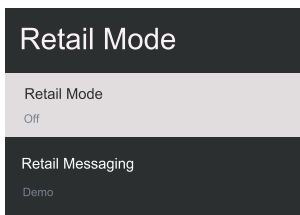

Retail mode (Betriebsart für den Handel) –
Verwenden Sie die ▲/▼-Tasten, um die Option auszuwählen, und drücken Sie die OK-Taste, um sie zu aktivieren bzw. zu deaktivieren.

Retail messaging (Bildschirminhalt für den Handel)
– Verwenden Sie die ▲/▼-Tasten, um die Option auszuwählen, und drücken Sie die OK-Taste, um das Untermenü aufzurufen. (Hinweis: Demo, e-POP, e-POP +Demo (e-POP + Demo).)

RESTART (NEUSTART)

Menü -> Einstellungen -> System -> Restart (Neustart).

Drücken Sie die OK-Taste, um das Untermenü aufzurufen.

(Zur Auswahl stehen Ihnen die folgenden Optionen: Restart (Neustart) und Cancel (Abbrechen).)

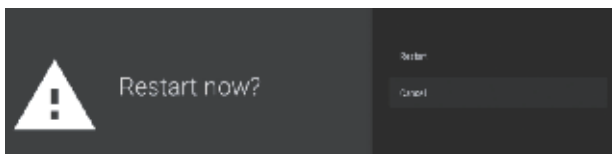

FERNBEDIENUNGEN & ZUBEHÖR

Menü -> Einstellungen -> Remotes & Accessories (Fernbedienungen & Zubehör).

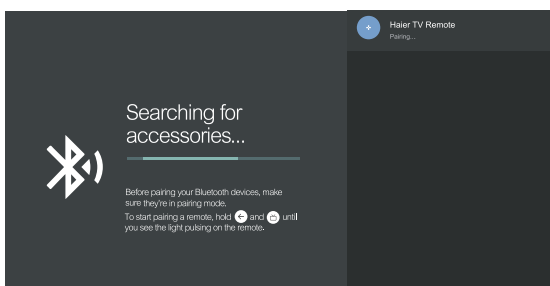
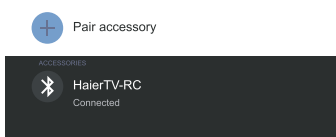

In diesem Menü können Sie Bluetooth-Geräte mit dem Fernsehgerät koppeln.

1. Halten Sie zunächst einmal die sich unten auf der Fernbedienung befindlichen Tasten „←“ und „TV“ fünf Sekunden lang gedrückt.
2. Lassen Sie die Tasten wieder los, sobald die LED zu blinken beginnt. Die Fernbedienung sendet daraufhin das Signal zur Kopplung an das

Fernsehgerät und zeigt Ihnen die Informationen der Fernbedienung auf der rechten Seite des Bildschirms an.

3. Drücken Sie dann die OK-Taste, um den Beginn des Kopplungsvorgangs einzuleiten. War die Kopplung erfolgreich, wird Ihnen die Meldung „paired (gekoppelt)“ eingeblendet.
4. Ist die Kopplung fehlgeschlagen, wird Ihnen die Meldung „couldn't pair (Kopplung nicht möglich)“ eingeblendet. Sollte der Kopplungsvorgang fehlschlagen, halten Sie die sich unten auf der Fernbedienung befindlichen Tasten „←“ und „TV“ erneut fünf Sekunden lang gedrückt und wiederholen Sie die oben aufgeführten Schritte.
5. Drücken Sie anschließend die ←-Taste, um zum vorherigen Menü zurückzukehren.

VERWENDEN DES MULTIMEDIA-PLAYERS

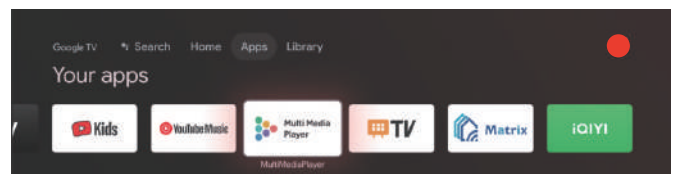

1. Verwenden Sie bei aufgerufener Startansicht oder in der Ansicht mit den Apps die ▲/▼/◀/▶-Tasten, um die Anwendung des Multimedia-Players auszuwählen.

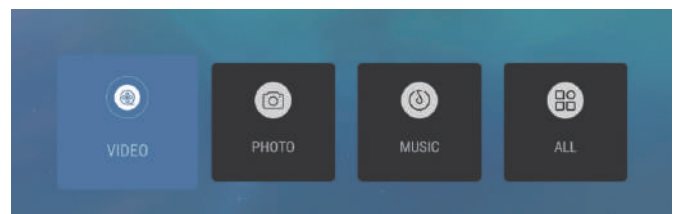

2. Drücken Sie dann die OK-Taste, um die Anwendung des Multimedia-Players zu starten und Video-, Foto- oder Audio-Dateien wiederzugeben bzw. anzuzeigen. Nachdem Sie einen USB-Datenträger angeschlossen haben, können Sie die darauf gespeicherten Dateien (FAT32-Format) abrufen.

HINWEIS

Je nachdem, wann Sie das Fernsehgerät erworben haben, kann das Erscheinungsbild des Menüs Unterschiede aufweisen.

PROBLEMLÖSUNGEN

Wenden Sie stets zuerst die nachstehend aufgeführten Abhilfemaßnahmen an, bevor Sie sich mit dem Kundendienst in Verbindung setzen. So sparen Sie Zeit und Geld, denn die Kosten für die Einrichtung des Fernsehgeräts und die Einstellung der kundenseitigen Bedienelemente fallen nicht unter die Garantie.

Symptome	Mögliche Ursachen und einzuleitende Abhilfemaßnahmen
Doppelbild (ugs. Geisterbild)	<ul style="list-style-type: none"> Dies kann durch die Behinderung der Antenne durch hohe Gebäude oder Hügel verursacht werden. Verwenden Sie eine hoch direktionale Antenne, um das Bild zu verbessern.
Stromversorgung unterbrochen	<ul style="list-style-type: none"> Überprüfen Sie, ob das Netzkabel des Fernsehgeräts ordnungsgemäß an die Netzsteckdose angeschlossen ist. Trennen Sie das Fernsehgerät von der Stromversorgung und warten Sie 60 Sekunden. Schließen Sie dann den Netzstecker wieder an die Netzsteckdose an und schalten Sie das Fernsehgerät ein.
Kein Bild	<ul style="list-style-type: none"> Überprüfen Sie die Antennenanschlüsse an der Rückblende des Fernsehgeräts, und stellen Sie sicher, dass die Antenne ordnungsgemäß an das Fernsehgerät angeschlossen ist. Die Übertragung des Fernsehsenders ist möglicherweise gestört. Versuchen Sie es mit einem anderen Sender. Passen Sie die Einstellungen für Kontrast und Helligkeit an. Überprüfen Sie die auf die Untertitel bezogenen Einstellungen. Einige Texte verdecken möglicherweise den Bildschirminhalt.
Gute Bildqualität, aber keine Tonausgabe	<ul style="list-style-type: none"> Drücken Sie die sich auf der Fernbedienung befindliche STUMMSCHALT-Taste, um sicherzustellen, dass die Stummschaltung deaktiviert ist.
Guter Klang, aber schlechte Farbdarstellung	<ul style="list-style-type: none"> Passen Sie die Einstellungen für Kontrast, Farbton und Helligkeit an.
Schlechte Bildqualität	<ul style="list-style-type: none"> Eine schlechte Bildqualität kann die Folge einer sich in Betrieb befindlichen S-VHS-Kamera oder eines Camcorders, die bzw. der gleichzeitig mit anderen Peripheriegeräten an das Fernsehgerät angeschlossen ist, sein. Schalten Sie eines der anderen Peripheriegeräte aus.
Verrauschtes/Gestörtes Bild	<ul style="list-style-type: none"> Überprüfen Sie den Anschluss der Antenne.
Horizontale gepunktete Linie	<ul style="list-style-type: none"> Dies kann durch elektrische Störungen verursacht werden (z. B. Haartrockner, Neonleuchten in der Nähe usw.). Schalten Sie das für die Störung verantwortliche Gerät aus.
Fernsehgerät reagiert nicht auf Befehle der Fernbedienung	<ul style="list-style-type: none"> Überprüfen Sie, ob die Batterien noch genügend Spannung haben. Sollte dies nicht der Fall sein, ersetzen Sie die Batterien durch neue. Reinigen Sie die Linse des sich an dem Fernsehgerät befindlichen Fernbedienungssensors.
Pixel (Punkte), die stets dunkel oder stets hell sind	<ul style="list-style-type: none"> Ihr Fernsehgerät ist ein präzise gefertigtes Produkt auf höchstem technischen Niveau. Es kann jedoch vorkommen, dass Pixel nicht korrekt angezeigt werden. Diese Art von Darstellungsfehlern ist bei dieser Produktgattung üblich und weist nicht auf einen Defekt hin.

HINWEIS

- Bei diesem Produkt kommt ein aus Subpixeln bestehendes Panel zum Einsatz, dessen Herstellung die Anwendung anspruchsvoller Technologien voraussetzt. Dies bedeutet jedoch nicht, dass das Erscheinen einiger heller oder dunkler Pixel auf dem Bildschirm gänzlich ausgeschlossen ist. Die Leistung des Produkts wird durch diese Pixel nicht beeinträchtigt.



Die Begriffe HDMI, HDMI High-Definition Multimedia Interface, HDMI Trade Dress und die HDMI-Logos sind Handelsnamen oder eingetragene Markenzeichen der HDMI Licensing Administrator, Inc.



Dolby, Dolby Vision, Dolby Atmos, Dolby Audio und das Doppel-D-Symbol sind Marken der Dolby Laboratories Licensing Corporation. Hergestellt unter Lizenz von Dolby Laboratories. Vertrauliche unveröffentlichte Arbeiten. Copyright ©2012-2024 – Dolby Laboratories. Alle Rechte vorbehalten.

TECHNISCHE DATEN

43" UHD LED-Fernsehgerät

Bildqualität und relevante Parameter	UHD Integriertes Display Größe des Displays: 108 cm Auflösung: 3840 x 2160 Pixel bei 60 Hz
System der Farbübertragung	PAL-B/G, SECAM-B/G
Übertragung digitaler Signale (DTV)	DVB-T, DVB-C, DVB-T2, DVB-S2 16/32/64/128/256 QAM-Modulation MPEG2, MPEG4, H.265
Konnektivität	1 x optischer Anschluss 2 x USB-Anschluss 1 x LAN-Anschluss 4 x HDMI-Anschluss 1 x VIDEO-Anschluss 1 x L-Buchse 1 x R-Buchse 2 x RF-Buchse 1 x Kopfhörerbuchse (EARPHONE) 1 x CI-Schnittstelle Unterstützte Farbübertragungssysteme: PAL + SECAM Anzahl der Sendepunkte: 1000 (DTV), 100 (ATV) TV (RF): 75 Ω Missverhältnis AV-Video-Eingang: 75 Ω, 1V-P, RCA AV-Audio-Eingang: 20 kΩ, 500 mV (Effektivwert) HDMI-Video-Eingang: 480i, 480p, 720p, 1080i, 1080p, 2160p WLAN: Standard: IEEE 802.11a/b/g/n/ac, Frequenzband: 2,4 GHz/5 GHz Bluetooth: V5.1
Klangqualität	Stereo-Sound-System Ausgangsleistung: 2 x 10 W (Effektivwert)
Leistungsaufnahme im Standby-Modus	≤0,5 W
Digitale Funktionen	Digitale Interaktivität Digitaler Text Untertitel bei digitaler Videoübertragung (DVB) verfügbar Automatische Einrichtung Automatischer Sendersuchlauf Anzeige des aktuellen und darauffolgenden Fernsehprogramms Elektronischer Programmführer (EPG) für 7 Tage CI-Schlitz. Mit Audiodeskription kompatibel
Weitere Funktionen und Merkmale	UHF/VHF-Tuner, Sleep-Timer, Kindersicherung, Bild und Text Fernbedienung (benötigt 2 Batterien des Typs AAA) Abmessungen der VESA-Halterung: 300 x 300 mm Abmessungen der Verpackung (B x H x T): 1075 x 652 x 142 mm Abmessungen des Produkts mit Standfuß (B x H x T): 957,2 x 607,4 x 240,7 mm Abmessungen des Produkts ohne Standfuß (B x H x T): 957,2 x 566,7 x 86,6 mm Gewicht der Verpackung: 10 kg Gewicht des Produkts mit Standfuß: 7,2 kg Gewicht des Produkts ohne Standfuß: 6,8 kg

*Die hier zu diesem Fernsehgerät angegebenen technischen Daten dienen lediglich als Referenz. Abweichungen sind aufgrund der regelmäßigen Aktualisierung der Produkttechnik möglich. Änderungen am Design und an den Spezifikationen ohne vorherige Ankündigung vorbehalten.

TECHNISCHE DATEN

50" UHD LED-Fernsehgerät

Bildqualität und relevante Parameter	UHD Integriertes Display Größe des Displays: 126 cm Auflösung: 3840 x 2160 Pixel bei 60 Hz
System der Farbübertragung	PAL-B/G, SECAM-B/G
Übertragung digitaler Signale (DTV)	DVB-T, DVB-C, DVB-T2, DVB-S2 16/32/64/128/256 QAM-Modulation MPEG2, MPEG4, H.265
Konnektivität	1 x optischer Anschluss 2 x USB-Anschluss 1 x LAN-Anschluss 4 x HDMI-Anschluss 1 x VIDEO-Anschluss 1 x L-Buchse 1 x R-Buchse 2 x RF-Buchse 1 x Kopfhörerbuchse (EARPHONE) 1 x CI-Schnittstelle Unterstützte Farbübertragungssysteme: PAL + SECAM Anzahl der Sendepplätze: 1000 (DTV), 100 (ATV) TV (RF): 75 Ω Missverhältnis AV-Video-Eingang: 75 Ω, 1V-P, RCA AV-Audio-Eingang: 20 kΩ, 500 mV (Effektivwert) HDMI-Video-Eingang: 480i, 480p, 720p, 1080i, 1080p, 2160p WLAN: Standard: IEEE 802.11a/b/g/n/ac, Frequenzband: 2,4 GHz/5 GHz Bluetooth: V5.1
Klangqualität	Stereo-Sound-System Ausgangsleistung: 2 x 13.5 W (Effektivwert)
Leistungsaufnahme im Standby-Modus	≤0,5 W
Digitale Funktionen	Digitale Interaktivität Digitaler Text Untertitel bei digitaler Videoübertragung (DVB) verfügbar Automatische Einrichtung Automatischer Sendersuchlauf Anzeige des aktuellen und darauffolgenden Fernsehprogramms Elektronischer Programmführer (EPG) für 7 Tage CI-Schlitz. Mit Audiodeskription kompatibel
Weitere Funktionen und Merkmale	UHF/VHF-Tuner, Sleep-Timer, Kindersicherung, Bild und Text Fernbedienung (benötigt 2 Batterien des Typs AAA) Abmessungen der VESA-Halterung: 300 x 300 mm Abmessungen der Verpackung (B x H x T): 1250 x 760 x 144 mm Abmessungen des Produkts mit Standfuß (B x H x T): 1111,2 x 710,5 x 277,2 mm Abmessungen des Produkts ohne Standfuß (B x H x T): 1111,2 x 651,8 x 88 mm Gewicht der Verpackung: 13,5 kg Gewicht des Produkts mit Standfuß: 10 kg Gewicht des Produkts ohne Standfuß: 9,5 kg

*Die hier zu diesem Fernsehgerät angegebenen technischen Daten dienen lediglich als Referenz. Abweichungen sind aufgrund der regelmäßigen Aktualisierung der Produkttechnik möglich. Änderungen am Design und an den Spezifikationen ohne vorherige Ankündigung vorbehalten.

TECHNISCHE DATEN

55" UHD LED-Fernsehgerät

Bildqualität und relevante Parameter	UHD Integriertes Display Größe des Displays: 139 cm Auflösung: 3840 x 2160 Pixel bei 60 Hz
System der Farbübertragung	PAL-B/G, SECAM-B/G
Übertragung digitaler Signale (DTV)	DVB-T, DVB-C, DVB-T2, DVB-S2 16/32/64/128/256 QAM-Modulation MPEG2, MPEG4, H.265
Konnektivität	1 x optischer Anschluss 2 x USB-Anschluss 1 x LAN-Anschluss 4 x HDMI-Anschluss 1 x VIDEO-Anschluss 1 x L-Buchse 1 x R-Buchse 2 x RF-Buchse 1 x Kopfhörerbuchse (EARPHONE) 1 x CI-Schnittstelle Unterstützte Farbübertragungssysteme: PAL + SECAM Anzahl der Sendepunkte: 1000 (DTV), 100 (ATV) TV (RF): 75 Ω Missverhältnis AV-Video-Eingang: 75 Ω, 1V-P, RCA AV-Audio-Eingang: 20 kΩ, 500 mV (Effektivwert) HDMI-Video-Eingang: 480i, 480p, 720p, 1080i, 1080p, 2160p WLAN: Standard: IEEE 802.11a/b/g/n/ac, Frequenzband: 2,4 GHz/5 GHz Bluetooth: V5.1
Klangqualität	Stereo-Sound-System Ausgangsleistung: 2 x 13,5 W (Effektivwert)
Leistungsaufnahme im Standby-Modus	≤0,5 W
Digitale Funktionen	Digitale Interaktivität Digitaler Text Untertitel bei digitaler Videoübertragung (DVB) verfügbar Automatische Einrichtung Automatischer Sendersuchlauf Anzeige des aktuellen und darauffolgenden Fernsehprogramms Elektronischer Programmführer (EPG) für 7 Tage CI-Schlitz. Mit Audiodeskription kompatibel
Weitere Funktionen und Merkmale	UHF/VHF-Tuner, Sleep-Timer, Kindersicherung, Bild und Text Fernbedienung (benötigt 2 Batterien des Typs AAA) Abmessungen der VESA-Halterung: 300 x 300 mm Abmessungen der Verpackung (B x H x T): 1350 x 837 x 144 mm Abmessungen des Produkts mit Standfuß (B x H x T): 1225,8 x 777,3 x 277,2 mm Abmessungen des Produkts ohne Standfuß (B x H x T): 1225,8 x 719,4 x 88,1 mm Gewicht der Verpackung: 16,4 kg Gewicht des Produkts mit Standfuß: 11,9 kg Gewicht des Produkts ohne Standfuß: 11,4 kg

*Die hier zu diesem Fernsehgerät angegebenen technischen Daten dienen lediglich als Referenz. Abweichungen sind aufgrund der regelmäßigen Aktualisierung der Produkttechnik möglich. Änderungen am Design und an den Spezifikationen ohne vorherige Ankündigung vorbehalten.

TECHNISCHE DATEN

65" UHD LED-Fernsehgerät

Bildqualität und relevante Parameter	UHD Integriertes Display Größe des Displays: 164 cm Auflösung: 3840 x 2160 Pixel bei 60 Hz
System der Farbübertragung	PAL-B/G, SECAM-B/G
Übertragung digitaler Signale (DTV)	DVB-T, DVB-C, DVB-T2, DVB-S2 16/32/64/128/256 QAM-Modulation MPEG2, MPEG4, H.265
Konnektivität	1 x optischer Anschluss 2 x USB-Anschluss 1 x LAN-Anschluss 4 x HDMI-Anschluss 1 x VIDEO-Anschluss 1 x L-Buchse 1 x R-Buchse 2 x RF-Buchse 1 x Kopfhörerbuchse (EARPHONE) 1 x CI-Schnittstelle Unterstützte Farbübertragungssysteme: PAL + SECAM Anzahl der Sendepplätze: 1000 (DTV), 100 (ATV) TV (RF): 75 Ω Missverhältnis AV-Video-Eingang: 75 Ω, 1V-P, RCA AV-Audio-Eingang: 20 kΩ, 500 mV (Effektivwert) HDMI-Video-Eingang: 480i, 480p, 720p, 1080i, 1080p, 2160p WLAN: Standard: IEEE 802.11a/b/g/n/ac, Frequenzband: 2,4 GHz/5 GHz Bluetooth: V5.1
Klangqualität	Stereo-Sound-System Ausgangsleistung: 2 x 13,5 W (Effektivwert)
Leistungsaufnahme im Standby-Modus	≤0,5 W
Digitale Funktionen	Digitale Interaktivität Digitaler Text Untertitel bei digitaler Videoübertragung (DVB) verfügbar Automatische Einrichtung Automatischer Sendersuchlauf Anzeige des aktuellen und darauffolgenden Fernsehprogramms Elektronischer Programmführer (EPG) für 7 Tage CI-Schlitz. Mit Audiodeskription kompatibel
Weitere Funktionen und Merkmale	UHF/VHF-Tuner, Sleep-Timer, Kindersicherung, Bild und Text Fernbedienung (benötigt 2 Batterien des Typs AAA) Abmessungen der VESA-Halterung: 400 x 300 mm Abmessungen der Verpackung (B x H x T): 1600 x 960 x 164 mm Abmessungen des Produkts mit Standfuß (B x H x T): 1446,4 x 904,7 x 313,8 mm Abmessungen des Produkts ohne Standfuß (B x H x T): 1446,4 x 841,3 x 85,1 mm Gewicht der Verpackung: 24 kg Gewicht des Produkts mit Standfuß: 17,2 kg Gewicht des Produkts ohne Standfuß: 16,5 kg

*Die hier zu diesem Fernsehgerät angegebenen technischen Daten dienen lediglich als Referenz. Abweichungen sind aufgrund der regelmäßigen Aktualisierung der Produkttechnik möglich. Änderungen am Design und an den Spezifikationen ohne vorherige Ankündigung vorbehalten.

Haier

Haier

Vida inspirada

Manual del usuario

MODELOS:

H43Q80FUX

H50Q80FUX

H55Q80FUX

H65Q80FUX



Las ilustraciones de esta guía se proporcionan únicamente a modo de referencia y podrían diferir del aspecto real del producto. El diseño y las especificaciones del producto pueden variar sin previo aviso.

Televisión LED

ÍNDICE

1. INSTRUCCIONES DE SEGURIDAD IMPORTANTES	1
2. PREPARACIÓN.....	3
3. CONEXIÓN PERIFÉRICA Y CONTROLES.....	4
4. ESTABLECER LAS CONEXIONES	5
5. INSTRUCCIONES DE USO	6
6. RESOLUCIÓN DE PROBLEMAS.....	19
7. ESPECIFICACIONES DEL PRODUCTO	20



Las ilustraciones de esta guía se proporcionan únicamente a modo de referencia y podrían diferir del aspecto real del producto.



El diseño y las especificaciones del producto pueden variar sin previo aviso.

INSTRUCCIONES DE SEGURIDAD IMPORTANTES

- 1) Lea estas instrucciones.
- 2) Conserve estas instrucciones.
- 3) Preste atención a todas las advertencias.
- 4) Siga todas las instrucciones.
- 5) No utilice este aparato cerca del agua.
- 6) Límpielo solo con un paño seco.
- 7) No bloquee ninguna abertura de ventilación, instale de acuerdo con las instrucciones.
- 8) No lo instale cerca de fuentes de calor como radiaciones, rejillas de calefacción, estufas u otros aparatos (incluidos amplificadores) que produzcan calor.
- 9) No anule el dispositivo de seguridad del enchufe polarizado. Si el enchufe suministrado no encaja en su toma de corriente, consulte con un electricista para que sustituya la toma obsoleta.
- 10) Proteja el cable de alimentación para que no se pueda pisar ni pellizcar, especialmente en los enchufes, las tomas de corriente y el punto en el que salen del aparato.
- 11) Utilice únicamente los complementos/accesorios especificados por el fabricante.
- 12) Desenchufe este aparato durante las tormentas eléctricas o cuando no lo vaya a utilizar durante largos periodos de tiempo.
- 13) La reparación del producto deberá ser realizada el personal de servicio técnico calificado. Es necesario reparar el aparato cuando haya sufrido algún tipo de daño, como por ejemplo si el cable de alimentación o el enchufe están dañados, si se ha derramado líquido o han caído objetos dentro del aparato, si ha estado expuesto a la lluvia o la humedad, si no funciona con normalidad o si se ha caído.
- 14) Si se utiliza el enchufe de la corriente como dispositivo de desconexión, debe estar fácilmente accesible.
- 15) No debería impedir la ventilación tapando las aberturas de ventilación con , objetos como periódicos, manteles, cortinas, , etc.
- 16) No debería colocar sobre el aparato llamas desprotegidas, como velas encendidas.
- 17) Se debe prestar atención a los aspectos medioambientales de la eliminación de baterías.
- 18) El uso del aparatos en clima moderado.
- 19) El aparato no deberá exponerse a goteos ni salpicaduras y no se colocarán objetos llenos de líquido, como floreros, sobre él.
- 20) Advertencia: Para evitar cualquier lesión causada por la inclinación del producto, asegúrese siempre de que todo el producto se colocó dentro de la superficie de la mesa en horizontal.

* El producto real puede variar en apariencia con respecto a la imagen superior*

Cuando se utilice un enchufe en el cable de alimentación como dispositivo de desconexión, las instrucciones de instalación indicarán que para los equipos enchufables, la toma de corriente deberá ser fácilmente accesible.

	PRECAUCIÓN RIESGO DE DESCARGA ELÉCTRICA ¡NO ABRIR!	
PRECAUCIÓN PARA REDUCIR EL RIESGO DE DESCARGA ELÉCTRICA, NO RETIRE LA CUBIERTA (NI LA PARTE POSTERIOR). NO HAY PIEZAS REPARABLES POR EL USUARIO EN SU INTERIOR. LA REPARACIÓN DEL PRODUCTO DEBE REALIZARLA EL PERSONAL DE SERVICIO CALIFICADO.		



El símbolo indica que en el interior de esta unidad hay tensiones peligrosas que constituyen un riesgo de descarga eléctrica.



El símbolo indica que hay instrucciones importantes de funcionamiento y mantenimiento en la documentación que acompaña a esta unidad.

ADVERTENCIA:

Para reducir el riesgo o incendio o descarga eléctrica, no exponga este aparato a la lluvia ni a la humedad.

ADVERTENCIA:

No se deben exponer las pilas a una temperatura excesiva, como la luz directa del sol, fuego o similares.



Este símbolo indica que este producto incorpora un doble aislamiento entre la tensión de red peligrosa y las partes accesibles al usuario. Cuando realice el mantenimiento, utilice únicamente piezas de repuesto idénticas.



Esta marca indica que este producto no debe desecharse con otros residuos domésticos. Para evitar posibles daños al medio ambiente o a la salud humana derivados de la eliminación incontrolada de residuos, recíclelos de forma responsable para promover la reutilización sostenible de los recursos materiales. Para devolver su aparato usado, utilice el sistema de devolución y recogida o póngase en contacto con el minorista donde adquirió el producto. Pueden llevarse este producto para reciclarlo de forma segura para el medio ambiente.

INSTRUCCIONES DE SEGURIDAD IMPORTANTES

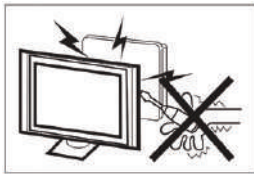

En el funcionamiento de este receptor de televisión se utilizan tensiones elevadas. No retire el respaldo del armario de su aparato. La reparación del producto debe realizarla el personal de servicio calificado.

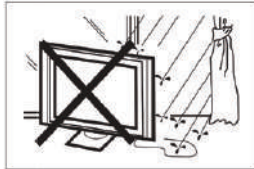

Para evitar incendios o descargas eléctricas, no exponga el receptor de televisión a la lluvia ni a la humedad.



No deje caer ni empuje objetos en las ranuras o aberturas del mueble del televisor. No derrame nunca ningún tipo de líquido sobre el receptor de televisión.



No bloquee los orificios de ventilación de la cubierta trasera. Una ventilación adecuada es esencial para evitar fallos en los componentes eléctricos.



No atrape el cable de alimentación bajo el receptor de televisión.



Si va a limpiar el producto, desenchufe el televisor, utilice un tejido suave, sin agua, nunca productos químicos.



Nunca se ponga de pie, se apoye o empuje bruscamente el televisor o su soporte. Debe prestar especial atención a los niños. Puede sufrir lesiones graves si se cae.

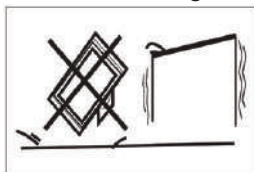

No coloque el televisor sobre un carro, base, estantería o mesa inestable. La caída del televisor puede provocar lesiones graves a una persona y daños al televisor.

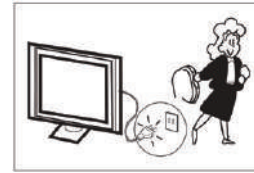

Cuando el receptor de televisión no se utilice durante un periodo de tiempo prolongado, es aconsejable desconectar el cable de alimentación de la toma de CA.

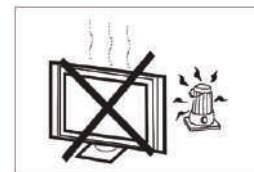

Evite exponer el receptor del televisor a la luz directa del sol ni a otras fuentes de calor. No coloque el receptor de televisión directamente sobre otros productos que desprendan calor, por ejemplo, reproductores de cintas de vídeo y amplificadores de audio. No coloque fuentes de llama desnuda, como velas encendidas, sobre el televisor.

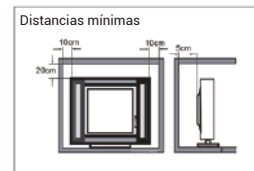

Si el televisor va a instalarse en un compartimento o recinto similar, deberán mantenerse las distancias mínimas. La acumulación de calor puede reducir la vida útil de su televisor y también puede ser peligrosa. Nota: el uso del aparato en climas moderados.

Precaución:

El televisor podría caer, provocando lesiones graves o la muerte. Muchas lesiones, especialmente en niños, pueden evitarse tomando unas sencillas precauciones tales como:

- Use SIEMPRE muebles, estantes o métodos de montaje recomendados por el fabricante del televisor.
- Utilice SIEMPRE muebles que puedan soportar el televisor de manera segura.
- Asegúrese SIEMPRE de que el televisor no sobresalga por el borde del mueble que lo sostiene.
- Informe SIEMPRE a los niños acerca del peligro de trepar por los muebles para llegar al televisor o a sus controles.
- Organice SIEMPRE los cables conectados al televisor de modo que no se pueda tropezar con ellos, tirar de ellos o agarrarlos.
- No coloque NUNCA un televisor en un lugar inestable.
- No coloque NUNCA el televisor sobre un mueble alto (por ejemplo armarios o estanterías) sin fijar tanto el mueble como el televisor a un soporte apto.
- No coloque NUNCA el televisor sobre un tejido u otros materiales que puedan encontrarse entre el televisor y el mueble que lo soporta.
- NUNCA coloque cosas que puedan tentar a los niños a trepar, como juguetes y mandos a distancia, encima del televisor o del mueble en el que esté colocado el televisor.

Si va a conservar y reubicar el televisor existente, se tendrán en consideración las mismas consideraciones anteriores.

PREPARACIÓN

IMPORTANTE: No ejerza presión sobre la zona de visualización de la pantalla, ya que podría comprometer su integridad. La garantía del fabricante no cubre el abuso por parte del usuario ni las instalaciones inadecuadas.

FIJAR EL SOPORTE

IMPORTANTE: El soporte del televisor debe montarse antes de utilizarlo.

1. Coloque el televisor boca abajo sobre una superficie blanda y plana (manta, espuma, paño, etc.) para evitar que se dañe.
2. Fije el soporte a la parte inferior del televisor con los 6 tornillos.

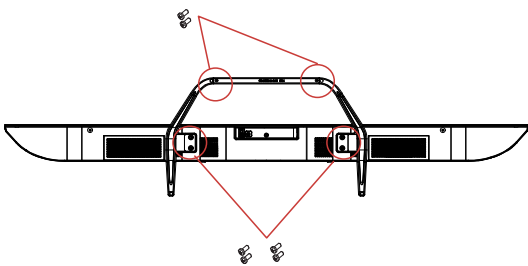

! NOTA

La apariencia del producto deberá ser en especie.

PREPARACIÓN DEL TELEVISOR LED PARA EL MONTAJE EN PARED

Le sugerimos que mantenga el televisor a una distancia mínima de 60 mm (2,36 pulgadas) de la pared para evitar interferencias con los cables. Antes de montar su televisor en la pared, debe retirar el soporte. Por su seguridad, utilícelo solo con un soporte de pared homologado por UL con un peso mínimo del televisor sin soporte.

Para fijar un soporte de pared a su televisor:

1. Retire los tornillos que sujetan el televisor al soporte.
2. Quitar el pedestal del TV.
3. Fije el soporte de pared a la parte posterior de su televisor con cuatro tornillos. Siga las instrucciones del manual del usuario que acompaña al soporte mural para instalarlo.

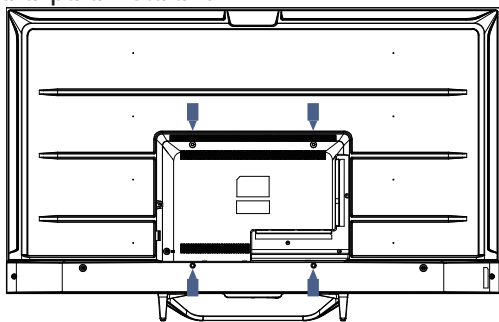

! NOTA

Los soportes de pared no están incluidos.

4. Fije los tornillos de montaje mural (M6x12mm/4pcs) en la parte trasera del televisor LED, con un par de apriete de 12kgf,cm.

ENCENDER EL TV

1. Instale el soporte y coloque el televisor sobre una superficie sólida.

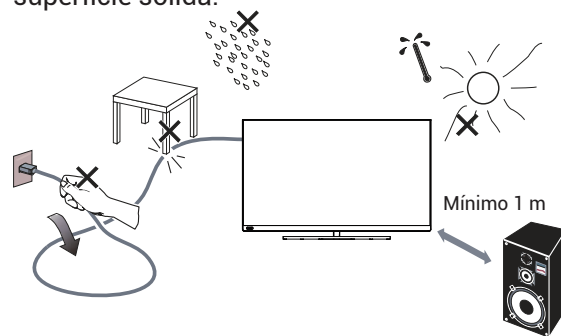

! NOTA

- Asegúrese de colocar el televisor en una posición que permita la libre circulación del aire. No cubra las aberturas de ventilación de la cubierta trasera.
 - Para evitar situaciones no seguras, no debería colocar sobre el aparato llamas desprotegidas, como velas encendidas.
 - Evite el calor, la luz solar directa y la exposición a la lluvia o al agua. El equipo no deberá estar expuesto a goteos ni salpicaduras.
2. Conecte el cable de antena o de televisión por cable a la toma de antena **ANT IN** de la parte posterior del televisor.
 3. Mando a distancia:
Retire la tapa del compartimento de las pilas. Inserte 2 pilas (tipo AAA 1,5 V).

PRECAUCIÓN: Existe riesgo de incendio y explosión si las pilas se reemplazan por otras de un tipo incorrecto.

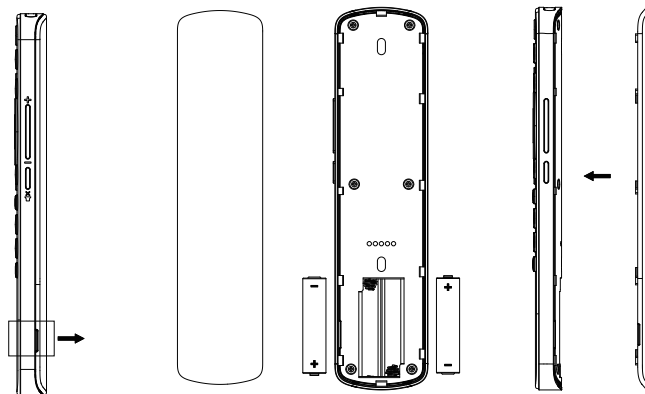

4. Alimentación:
Enchufe el cable a una toma de corriente que funcione.

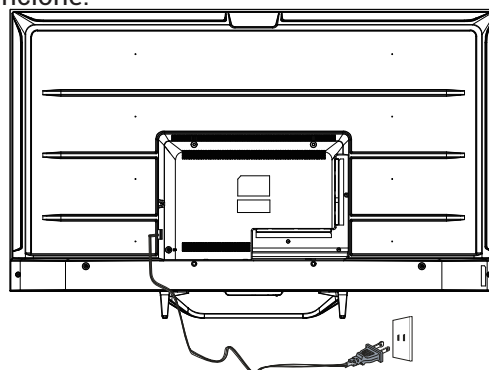

5. Encender o apagar el televisor:
Pulse en el mando a distancia o el botón **POWER** (Encendido) en el panel de control lateral del televisor.

CONEXIÓN PERIFÉRICA Y CONTROLES

CONTROL DE BOTONES

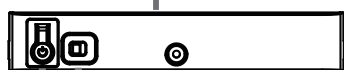
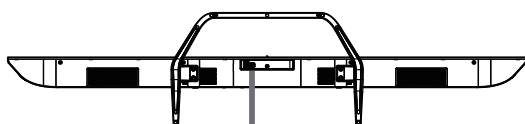
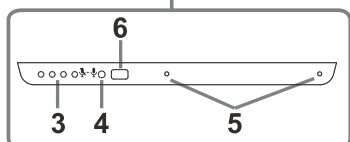
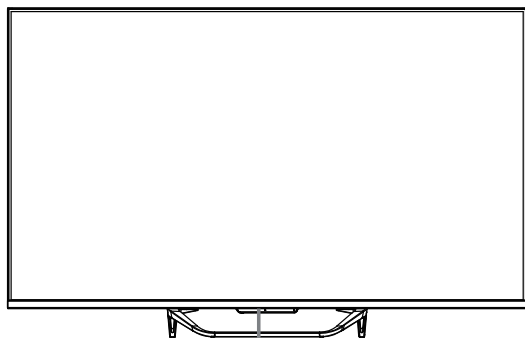

1 2

1. Encendido/Apagado
2. Voz activada/Voz desactivada
 - 🗣️ Habilitar al asistente de campo lejano
 - 🗣️ Desactivar el asistente de campo lejanoGírelo a la derecha para ponerlo en encendido, el indicador luminoso se encenderá y luego se apagará, la función de voz se ha iniciado. puede decir "Ok Google" para utilizar la función de voz, y el indicador se encenderá cuando el televisor reciba la voz, entonces diga directamente su petición. Gírelo a la izquierda para ponerlo en apagado y salir de la función de voz, la luz indicadora pasará a amarillo.
3. Luz de ayuda al campo lejano
4. Receptor de señal del mando a distancia
5. Receptor de señales de voz
6. Led de encendido

! NOTA
Asegúrese de que el televisor está conectado a Internet antes de utilizar Voz.
Póngalo en encendido antes de utilizar Voz.
Inicie sesión en su cuenta GOOGLE antes de utilizar Voz.

ACCESORIOS

- 1 mando a distancia
- 1 manual del usuario
- 6 tornillos
- 1 guía de inicio rápido
- 1 tarjeta de garantía

CONEXIÓN PERIFÉRICA



Todos los terminales son (de izquierda a derecha):
LAN, ÓPTICA, VÍDEO, IZQ, DER, HDMI4, HDMI3, HDMI2,



Todos los terminales son (de izquierda a derecha):
HDMI1 (eARC/ARC), ENTRADA LNB (SATÉLITE), ENTRADA ANT (ANTENA/CABLE), USB1 , USB2, AURICULAR, CI.

ESTABLECER LAS CONEXIONES

EQUIPOS AV

Este televisor proporciona un grupo de AV para una cómoda conexión a VCR, DVD u otros equipos de vídeo. Consulte también el manual de instrucciones del equipo que vaya a conectar. Puede utilizar los terminales de entrada de la parte trasera del televisor como se indica a continuación.

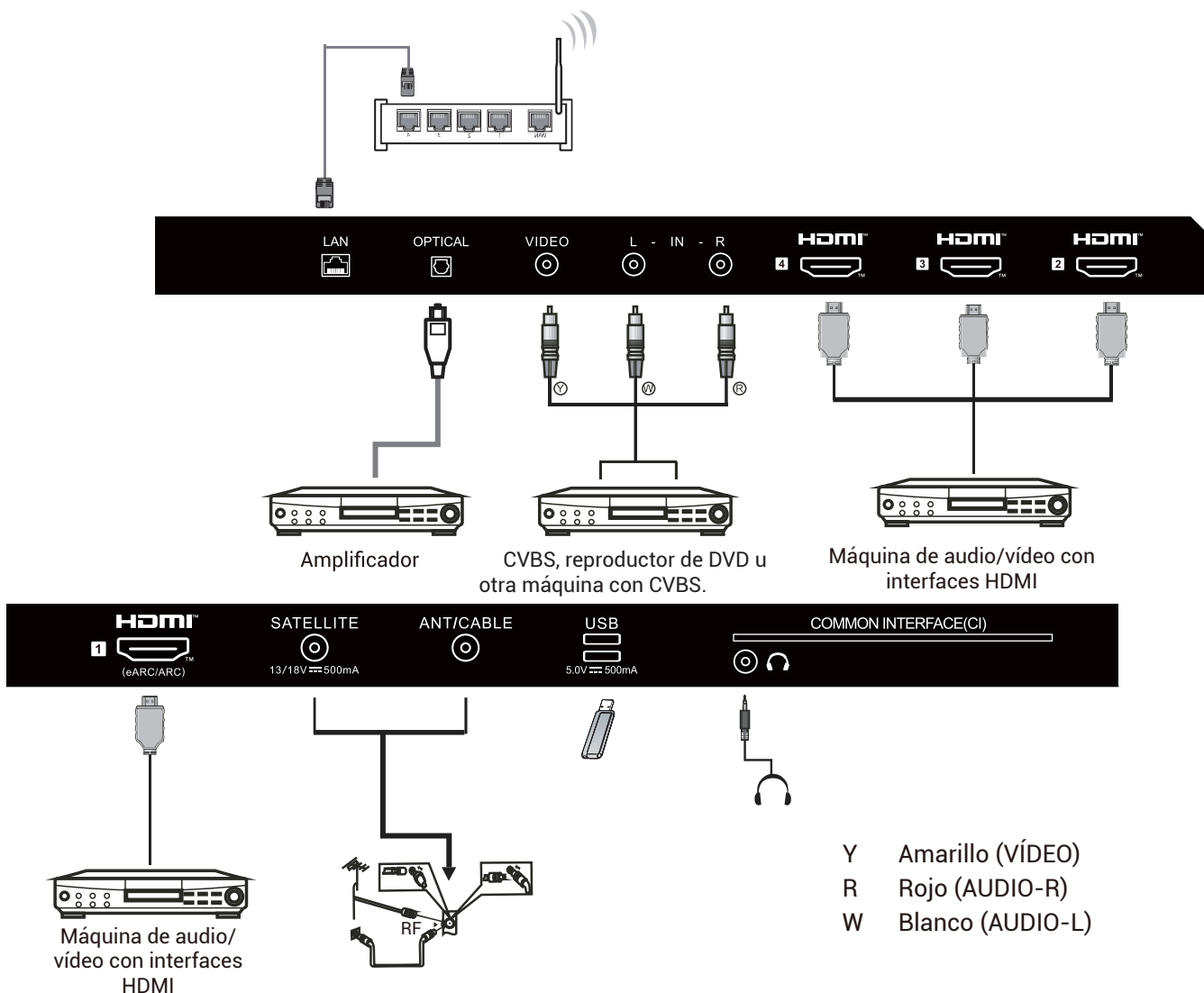

Puede conectarse a los siguientes aparatos: Grabadora, reproductor multidisco, DVD, videocámara, videojuegos o sistema estéreo, etc....

Nota:

A veces no será compatible en diferentes dispositivos porque el dispositivo suministra una señal no estándar.

INSTRUCCIONES DE USO

USAR EL MANDO A DISTANCIA

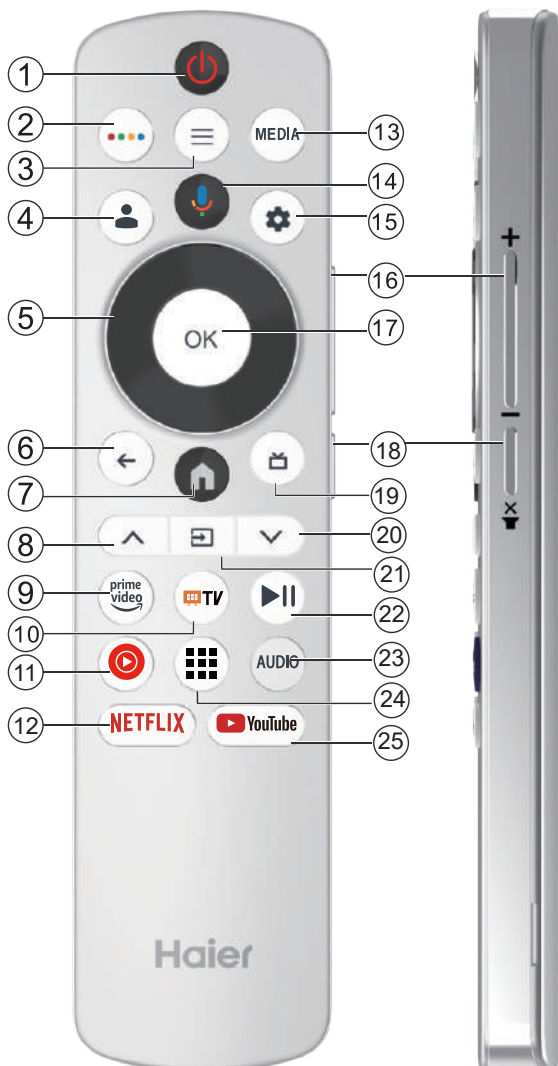

#	Elemento	Descripción
1	 Encendido	Pulse para encender o apagar el televisor. Cuando el televisor está apagado, la corriente sigue fluyendo a través de él. Para desconectar completamente la alimentación, desenchufe el cable de alimentación
2		Pulse para abrir el TABLERO MÁGICO.
3		Pulse para abrir o cerrar el menú en pantalla.
4		Pulse para ir a Accounts & Sign-in (Cuentas e Iniciar sesión) en Google TV (cuando se configura la TV básica, esta tecla no tiene ningún efecto).
5		Pulse para desplazarse por el menú en pantalla.
6		Volver al menú anterior.
7		Pulse para abrir la página de inicio.
8		Pulse para cambiar de canal.
9		Pulse para activar Prime Video para ver programas de televisión y películas en línea (requiere conexión a Internet).
10		Pulse para abrir la TV en directo.
11		Pulse para abrir YouTube Music.
12		Pulse para abrir NETFLIX.
13	MEDIA	Pulse para abrir el reproductor multimedia.
14		Pulse para abrir el Asistente de Google o iniciar la búsqueda por voz.
15		Pulse para abrir el menú de ajustes.
16	VOL+ VOL-	Pulse VOL+ o VOL- para ajustar el nivel de volumen.
17	OK	Introduce la opción seleccionada o realiza la operación seleccionada.
18		Para desactivar o activar el sonido.
19		Pulse para visualizar la guía electrónica de programas en el modo TV.
20		Pulse para cambiar de canal.
21		Pulse para abrir la lista de fuentes de entrada.
22		Púlselo para reproducir/pausar en modo multimedia.
23	AUDIO	Púlselo para cambiar de pista de audio.
24		Pulse para abrir las aplicaciones.
25		Pulse para abrir YouTube.

INSTRUCCIONES DE USO

CONFIGURACIÓN INICIAL

La primera vez que encienda el televisor, el asistente de configuración le guiará para configurar los ajustes básicos.

Siga las sugerencias de texto para configurar por primera vez.

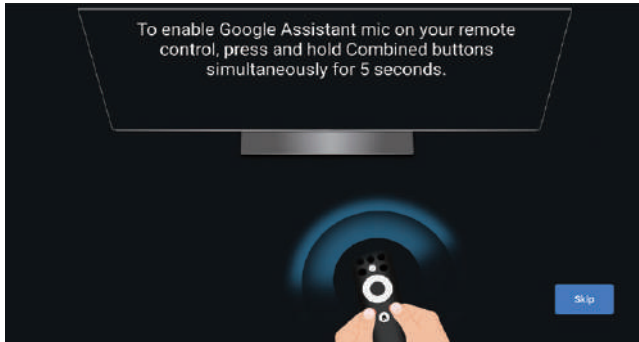

Esta función se utiliza para el código de par del mando a distancia. Cuando el código se haya introducido correctamente, podrá utilizar el mando a distancia Bluetooth para manejar el televisor.

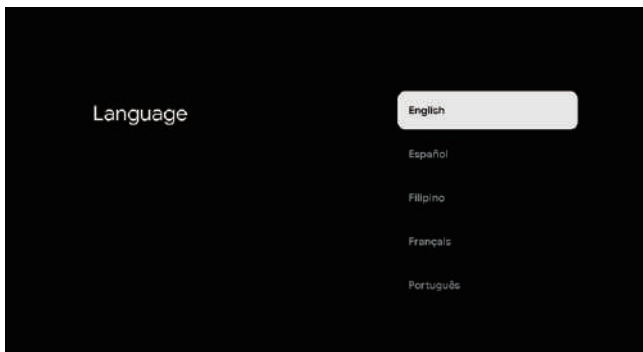

Pulse ▲/▼ para seleccionar el idioma del sistema y pulse **OK** para confirmar el idioma.

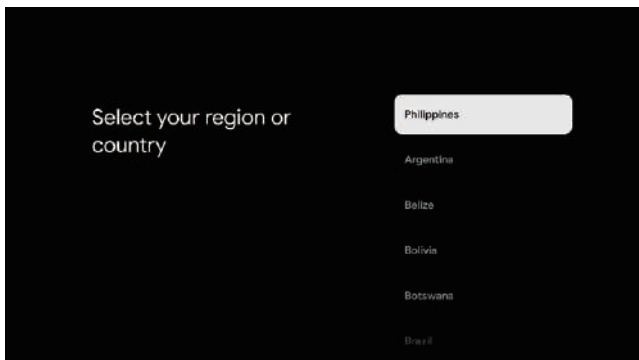

Pulse ▲/▼ para seleccionar el país/región del dispositivo y pulse **OK** para confirmar.

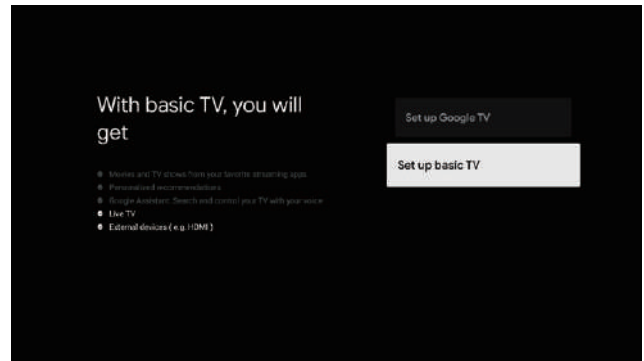

Pulse ▲/▼ para seleccionar "Configurar el TV básico" de su aparato y pulse **OK** para completar la configuración.

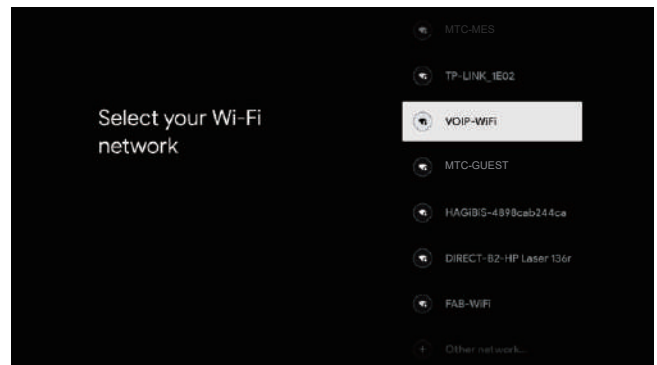

Pulse ▲/▼ para seleccionar el wifi al que se quiere conectar, pulse **OK** e introduzca la contraseña para confirmar que la conexión se ha realizado correctamente.

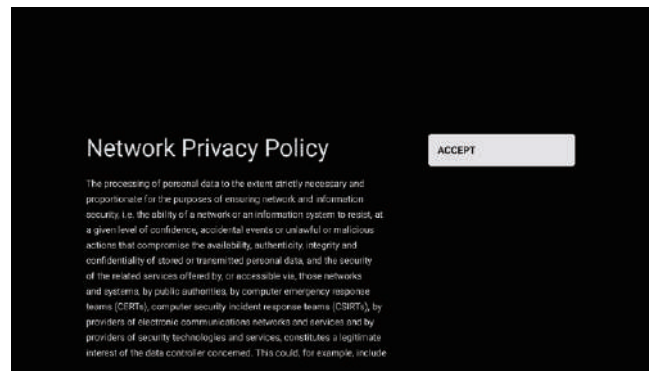

Seleccione "Accept" (Aceptar) para aceptar los términos de la Política de privacidad de la red.

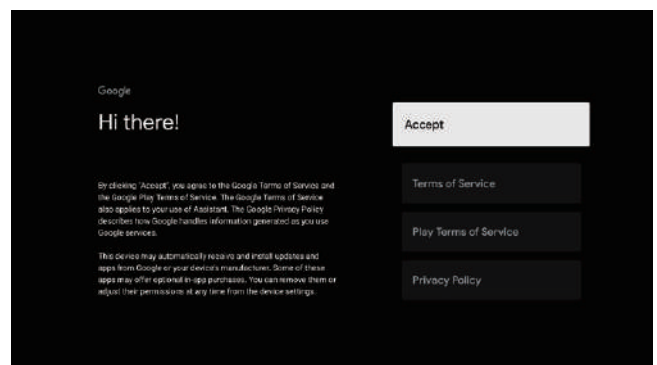

Al aceptar las Condiciones del servicio de Google para mejorar la experiencia del producto, seleccione "Accept" (Aceptar) para aceptar esta condición.

INSTRUCCIONES DE USO

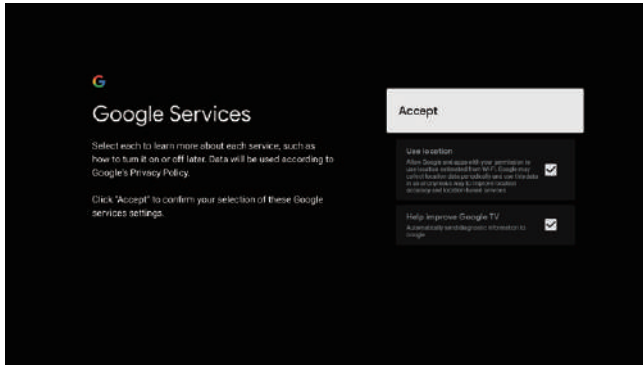

Al aceptar los Servicios de Google para mejorar la experiencia del producto, seleccione "Accept" (Aceptar) para aceptar esta condición.

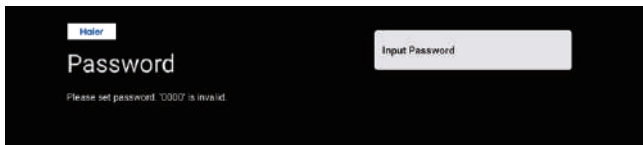

Permite establecer la contraseña de su dispositivo para garantizar la seguridad y la privacidad.

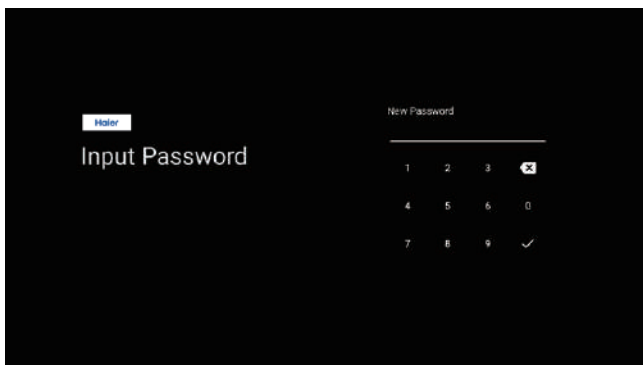

Utilice el mando a distancia/teclado blando para introducir la contraseña de 4 dígitos y saltar automáticamente a la siguiente interfaz.

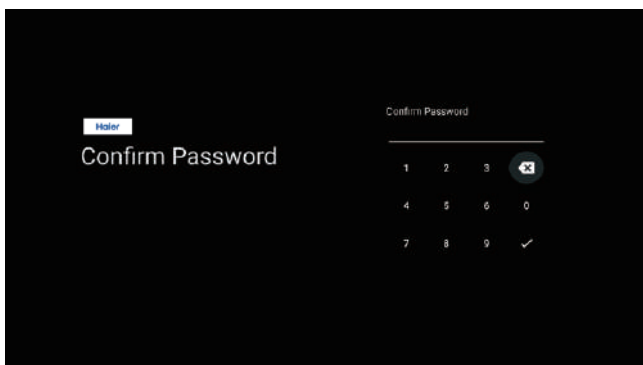

Confirme de nuevo la contraseña y manténgala constante Utilice el mando a distancia /teclado blando para introducir la contraseña y completarla.



Para seleccionar el modo, pulse la tecla ▲/▼ para seleccionar el modo Casa y pulse OK.

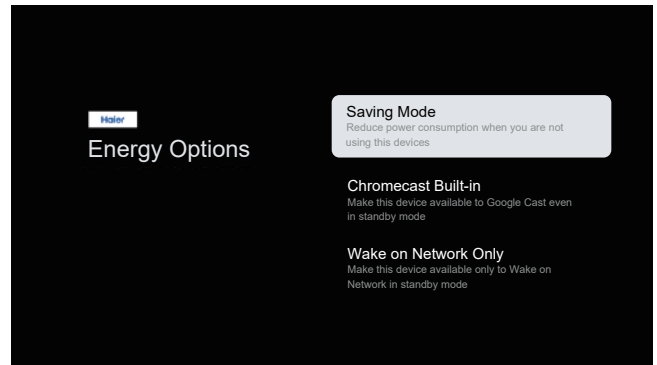

Seleccione "Saving Mode" (Modo ahorro) y continúe con el siguiente paso.

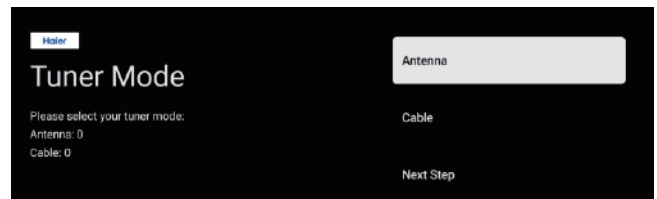

Seleccione el modo de sintonizador para la búsqueda, pulse para seleccionar y pulse OK para confirmar.

INSTRUCCIONES DE USO

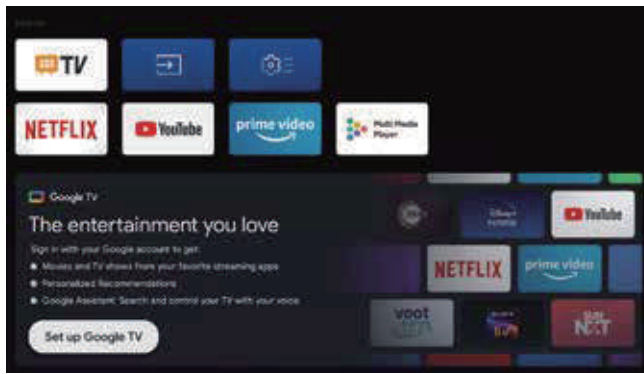

- Una vez en la interfaz de usuario, puede pasar de la televisión básica a la configuración de Google TV.

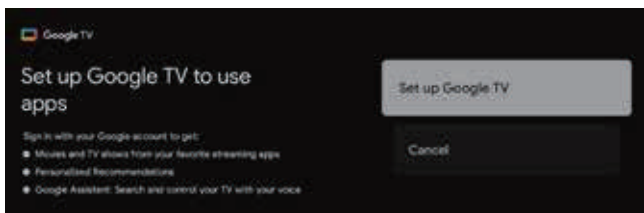

Pulse ▲/▼ para seleccionar "Set up Google TV" (Configurar Google TV) de su dispositivo y pulse OK para completar la configuración.

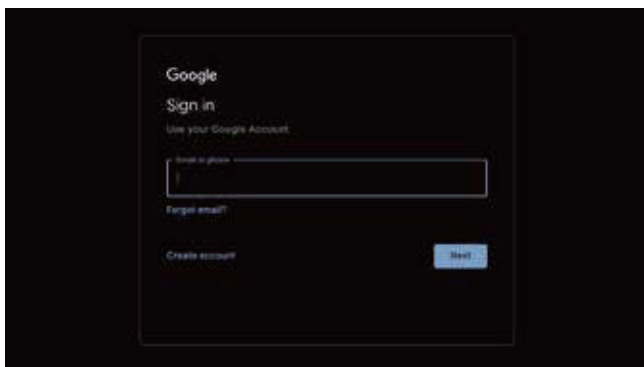

Utilice su cuenta de Google Iniciar sesión

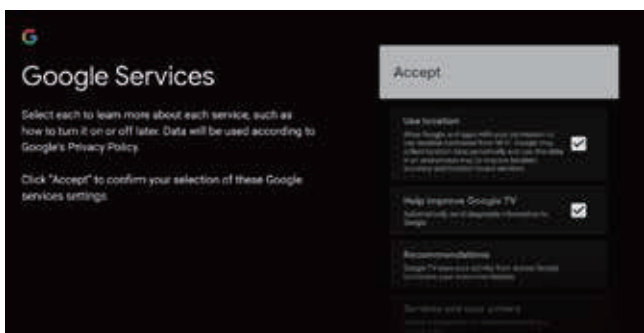
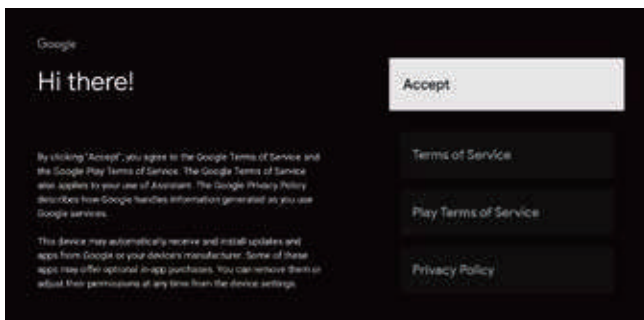

Al aceptar las Condiciones del servicio de Google para mejorar la experiencia del producto, seleccione "Accept" (Aceptar) para aceptar esta condición.

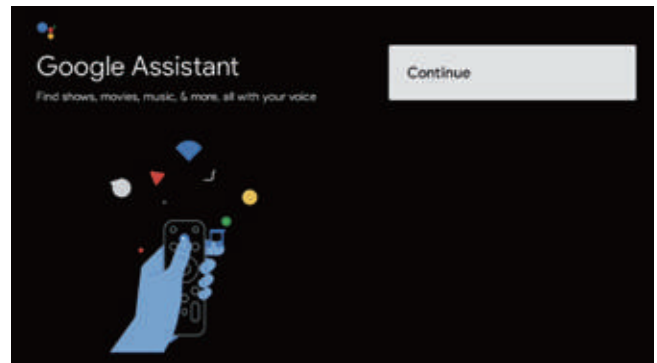

Pulse para seleccionar y pulse OK para continuar.

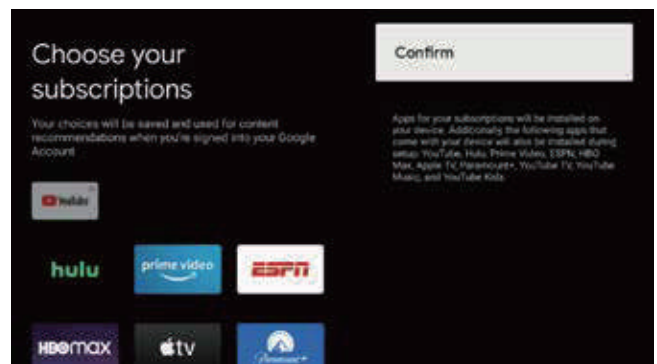

Pulse ▲/▼ para seleccionar Choose your subscriptions (Elegir suscripciones) y pulse OK.

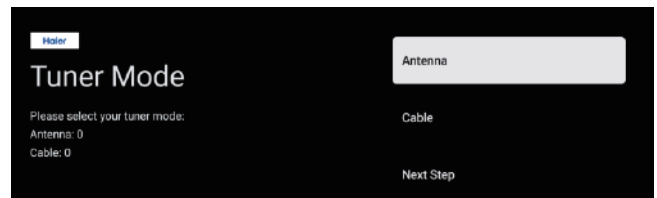

INSTRUCCIONES DE USO

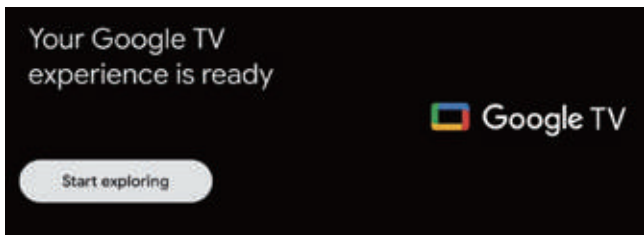

Su experiencia Google TV está lista y pulse OK para comenzar a explorar.

PANTALLA DE INICIO

Una vez completado el asistente de configuración, podrá ver la televisión e ir a la pantalla de inicio.

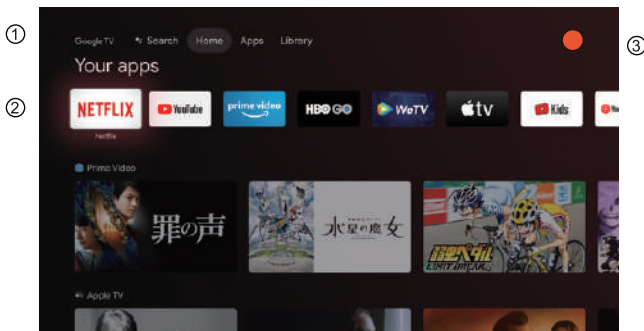

- ① **Search** Abra el asistente de google o inicie una búsqueda por voz.
Home Abra la página de inicio de su televisor.
Apps Abra la lista de aplicaciones que ha instalado y añada sus aplicaciones favoritas.
Library Ver los contenidos adquiridos y alquilados bajo la cuenta de usuario.
- ② Una lista de las aplicaciones que ha instalado y de los programas de contenido push que ha instalado.
- ③ Abra la información de su cuenta, los ajustes, la hora, las entradas y la imagen.
Settings (Ajustes): Aquí pueden configurarse varios ajustes. Para más detalles sobre los ajustes, consulte la siguiente explicación.
Inputs (Entradas): Icono para seleccionar la fuente de entrada.
Picture (Imagen): El usuario puede ajustar la imagen del televisor. Consulte la página 12 para obtener instrucciones detalladas sobre la configuración.

DESPLAZARSE POR EL MENÚ EN PANTALLA

Hay dos formas de acceder. Primero, en la TV en directo, pulse el botón de menú para mostrar las opciones de TV, pulse ▲/▼/◀/▶ para seleccionar el menú de ajustes y pulse OK para confirmar. En segundo lugar, en la interfaz INICIO, pulse la tecla ▶ para seleccionar el icono del menú ⚙️, pulse OK para confirmar.

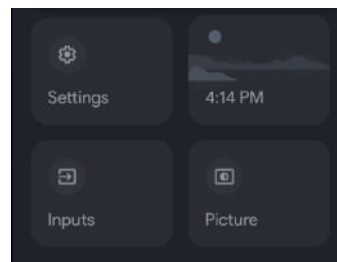
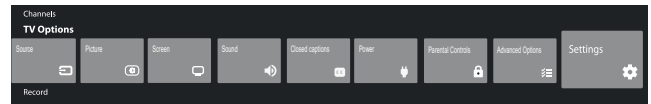

Pulse el botón ▲/▼ para seleccionar lo que desea ajustar. Pulse OK para acceder al ajuste.

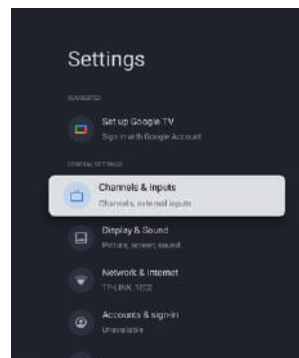

Pulse VOLVER para volver al menú anterior. Si aparece el menú principal, al pulsar VOLVER se cerrará el menú en pantalla.

INSTRUCCIONES DE USO

CANALES

Menu->Settings->Channels & Inputs->Channels (Menú->Configuración->Canales y entradas->Canales).

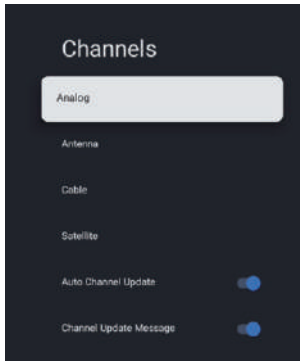

Analog/Antenna/Cable/Satellite (Análogo/Antena/Cable/Satélite): pulse el botón ▲/▼ para seleccionar la opción y, a continuación, pulse el botón OK para entrar en el submenú.

Auto Channel Update (Actualización automática de canal): pulse el botón OK para seleccionar **ON/OFF (Encendido/Apagado)**. Al seleccionar ON (Encendido), el sistema escaneará y actualizará automáticamente los canales después de 5 minutos en espera.

Channel Update Message (Mensaje de actualización de canal): pulse el botón OK para seleccionar **ON/OFF (Encendido/Apagado)**. Al seleccionar ON (Encendido), el sistema le mostrará el mensaje de actualización.

Nota: Las fuentes disponibles podrían variar según el modelo.

INPUTS (ENTRADAS)

Menu->Settings->Channels & Inputs->Inputs (Menú->Configuración->Canales y entradas->Entradas)

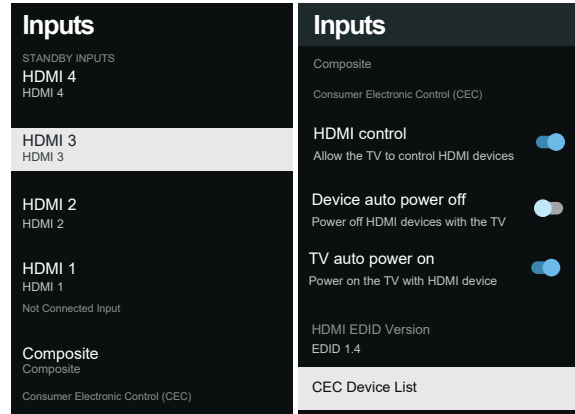

Inputs (Entradas): Pulse el botón ▲/▼ para seleccionar la opción y pulse OK para acceder al submenú.

HDMI Control (Control HDMI): Pulse el botón ▲/▼ para seleccionar la opción y, a continuación, pulse el botón OK para elegir Encendido/Apagado.

Device auto power off (Apagado automático del aparato): Pulse el botón ▲/▼ para seleccionar la opción y, a continuación, pulse el botón OK para elegir Encendido/Apagado.

TV auto power on (Encendido automático del televisor): Pulse el botón ▲/▼ para seleccionar la opción y, a continuación, pulse el botón OK para elegir Encendido/Apagado.

HDMI EDID Version (Versión HDMI EDID): Muestra la versión EDID.

CEC Device List (Lista de dispositivos CEC): Pulse el botón ▲/▼ para seleccionar la opción y, a continuación, pulse el botón OK para entrar en el submenú.

DISPLAY & SOUND (PANTALLA Y SONIDO)

Menu->Settings-> Display & Sound (Menú->Configuración-> Pantalla y sonido)

En este menú puede ajustar la imagen, el sonido y la salida de audio del televisor.

1. Pulse el botón ▲/▼ para seleccionar lo que desea ajustar.
2. Pulse el botón OK para
3. Una vez finalizado el ajuste, pulse el botón **VOLVER** para volver al menú anterior.

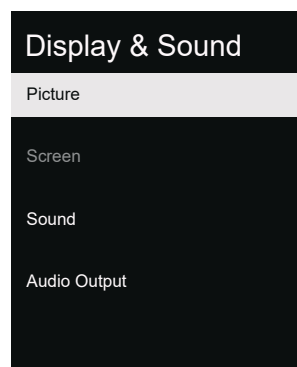

INSTRUCCIONES DE USO

IMAGEN

Menu->Settings->Display & Sound-> Picture (Menú-> Ajustes-> Pantalla y sonido-> Imagen).

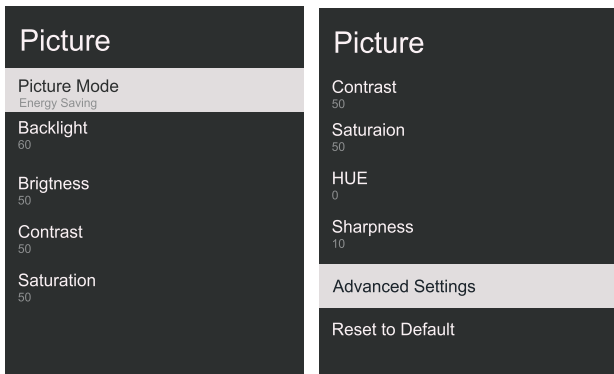

Picture Mode (Modo de imagen): Pulse el botón ▲/▼ para seleccionar la opción y, a continuación, pulse el botón OK para entrar en el submenú. (opcional: User (Usuario), Standard (Estándar), Vivid (Vívido), Sport (Deporte), Movie (Película), Game (Juego), Energy Saving (Ahorro de energía)).

Backlight/Brightness/Contrast/Saturation/HUE/Sharpness (Luz de fondo/Brillo/Contraste/Saturación/Tono/Nitidez): Pulse el botón ▲/▼ para seleccionar la opción y, a continuación, pulse el botón OK para entrar.

Pulse ◀ para disminuir el parámetro. Pulse ▶ para acceder al parámetro.

Advanced Settings (Configuración avanzada): Pulse el botón ▲/▼ para seleccionar la opción y, a continuación, pulse el botón OK para entrar en el submenú.

Reset to Default (Restablecer valores predeterminados): Restablece todos los ajustes a los valores predeterminados de fábrica.

SONIDO

Menu->Settings-> Display & Sound->Sound (Menú-> Configuración-> Pantalla y sonido-> Sonido).

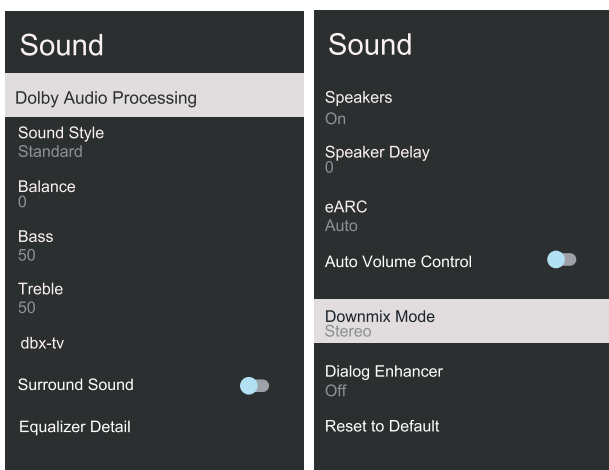

Dolby Audio processing (Procesamiento de audio Dolby): Pulse el botón ▲/▼ para seleccionar la opción y, a continuación, pulse el botón OK para entrar en el submenú.

Sound style (Estilo de sonido): Pulse el botón ▲/▼ para seleccionar la opción y, a continuación, pulse el botón OK para entrar en el submenú (opcional: User (Usuario), Standard (Estándar), Night (Noche), Sports (Deportes), Movie (Película), Music (Música), News (Noticias)).

Balance/ Bass/ Treble (Balance/Graves/Agudos): Pulse el botón ▲/▼ para seleccionar la opción y luego pulse el botón OK para entrar.

Pulse ◀ para disminuir el parámetro.

Pulse ▶ para acceder al parámetro.

Dbx- TV: Pulse el botón ▲/▼ para seleccionar la opción y, a continuación, pulse el botón OK para entrar en el submenú.

Surround Sound (Sonido envolvente): Pulse el botón ▲/▼ para seleccionar la opción y, a continuación, pulse el botón OK para elegir Encendido/Apagado.

Equalizer Detail (Detalle de ecualizador): Pulse el botón ▲/▼ para seleccionar la opción y luego pulse el botón OK para entrar en el submenú.

Speakers (Altavoces) Pulse el botón ▲/▼ para seleccionar la opción y luego pulse el botón OK para elegir Encendido/Apagado.

Speaker Delay (Retardo del altavoz): Pulse el botón ▲/▼ para seleccionar la opción y, a continuación, pulse el botón OK para entrar.

Pulse ◀ para disminuir el parámetro. Pulse ▶ para acceder al parámetro.

eARC: Pulse el botón ▲/▼ para seleccionar la opción y, a continuación, pulse el botón OK para elegir Auto/OFF.

Auto Volume Control (Control automático del volumen): Pulse el botón ▲/▼ para seleccionar la opción y, a continuación, pulse el botón OK para elegir Encendido/Apagado.

Downmix Mode (Modo Downmix): Pulse el botón ▲/▼ para seleccionar la opción y luego pulse el botón OK para entrar en el submenú (opcional: Stereo (Estéreo), Surround (Envolvente)).

Dialog Enhancer (Mejorador de diálogo): Pulse el botón ▲/▼ para seleccionar la opción y, a continuación, pulse el botón OK para entrar en el submenú.

(opcional: Apagado, Bajo, Medio y Alto).

Reset to Default (Restablecer valores predeterminados): Restablece todos los ajustes a los valores predeterminados de fábrica.

INSTRUCCIONES DE USO

AUDIO OUTPUT (SALIDA DE AUDIO)

Menu->Settings->Display & Sound-> Audio Output (Menú-> Configuración-> Pantalla y sonido-> Salida de audio).

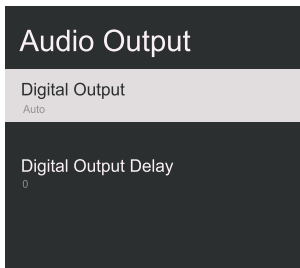

Digital Output (Salida digital): Pulse el botón ▲/▼ para seleccionar la opción y, a continuación, pulse el botón OK para entrar en el submenú. (opcional: Auto, Bypass, PCM, Dolby Digital Plus y Dolby Audio-Dolby Digital).

Digital Output Delay (Retardo de salida digital): Pulse el botón ▲/▼ para seleccionar la opción y luego pulse el botón OK para entrar. Pulse ◀ para disminuir el parámetro. Pulse ▶ para acceder al parámetro.

NETWORK (RED)

Menu->Settings->Network & Internet (Menú-> Configuración-> Red e Internet)

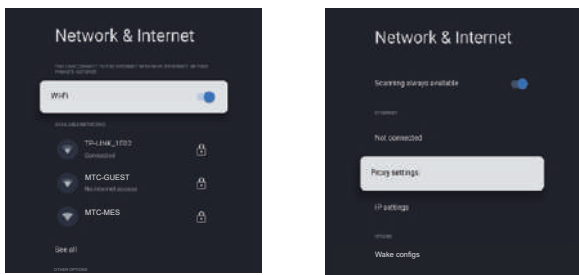

1. Pulse el botón ▲/▼ para seleccionar lo que desea ajustar.
2. Pulse el botón OK para confirmar.
3. Una vez finalizado el ajuste, pulse el botón OK para guardar y volver al menú anterior.

ACCOUNTS & SIGN IN (CUENTAS E INICIO DE SESIÓN)

1. Menu->Settings->Accounts & sign-in (Menú-> Configuración-> Cuentas e inicio de sesión).
2. En la interfaz HOME (INICIO), pulse el botón ▲/▼ para seleccionar "Set up Google TV" (Configurar Google TV) y continúe con el siguiente paso.

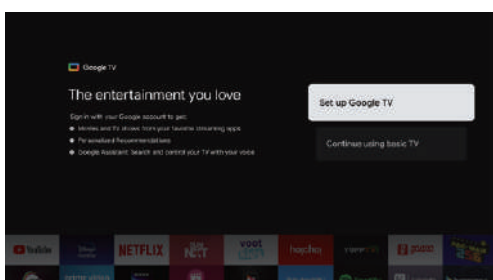

Seleccione "Set up Google TV" (Configurar Google TV) y continúe con el siguiente paso, introduzca su cuenta y contraseña. Y siga las indicaciones para completar los ajustes pertinentes.

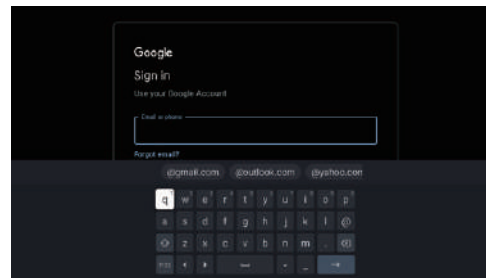

PRIVACIDAD

Menu->Settings->Privacy (Menú-> Configuración-> Privacidad).

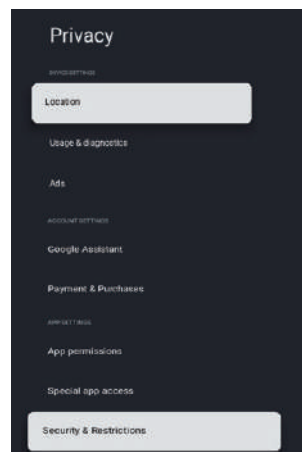

En este menú, puede configurar la ubicación, el uso y el diagnóstico, etc. del televisor.

1. Pulse el botón ▲/▼ para seleccionar lo que desea ajustar.
2. Pulse el botón OK para confirmar.
3. Una vez finalizado el ajuste, pulse el botón VOLVER para volver al menú anterior.

LOCATION (UBICACIÓN)

Menu->Settings->Privacy ->Location (Menú-> Configuración-> Privacidad-> Localización).

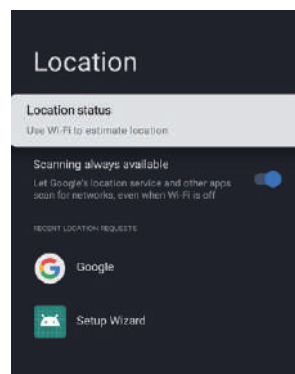

INSTRUCCIONES DE USO

Location status (Estado de la ubicación): Pulse el botón ▲/▼ para seleccionar la opción y, a continuación, pulse el botón OK para entrar en el submenú.

(opcional: Use Wi-Fi to estimate location (Utilizar Wi-Fi para estimar la ubicación), Off (Desactivado))

Scanning always available (Escaneado siempre disponible): Pulse el botón ▲/▼ para seleccionar la opción y, a continuación, pulse el botón OK para elegir Encendido/Apagado.

USAGE & DIAGNOSTICS (USO Y DIAGNÓSTICO)

Menu->Settings->Privacy ->Usage & diagnostics (Menú-> Configuración-> Privacidad-> Uso y diagnóstico)

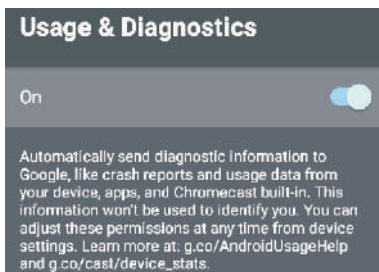

Usage & diagnostics (Uso y diagnóstico): Pulse el botón ▲/▼ para seleccionar la opción y, a continuación, pulse el botón OK para elegir Encendido/Apagado.

APPS (APLICACIONES)

Menu->Settings->Apps (Menú-> Configuración-> Aplicaciones).

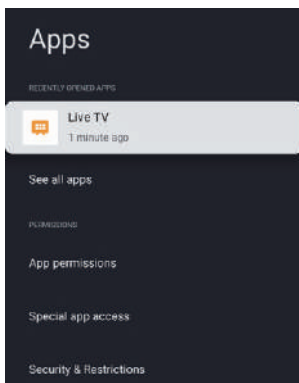

En este menú, puede establecer los permisos de la aplicación, y leer las listas de aplicaciones

1. Pulse el botón ▲/▼ para seleccionar lo que desea ajustar.
2. Pulse el botón OK para confirmar.
3. Una vez finalizado el ajuste, pulse el botón VOLVER para volver al menú anterior.

SISTEMA

Menu->Settings->System (Menú-> Configuración-> Sistema).

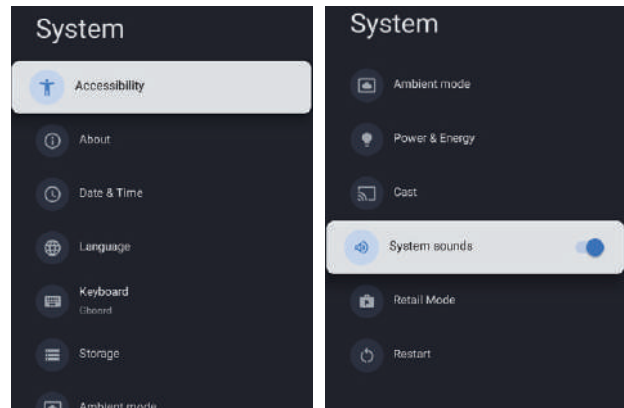

En este menú, puede leer la información y los ajustes del televisor.

1. Pulse el botón ▲/▼ para seleccionar lo que desea ajustar.
2. Pulse el botón OK para confirmar.
3. Una vez finalizado el ajuste, pulse el botón VOLVER para volver al menú anterior.

System sounds (Sonidos del sistema): Pulse el botón ▲/▼ para seleccionar la opción y, a continuación, pulse el botón OK para elegir Encendido/Apagado. Para más detalles sobre el sistema, consulte la siguiente explicación.

ACCESSIBILITY (ACCESIBILIDAD)

Menu->Settings->System -> Accessibility (Menú-> Configuración-> Sistema -> Accesibilidad).

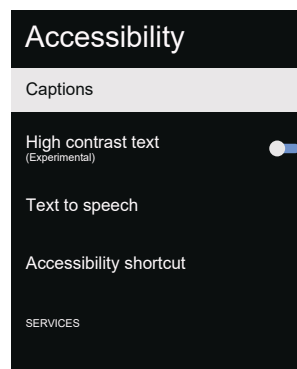

Captions (Subtítulos): Pulse el botón ▲/▼ para seleccionar la opción y luego pulse el botón OK para entrar en el submenú.

High contrast text (Texto de alto contraste): Pulse el botón ▲/▼ para seleccionar la opción y, a continuación, pulse el botón OK para elegir Encendido/Apagado.

Text to speech (Texto a voz): Pulse el botón ▲/▼ para seleccionar la opción y, a continuación, pulse el botón OK para entrar en el submenú.

Accessibility shortcut (Acceso directo a la accesibilidad): Pulse el botón ▲/▼ para seleccionar la opción y, a continuación, pulse el botón OK para entrar en el submenú.

INSTRUCCIONES DE USO

ABOUT (INFORMACIÓN)

Menu->Settings->System ->About (Menú-> Configuración-> Sistema-> Información).

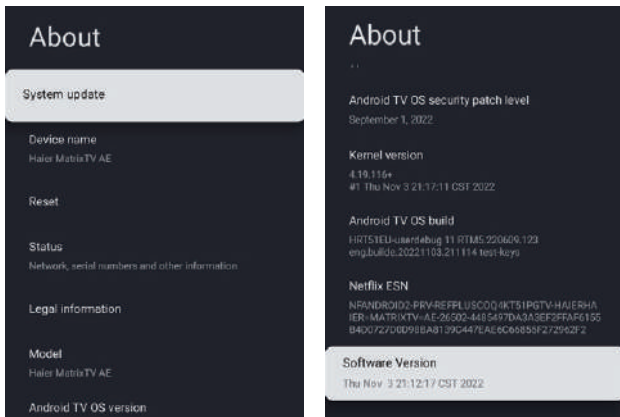

En este menú, puede System update (Actualizar el sistema), Reset (Reiniciar) y leer la información del televisor.

1. Pulse el botón ▲/▼ para seleccionar lo que desea ajustar.
2. Pulse el botón OK para confirmar.
3. Una vez finalizado el ajuste, pulse el botón VOLVER para volver al menú anterior.

DATE&TIME (FECHA Y HORA)

Menu->Settings->System -> Date & Time (Menú-> Configuración-> Sistema-> Fecha y hora).

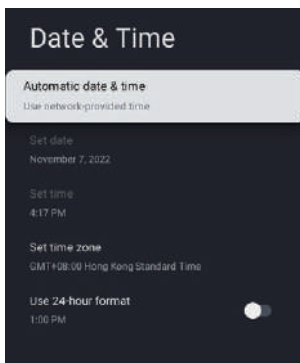

Automatic date & time (Fecha y hora automáticas): Pulse el botón ▲/▼ para seleccionar la opción y, a continuación, pulse el botón OK para entrar en el submenú.

(opcional: Use network-provided time, Off (Utilizar el tiempo proporcionado por la red, Apagado))

NOTA

- Si la fecha y la hora automáticas están en OFF (Apagado), puede configurar la fecha y la hora manualmente.

Set date (Ajustar fecha): Pulse el botón ▲/▼ para seleccionar la opción y, a continuación, pulse el botón OK para entrar en el submenú.

Set time (Ajustar la hora): Pulse el botón ▲/▼ para seleccionar la opción y, a continuación, pulse el botón OK para entrar en el submenú.

Set time zone (Ajustar zona horaria): Pulse el botón ▲/▼ para seleccionar la opción y luego pulse el botón OK para entrar en el submenú.

Use 24-hour format (Utilizar el formato de 24 horas): Pulse el botón ▲/▼ para seleccionar la opción y, a continuación, pulse el botón OK para elegir Encendido/Apagado.

LANGUAGE (IDIOMA)

Menu->Settings->System-> Language (Menú-> Configuración-> Sistema-> Idioma).

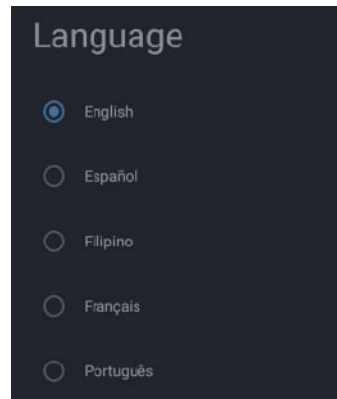

Idioma: Pulse el botón ▲/▼ para seleccionar la opción y, a continuación, pulse el botón OK para entrar en el idioma seleccionado.

KEYBOARD (TECLADO)

Menu->Settings->System-> Keyboard (Menú-> Configuración-> Sistema-> Teclado).

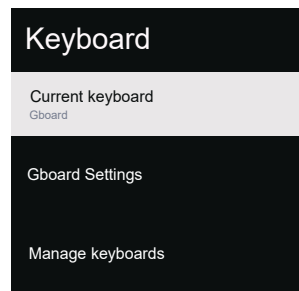

Current keyboard (Teclado actual): Pulse el botón ▲/▼ para seleccionar la opción y, a continuación, pulse el botón OK para entrar en el submenú.

Gboard Settings (Configuración Gboard): Pulse el botón ▲/▼ para seleccionar la opción y, a continuación, pulse el botón OK para entrar en el submenú.

Manage keyboards (Gestionar teclados): Pulse el botón ▲/▼ para seleccionar la opción y, a continuación, pulse el botón OK para entrar en el submenú.

STORAGE (ALMACENAMIENTO)

Menu->Settings-> System->Storage (Menú-> Configuración-> Sistema-> Almacenamiento).

INSTRUCCIONES DE USO

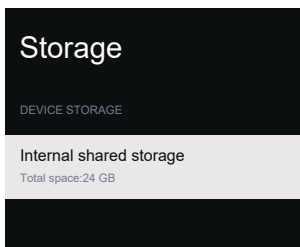

Internal shared storage (Almacenamiento interno compartido): Pulse el botón ▲/▼ para seleccionar la opción y, a continuación, pulse el botón OK para entrar en el submenú.

AMBIENT MODE (MODO AMBIENTE)

Menu->Settings->System-> Ambient mode (Menú-> Configuración-> Sistema-> Modo ambiente).

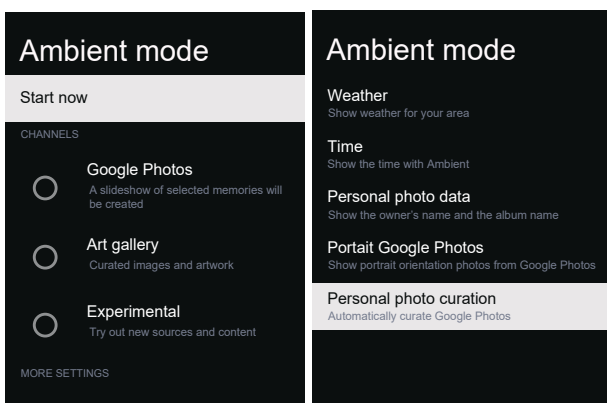

En este menú puede ajustar el modo ambiente.

1. Pulse el botón ▲/▼ para seleccionar lo que desea ajustar .
2. Pulse el botón OK para confirmar.
3. Una vez finalizado el ajuste, pulse el botón VOLVER para volver al menú anterior.

POWER & ENERGY (POTENCIA Y ENERGÍA)

Menu->Settings-> System->Power & Energy (Menú-> Configuración-> Sistema-> Potencia y Energía).

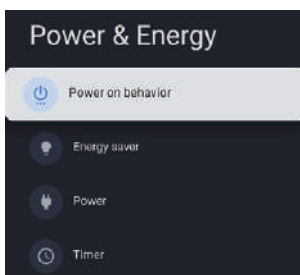

En este menú, puede ajustar la potencia y la energía (comportamiento de encendido, ahorro de energía, encendido y temporizador)

1. Pulse el botón ▲/▼ para seleccionar lo que desea ajustar.
2. Pulse el botón OK para confirmar.
3. Una vez finalizado el ajuste, pulse el botón VOLVER para volver al menú anterior.

POWER ON BEHAVIOR (COMPORTEMIENTO DE ENCENDIDO)

Menu->Settings->System->Power & Energy->Power on behavior (Menú-> Configuración-> Sistema-> Potencia y energía-> Comportamiento de encendido).

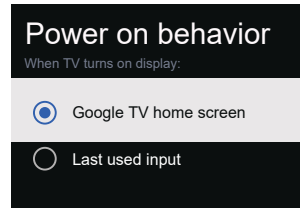

Pulse el botón ▲/▼ para seleccionar la opción y, a continuación, pulse el botón OK para confirmar.

ENERGY SAVER (AHORRO DE ENERGÍA)

Menu->Settings->System-> Power & Energy ->Energy saver (Menú-> Configuración-> Sistema-> Potencia y energía-> Ahorro de energía).

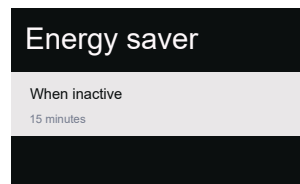

When inactive (Cuando está inactivo): Pulse el botón ▲/▼ para seleccionar la opción y, a continuación, pulse el botón OK para entrar en el submenú. (opcional: 15 minutos, 20 minutos, 30 minutos, 1 hora, 4 horas, 8 horas, 12 horas, 24 horas, Nunca).

ENCENDIDO

Menu->Settings->System-> Power & Energy->Power (Menú-> Configuración-> Sistema-> Potencia y energía-> Energía).

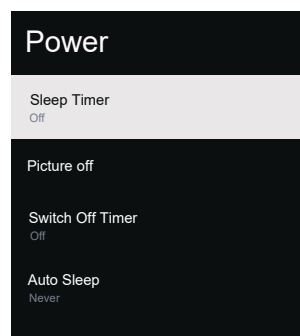

Sleep Timer (Temporizador de reposo): Pulse el botón ▲/▼ para seleccionar la opción y, a continuación, pulse el botón OK para entrar en el submenú (opcional: Off (Apagado), 10 minutes (10 minutos), 20 minutes (20 minutos), 30 minutes (30 minutos), 40 minutes (40 minutos), 50 minutes (50 minutos), 60 minutes (60 minutos), 90 minutes (90 minutos), 120 minutes (120 minutos)).

INSTRUCCIONES DE USO

Picture Off (Imagen desactivada): Pulse el botón ▲/▼ para seleccionar la opción y, a continuación, pulse el botón **OK** para confirmar.

Switch off timer (Temporizador de apagado): Pulse el botón ▲/▼ para seleccionar la opción y, a continuación, pulse el botón **OK** para entrar en el submenú

(opcional: Off (Apagado), 30 minutes (30 minutos), 60 minutes (60 minutos), 90 minutes (90 minutos), 120 minutes (120 minutos), 150 minutes (150 minutos), 180 minutes (180 minutos), 210 minutes (210 minutos), 240 minutes (240 minutos)).

Reposo automático: Pulse el botón ▲/▼ para seleccionar la opción y, a continuación, pulse el botón **OK** para entrar en el submenú.
(opcional: Never (Nunca), 4 hours (4 horas), 6 hours (6 horas), 8 hours (8 horas))

TIMER (TEMPORIZADOR)

Menu->Settings-> System-> Power & Energy->Timer (Menú-> Configuración-> Sistema-> Potencia y energía-> Temporizador).

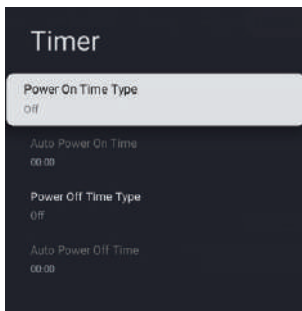

Power On Time Type (Tipo de tiempo de encendido): Pulse el botón ▲/▼ para seleccionar la opción y luego pulse el botón **OK** para elegir OFF/ON/ONCE (Desactivado/Activado/Una vez).

Auto Power On Time (Hora de encendido automático): Pulse el botón ▲/▼ para seleccionar la opción y, a continuación, pulse el botón **OK** para entrar en el submenú.

Power Off Time Type (Tipo de tiempo de apagado): Pulse el botón ▲/▼ para seleccionar la opción y luego pulse el botón **OK** para elegir OFF/ON/ONCE (Desactivado/Activado/Una vez).

Auto Power Off Time (Hora de apagado automático): Pulse el botón ▲/▼ para seleccionar la opción y, a continuación, pulse el botón **OK** para entrar en el submenú.

CAST (TRANSMISIÓN)

Menu->Settings->System-> Cast (Menú-> Configuración-> Sistema-> Reparto).

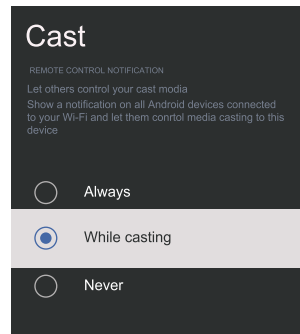

1. Pulse el botón ▲/▼ para seleccionar lo que desea ajustar.
2. Pulse el botón **OK** para confirmar.
3. Pulse el botón **VOLVER** para volver al menú anterior.

RETAIL MODE (MODO TIENDA)

Menu->Settings->System-> Retail Mode (Menú-> Configuración-> Sistema-> Modo tienda).

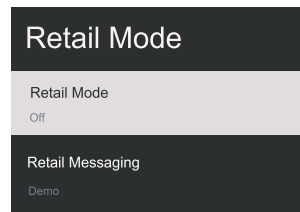

Retail Mode (Modo tienda): Pulse el botón ▲/▼ para seleccionar la opción y, a continuación, pulse el botón **OK** para elegir Encendido/Apagado.

Retail messaging (Mensajería de tienda): Pulse el botón ▲/▼ para seleccionar la opción y, a continuación, pulse el botón **OK** para entrar en el submenú. (Nota: Demo, e-POP, e-POP + Demo)

RESTART (REINICIO)

Menu->Settings->System-> Restart (Menú-> Configuración-> Sistema-> Reinicio).

Pulse el botón **OK** para acceder al submenú (opcional: Restart (Reiniciar) y Cancel (Cancelar)).

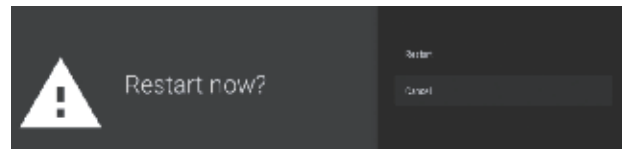

INSTRUCCIONES DE USO

REMOTES & ACCESSORIES (MANDOS A DISTANCIA Y ACCESORIOS)

Menu->Settings-> Remotes & Accessories (Menú-> Configuración-> Mandos a distancia y accesorios).

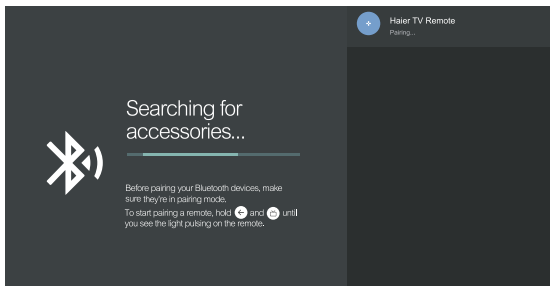
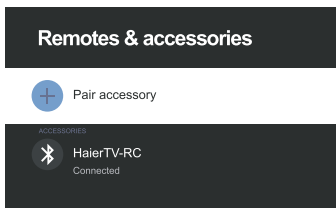

En este menú, puede emparejar dispositivos Bluetooth.

1. Pulse durante 5 segundos los botones ← y → situados en la parte inferior del mando a distancia.
2. Cuando el LED empiece a parpadear, suéltelo. El mando a distancia enviará la señal de emparejamiento al televisor y mostrará la información del mando a distancia en la parte derecha de la pantalla.
3. Pulse el botón **OK** para ver el emparejamiento. Si aparece el emparejamiento, la conexión se ha realizado correctamente.
4. Si aparece el mensaje no se pudo emparejar, la conexión ha fallado. Espere 30 segundos y pulse los botones ← y → situados en la parte inferior del mando a distancia durante 5 segundos para repetir los pasos anteriores.
5. Pulse el botón ← para volver al menú anterior.

USE OF MULTI MEDIA PLAYER (USO DEL REPRODUCTOR MULTIMEDIA)

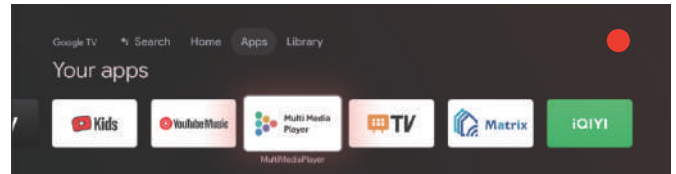

1. En la interfaz de HOME (INICIO) o APPS (APLICACIONES), pulse ▲/▼/◀/▶ para seleccionar la aplicación Reproductor multimedia

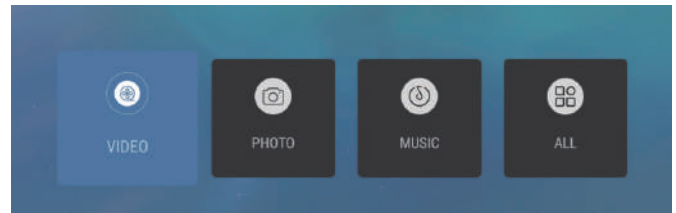

2. Seleccione la tecla OK para entrar en el reproductor multimedia y visualizar vídeo, foto, audio. Tras insertar la unidad flash usb, podrá ver los archivos correspondientes en la unidad flash usb (formato FAT32).

NOTA

El menú puede ser diferente según la fecha de compra del televisor.

RESOLUCIÓN DE PROBLEMAS

Realice estas sencillas comprobaciones antes de llamar al servicio técnico. Estos consejos pueden ahorrarle tiempo y dinero, ya que los gastos de instalación del receptor y los ajustes de los controles del cliente no están cubiertos por la garantía.

Síntomas	Elementos a comprobar y acciones a seguir
"Fantasma" o doble imagen	<ul style="list-style-type: none"> Puede estar causada por obstrucciones en la recepción de la antena provocadas por edificios altos o colinas cercanas. Utilizando una antena direccional de alto nivel puede mejorar la imagen.
Sin alimentación	<ul style="list-style-type: none"> Compruebe si el cable de alimentación de CA del televisor está enchufado a la toma de corriente. Desenchufe el televisor y espere 60 segundos. A continuación, vuelva a insertar el enchufe en la toma de corriente y encienda de nuevo el televisor.
No hay imagen	<ul style="list-style-type: none"> Compruebe las conexiones de la antena en la parte trasera del televisor para ver si está correctamente conectada al televisor. Posibles problemas en la estación de radiodifusión. Pruebe otro canal. Ajuste el contraste y el brillo. Compruebe el control de subtítulos. Algunos modos de TEXTO podrían bloquear la pantalla.
Buena imagen pero sin sonido	<ul style="list-style-type: none"> Pulse el botón SILENCIAR mando a distancia para cambiar desactivado.
Buen sonido pero mal color	<ul style="list-style-type: none"> Ajuste los valores de contraste, color y brillo.
Mala imagen	<ul style="list-style-type: none"> Puede producirse una mala calidad de imagen cuando se conecta una cámara o videocámara S-VHS activada al televisor y a otros periféricos al mismo tiempo. Desconecte uno de los periféricos.
Imagen con nieve y ruido	<ul style="list-style-type: none"> Compruebe la conexión de la antena.
Línea de puntos horizontal	<ul style="list-style-type: none"> Esto puede deberse a interferencias eléctricas (por ejemplo, secador de pelo, luces de neón cercanas, etc.) Apague el equipo.
El televisor no responde al mando a distancia	<ul style="list-style-type: none"> Compruebe si las pilas funcionan. Sustitúyalo si es necesario. Limpie la lente del sensor del mando a distancia del televisor.
Píxeles (puntos) siempre oscuros o siempre iluminados	<ul style="list-style-type: none"> Su televisor está fabricado con precisión utilizando un nivel tecnológico extremadamente alto. Sin embargo, a veces puede que los píxeles no se muestren correctamente. Este tipo de incidencias son inherentes a este tipo de productos y no constituyen un producto defectuoso.

NOTA

- Este producto utiliza un panel formado por subpíxeles cuya producción requiere una tecnología sofisticada. Sin embargo, puede haber algunos píxeles brillantes u oscuros en la pantalla. Estos píxeles no tendrán ningún impacto en el rendimiento del producto.



Los términos HDMI, HDMI High-Definition Multimedia Interface, HDMI Trade Dress y los logotipos de HDMI son marcas comerciales o marcas comerciales registradas de HDMI Licensing Administrator, Inc



Dolby, Dolby Vision, Dolby Atmos, Dolby Audio y el símbolo de la doble D son marcas comerciales de Dolby Laboratories Licensing Corporation. Fabricado bajo licencia de Dolby Laboratories. Trabajos inéditos confidenciales. Derechos de autor ©2012-2024 Dolby Laboratories. Todos los derechos reservados.

ESPECIFICACIONES DEL PRODUCTO

TV LED UHD de 43"

Calidad de imagen de televisión:	UHD Digital integrado. Tamaño de la pantalla: 108 cm Resolución 3840 x 2160 píxeles 60 Hz.
Sistema del TV:	PAL-B/G, SECAM-B/G
Descodificador sintonizador DTV	DVB-T, DVB-C, DVB-T2, DVB-S2 Modulación QAM 16/32/64/128/256 MPEG2, MPEG4, H.265
Conectividad:	1 puerto óptico 2 puertos USB 1 LAN 4 tomas HDMI 1 toma de VÍDEO 1 toma IZQ 1 toma DER 2 tomas RF 1 puerto para auriculares 1 ranura CI Sistemas compatibles: PAL+SECAM Número de canal de almacenamiento: 1000 (DTV), 100 (ATV) TV (RF): desequilibrio de 75 Ω Entrada de vídeo AV: 75 Ω, 1 V-P, RCA Salida de audio AV: 20K Ω, 500 mV RMS Salida de vídeo HDMI: 480i, 480p, 720p, 1080i, 1080p, 2160p Wi-Fi: Estándar: IEEE 802.11a/b/g/n/ac, frecuencia: 2,4 GHz/5 GHz Bluetooth: V5.1
Calidad de sonido:	Sistema de sonido estéreo. 2 x 10 vatios RMS de potencia de salida.
Consumo de energía en modo de espera	≤ 0,5 W
Características digitales:	Digitalmente interactivo. Texto digital. Subtítulos disponibles para la radiodifusión de vídeo digital (DVB). Configuración automática. Búsqueda automática de nuevos canales. Guía de programas actual y siguiente. Guía electrónica de programas (EPG) de 7 días. Ranura CI. Compatible con audiodescripción.
Características adicionales:	Sintonizador UHF/VHF; temporizador de apagado automático; guía paterna; imagen y texto Se necesitan 2 pilas AAA para el mando a distancia. Tamaño de montaje VESA: 300 x 300 mm Tamaño del paquete (An x Al x Pr): 1075 x 652 x 142 mm Tamaño del juego (An x Al x Pr) con soporte: 957,2 x 607,4 x 240,7 mm Tamaño del conjunto (An x Al x Pr) sin soporte: 957,2 x 566,7 x 86,6 mm Peso del paquete: 10 kg Ajuste el peso con el soporte: 7,2kg Ajuste el peso sin soporte: 6,8 kg

* Las especificaciones de las piezas de este televisor que se facilitan aquí son solo de referencia. Pueden producirse diferencias a medida que se actualiza la tecnología del producto. El diseño y las especificaciones están sujetos a cambios sin previo aviso.

ESPECIFICACIONES DEL PRODUCTO

TV LED UHD de 50"

Calidad de imagen de televisión:	UHD Digital integrado. Tamaño de la pantalla: 126cm Resolución 3840 x 2160 píxeles 60 Hz.
Sistema del TV:	PAL-B/G, SECAM-B/G
Descodificador sintonizador DTV	DVB-T, DVB-C, DVB-T2, DVB-S2 Modulación QAM 16/32/64/128/256 MPEG2, MPEG4, H.265
Conectividad:	1 puerto óptico 2 puertos USB 1 LAN 4 tomas HDMI 1 toma de VÍDEO 1 toma IZQ 1 toma DER 2 tomas RF 1 puerto para auriculares 1 ranura CI Sistemas compatibles: PAL+SECAM Número de canal de almacenamiento: 1000 (DTV), 100 (ATV) TV (RF): Desequilibrio 75 Ω Entrada de vídeo AV: 75 Ω, 1 V-P, RCA Salida de audio AV: 20K Ω, 500 mV RMS Entrada de vídeo HDMI: 480i, 480p, 720p, 1080i, 1080p, 2160p Wi-Fi: Estándar: IEEE 802.11a/b/g/n/ac, frecuencia: 2,4 GHz/5 GHz Bluetooth: V5.1
Calidad de sonido:	Sistema de sonido estéreo. 2 x 13.5 vatios RMS de potencia de salida.
Consumo de energía en modo de espera	≤ 0,5 W
Características digitales:	Digitalmente interactivo. Texto digital. Subtítulos disponibles para la radiodifusión de vídeo digital (DVB). Configuración automática. Búsqueda automática de nuevos canales. Guía de programas actual y siguiente. Guía electrónica de programas (EPG) de 7 días. Ranura CI. Compatible con audiodescripción.
Características adicionales:	Sintonizador UHF/VHF; temporizador de apagado automático; guía paterna; imagen y texto Se necesitan 2 pilas AAA para el mando a distancia. Tamaño de montaje VESA: 300 x 300 mm Tamaño del paquete (An x Al x Pr): 1250 x 760 x 144 mm Tamaño del juego (An x Al x Pr) con soporte: 1111,2 x 710,5 x 277,2 mm Tamaño del conjunto (An x Al x Pr) sin soporte: 1111,2 x 651,8 x 88 mm Peso del paquete: 13,5kg Ajuste el peso con el soporte: 10 kg Ajuste el peso sin soporte: 9,5kg

* Las especificaciones de las piezas de este televisor que se facilitan aquí son solo de referencia. Pueden producirse diferencias a medida que se actualiza la tecnología del producto. El diseño y las especificaciones están sujetos a cambios sin previo aviso.

ESPECIFICACIONES DEL PRODUCTO

TV LED UHD de 55"

Calidad de imagen de televisión:	UHD Digital integrado. Tamaño de la pantalla: 139 cm Resolución 3840 x 2160 píxeles 60 Hz.
Sistema del TV:	PAL-B/G, SECAM-B/G
Descodificador sintonizador DTV	DVB-T, DVB-C, DVB-T2, DVB-S2 Modulación QAM 16/32/64/128/256 MPEG2, MPEG4, H.265
Conectividad:	1 puerto óptico 2 puertos USB 1 LAN 4 tomas HDMI 1 toma de VÍDEO 1 toma IZQ 1 toma DER 2 tomas RF 1 puerto para auriculares 1 ranura CI Sistemas compatibles: PAL+SECAM Número de canal de almacenamiento: 1000 (DTV), 100 (ATV) TV (RF): desequilibrio de 75 Ω Entrada de vídeo AV: 75 Ω, 1 V-P, RCA Salida de audio AV: 20K Ω, 500 mV RMS Salida de vídeo HDMI: 480i, 480p, 720p, 1080i, 1080p, 2160p Wi-Fi: Estándar: IEEE 802.11a/b/g/n/ac, frecuencia: 2,4 GHz/5 GHz Bluetooth: V5.1
Calidad de sonido:	Sistema de sonido estéreo. 2 x 13,5 vatios RMS de potencia de salida.
Consumo de energía en modo de espera	≤ 0,5 W
Características digitales:	Digitalmente interactivo. Texto digital. Subtítulos disponibles para la radiodifusión de vídeo digital (DVB). Configuración automática. Búsqueda automática de nuevos canales. Guía de programas actual y siguiente. Guía electrónica de programas (EPG) de 7 días. Ranura CI. Compatible con audiodescripción.
Características adicionales:	Sintonizador UHF/VHF; temporizador de apagado automático; guía paterna; imagen y texto Se necesitan 2 pilas AAA para el mando a distancia. Tamaño de montaje VESA: 300 x 300 mm Tamaño del paquete (An x Al x Pr): 1350 x 837 x 144 mm Tamaño del juego (An x Al x Pr) con soporte: 1225,8 x 777,3 x 277,2 mm Tamaño del conjunto (An x Al x Pr) sin soporte: 1225,8 x 719,4 x 88,1 mm Peso del paquete: 16,4kg Ajuste el peso con el soporte: 11,9kg Ajuste el peso sin soporte: 11,4kg

* Las especificaciones de las piezas de este televisor que se facilitan aquí son solo de referencia. Pueden producirse diferencias a medida que se actualiza la tecnología del producto. El diseño y las especificaciones están sujetos a cambios sin previo aviso.

ESPECIFICACIONES DEL PRODUCTO

TV LED UHD de 65"

Calidad de imagen de televisión:	UHD Digital integrado. Tamaño de la pantalla: 164cm Resolución 3840 x 2160 píxeles 60 Hz.
Sistema del TV:	PAL-B/G, SECAM-B/G
Descodificador sintonizador DTV	DVB-T, DVB-C, DVB-T2, DVB-S2 Modulación QAM 16/32/64/128/256 MPEG2, MPEG4, H.265
Conectividad:	1 puerto óptico 2 puertos USB 1 LAN 4 tomas HDMI 1 toma de VÍDEO 1 toma IZQ 1 toma DER 2 tomas RF 1 puerto para auriculares 1 ranura CI Sistemas compatibles: PAL+SECAM Número de canal de almacenamiento: 1000 (DTV), 100 (ATV) TV (RF): Desequilibrio 75 Ω Entrada de vídeo AV: 75 Ω, 1 V-P, RCA Salida de audio AV: 20K Ω, 500 mV RMS Entrada de vídeo HDMI: 480i, 480p, 720p, 1080i, 1080p, 2160p Wi-Fi: Estándar: IEEE 802.11a/b/g/n/ac, frecuencia: 2,4 GHz/5 GHz Bluetooth: V5.1
Calidad de sonido:	Sistema de sonido estéreo. 2 x 13,5 vatios RMS de potencia de salida.
Consumo de energía en modo de espera	≤ 0,5 W
Características digitales:	Digitalmente interactivo. Texto digital. Subtítulos disponibles para la radiodifusión de vídeo digital (DVB). Configuración automática. Búsqueda automática de nuevos canales. Guía de programas actual y siguiente. Guía electrónica de programas (EPG) de 7 días. Ranura CI. Compatible con audiodescripción.
Características adicionales:	Sintonizador UHF/VHF; temporizador de apagado automático; guía paterna; imagen y texto Se necesitan 2 pilas AAA para el mando a distancia. Tamaño de montaje VESA: 400 x 300 mm Tamaño del paquete (An x Al x Pr): 1600 x 960 x 164 mm Tamaño del juego (An x Al x Pr) con soporte: 1446,4 x 904,7 x 313,8 mm Tamaño del conjunto (An x Al x Pr) sin soporte: 1446,4 x 841,3 x 85,1 mm Peso del paquete: 24 kg Ajuste el peso con el soporte: 17,2 kg Ajuste el peso sin soporte: 16,5 kg

* Las especificaciones de las piezas de este televisor que se facilitan aquí son solo de referencia. Pueden producirse diferencias a medida que se actualiza la tecnología del producto. El diseño y las especificaciones están sujetos a cambios sin previo aviso.

Haier

Haier

Inspiroitua elämää

Käyttöohje

MALLIT:

H43Q80FUX

H50Q80FUX

H55Q80FUX

H65Q80FUX



Tämän oppaan kuvat ovat vain viitteellisiä ja ne voivat poiketa todellisen laitteen ulkonäöstä. Tuotteen suunnittelua ja tietoja voidaan muuttaa ilman eri ilmoitusta.

LED-televisio

SISÄLLYSLUETTELO

1. TÄRKEITÄ TURVAOHJEITA	1
2. VALMISTELU	3
3. OHEISLAITTEIDEN LIITÄNTÄ JA SÄÄTIMET	4
4. LIITÄNTÖJEN TEKEMINEN	5
5. KÄYTTÖOHJEET	6
6. VIANMÄÄRITYS.....	18
7. TUOTTEEN TEKNISET TIEDOT	19





Tämän oppaan kuvat ovat vain viitteellisiä ja ne voivat poiketa todellisen laitteen ulkonäöstä. Tuotteen suunnittelua ja tietoja voidaan muuttaa ilman eri ilmoitusta.

TÄRKEITÄ TURVAOHJEITA

- 1) Lue nämä ohjeet.
- 2) Säilytä nämä ohjeet.
- 3) Ota huomioon kaikki varoitukset.
- 4) Noudata kaikkia ohjeita.
- 5) Älä käytä tätä laitetta veden lähellä.
- 6) Puhdista vain kuivalla liinalla.
- 7) Älä tuki ilmanvaihtoaukkoja, asenna ohjeiden mukaisesti.
- 8) Älä asenna lähelle lämmönlähteitä, kuten lämpöpattereita, lämpökaappeja, uuneja tai muita laitteita (mukaan lukien vahvistimet), jotka tuottavat lämpöä.
- 9) Älä mitätöi polaroidun pistokkeen turvaominaisuuksia. Jos laitteessa oleva pistoke ei sovi pistorasiaan, pyydä sähköasentajaa vaihtamaan vanhentunut pistorasia.
- 10) Suojaa virtajohtoa päällä kävelemiseltä tai puristumiselta, varsinkin pistokkeiden ja pistorasioiden läheisyydessä ja kohdassa, jossa se kytkeytyy laitteeseen.
- 11) Käytä ainoastaan valmistajan määrittämiä lisävarusteita/lisälaitteita.
- 12) Irrota laite sähköverkosta ukonilman aikana tai kun sitä ei käytetä pitkään aikaan.
- 13) Turvaudu kaikessa huollossa pätevään huoltohenkilöstöön. Laite on huollettava, mikäli se on rikkoutunut jollakin tavalla, kuten sen virtajohto tai pistoke on vioittunut, sen päälle on kaatunut nesteitä tai sen sisälle on pudonnut esineitä, laite on altistunut sateelle tai kosteudelle, se ei toimi normaalisti tai se on pudonnut.
- 14) Pistoketta käytetään virran katkaisuun laitteesta ja sen on oltava helposti käytettävissä.
- 15) Ilmanvaihtoa ei saa estää peittämällä aukkoja esineillä kuten sanomalehdillä, pöytäliinalla, verhoilla jne.
- 16) Laitteen päälle ei saa asettaa avotulen lähteitä, kuten palavia kynttilöitä.
- 17) Ympäristönsuojeluun liittyvät tekijät on huomioitava akkujen hävittämisessä.
- 18) Käytä laitetta maltillisissa lämpötiloissa.
- 19) Laitetta ei saa altistaa veden valumiselle tai roiskeille, eikä vedellä täytettyjä esineitä, kuten maljakoita, saa asettaa laitteen päälle.
- 20) Varoitus: Tuotteen kallistumisen aiheuttamien vammojen välttämiseksi varmista aina, että koko tuote on asetettu pöydän pinnalle vaakasuoraan.

* Todellinen tuote voi poiketa ulkonäöltään yllä olevasta kuvasta*

Jos virtajohdon pistoketta käytetään katkaisulaitteena, asennusohjeissa on mainittava, että pistokkeella kytkettävien laitteiden pistorasia on oltava helposti käytettävissä.

	HUOMIO SÄHKÖISKUN VAARA ÄLÄ AVAA!	
HUOMIO ÄLÄ AVAA KANTTA (TAI TAUSTAA) SÄHKÖISKUN VAARAN VÄLTÄMISEKSI. SISÄLLÄ EI OLE KÄYTTÄJÄN HUOLLETTAVIA OSIA. TURVAUDU KAIKESSA HUOLLOSSA PÄTEVÄÄN HUOLTOHENKILÖSTÖÖN.		



Symboli osoittaa, että laitteessa on vaarallisia jännitteitä, jotka aiheuttavat sähköiskun vaaran.



Symboli osoittaa, että tämän laitteen mukana on tärkeitä käyttö- ja huolto-ohjeita.

VAROITUS:

Tulipalovaaran ja sähköiskun vaaran välttämiseksi älä jätä laitetta alttiiksi sateelle tai kosteudelle.

VAROITUS:

Paristoja ei saa altistaa liialliselle kuumuudelle, kuten auringonpaisteelle, tulelle tai vastaavalle.



Tämä symboli osoittaa, että tuotteessa on kaksoiseristys vaarallisen jännitteen ja käyttäjän käytettävissä olevien osien välillä. Käytä huollon yhteydessä vain identtisiä varaosia.



Tämä merkki ilmaisee, että tätä tuotetta ei saa hävittää kotitalousjätteen seassa. Jätteiden hallitsemattomasta hävityksestä ympäristölle tai ihmisten terveydelle aiheutuvien vahinkojen estämiseksi kierrätä tuote vastuullisesti materiaaliresurssien kestävä uudelleenkäytön edistämiseksi. Kun haluat palauttaa käytetyn laitteen, käytä palautus- ja keräysjärjestelmää tai ota yhteyttä siihen jälleenmyyjään, jolta tuote ostettiin. He voivat toimittaa tämän tuotteen ympäristönsuojelumääräysten mukaiseen kierrätykseen.

TÄRKEITÄ TURVAOHJEITA

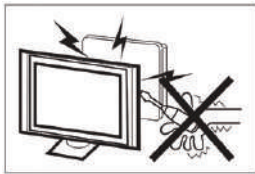

Tämän televisiovastaanottimen toimintaan liittyy korkeita jännitteitä. Älä irrota taustaosaa vastaanottimen rungosta. Turvaudu kaikessa huollossa pätevään huoltohenkilöstöön.

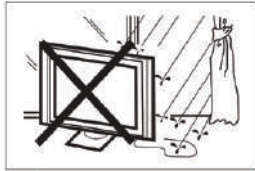

Välttääksesi tulipalon tai sähköiskun vaaran, älä altista laitetta sateelle tai kosteudelle.



Älä pudota tai työnnä esineitä televisiokaapin aukkoihin. Älä koskaan roiskuta minkäänlaista nestettä televisiovastaanottimen päälle.



Älä tuki takakannen tuuletusaukkoja. Riittävä ilmanvaihto on välttämätöntä sähkökomponenttien vikaantumisen estämiseksi.



Älä jätä virtajohtoa puristuksiin televisiovastaanottimen alle.



Jos aiot puhdistaa tuotteen, irrota televisio pistorasiasta, käytä pehmeää liinaa, ei vettä, ei koskaan kemikaaleja.



Älä koskaan seiso television tai sen jalustan päällä, nojaa siihen tai työnnä sitä äkillisesti. Kiinnitä erityistä huomiota lapsiin. Television kaatumisesta voi aiheutua vakavia vammoja.

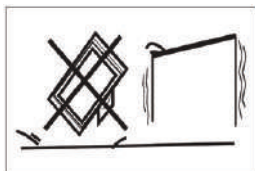

Älä aseta televisiota epävakaalle kärrylle, telineelle, hyllylle tai pöydälle. Television kaatumisesta voi aiheutua vakavia vammoja tai televisio voi vaurioitua.



Kun televisiovastaanotinta ei käytetä pitkään aikaan, on suositeltavaa irrottaa verkkovirtajohto pistorasiasta.

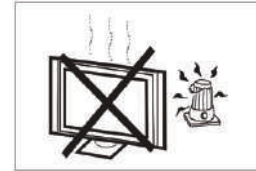

Vältä televisiovastaanottimen altistamista suoralle auringonvalolle tai muille lämmönlähteille. Älä aseta televisiovastaanotinta suoraan muiden lämpöä tuottavien tuotteiden, kuten videokasettisoittimien ja äänenvahvistimien, päälle. Älä aseta television päälle avotulen lähteitä, kuten palavia kynttilöitä.

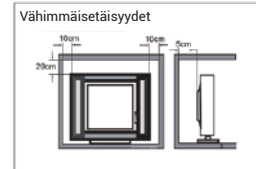

Jos televisio on tarkoitus asentaa kaappiin tai vastaavaan koteloon, vähimmäisetäisyyksiä on noudatettava. Lämmön muodostuminen voi lyhentää television käyttöikää ja se voi olla myös vaarallista. Huomaa: käytä laitetta maltillisissa lämpötiloissa.

Varoitus:

Televisio voi pudota ja aiheuttaa vakavan henkilövahingon tai kuoleman. Monet vahingot, etenkin lapsiin kohdistuvat, voidaan välttää noudattamalla yksinkertaisia varotoimenpiteitä, kuten:

- Käytä AINA televisiovastaanottimen valmistajan suosittelemia kaappeja, telineitä tai kiinnitysmenetelmiä.
- Käytä AINA huonekaluja, jotka tukevat televisiota turvallisesti.
- Varmista AINA, että televisio ei ulotu tukevan huonekalun reunan yli.
- Kerro AINA lapsille, että on vaarallista kiivetä huonekalujen päälle televisioon tai sen säätimiin ylettymiseksi.
- Reititä AINA televisioon liitetyt johdot ja kaapelit niin, että kukaan ei kompastu niihin, vedä niitä tai tartu niihin.
- Älä KOSKAAN aseta televisiovastaanotinta epävakaalle alustalle.
- Älä KOSKAAN aseta televisiovastaanotinta korkeiden huonekalujen (esimerkiksi kaappien tai kirjahyllyjen) päälle kiinnittämättä sekä huonekalua että televisiota sopivaan tukeen.
- Älä KOSKAAN aseta televisiovastaanotinta liinojen tai muiden materiaalien päälle, joita voi olla television ja tukihuonekalun välissä.
- Älä KOSKAAN aseta television päälle tai sen alla olevien kalusteiden päälle esineitä, kuten leluja ja kaukosäätimiä, jotka saattavat houkuttaa lasta kiipeämään.

Edellä mainitut asiat on huomioitava myös silloin, kun olemassa oleva televisiovastaanotin siirretään toiseen paikkaan.

VALMISTELU

TÄRKEÄÄ: Älä paina ruudun näyttöaluetta, se saattaa vaurioittaa näyttöä. Valmistajan antama takuu ei kata väärinkäyttöä tai virheellistä asennusta.

JALUSTAN KIINNITTÄMINEN

TÄRKEÄÄ: Television jalusta on koottava ennen käyttöä.

1. Aseta televisio näyttöpuoli alaspäin pehmeälle ja tasaiselle alustalle (peitto, vaahtomuovi, liina tms.), jotta televisio ei vahingoitu.
2. Kiinnitä jalusta television pohjaan 6 ruuvilla.

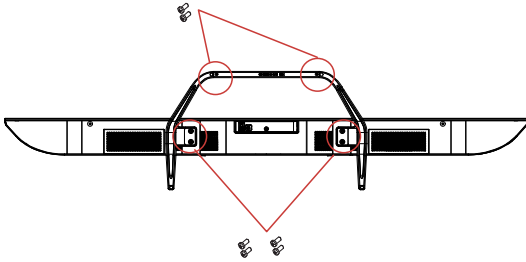

! HUOMAA

Tuotteen ulkonäön on oltava samankaltainen.

LED-TELEVISION VALMISTELU SEINÄASENNUKSEEN

Suosittellemme, että pidät television vähintään 60 mm:n etäisyydellä seinästä kaapelihäiriöiden välttämiseksi. Ennen television kiinnittämistä seinään sinun on poistettava jalusta.

Turvallisuutesi vuoksi käytä vain UL-luokiteltua seinäasennuskiinnikettä, joka kestää television vähimmäispainon ilman jalustaa.

Seinäasennuskiinnikkeen kiinnittäminen televisioon:

1. Irrota ruuvit, joilla televisio on kiinnitetty jalustaan.
2. Irrota jalusta televisiosta.
3. Kiinnitä seinäasennuskiinnike television taustaan neljällä ruuvilla. Noudata asennuksessa seinäkiinnityskiinnikkeen mukana toimitetun käyttöoppaan ohjeita.

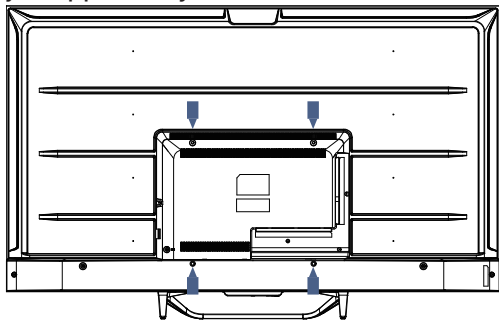

! HUOMAA

Seinäasennuskiinnike ei sisälly toimitukseen.

4. Kiinnitä seinäkiinnitysruuvit (M6x12 mm / 4 kpl) LED-television taustaan käyttäen vääntömomenttia 12 kgf, cm.

TELEVISION KYTKEMINEN PÄÄLLE

1. Asenna jalusta ja aseta televisio kiinteälle alustalle.

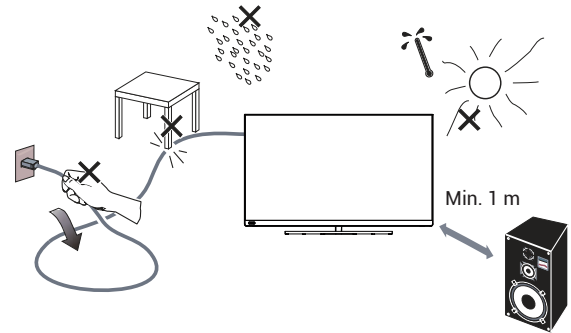

! HUOMAA

- Varmista, että televisio on sijoitettu siten, että ilma pääsee virtaamaan vapaasti. Älä peitä takakannen tuuletusaukkoja.
 - Turvattomien tilanteiden välttämiseksi avotulen lähteitä, kuten sytytettyjä kynttilöitä, ei saa asettaa laitteen päälle tai sen lähelle.
 - Vältä kuumuutta, suoraa auringonvaloa ja altistumista sateelle tai vedelle. Laitetta ei saa altistaa tippuvalle vedelle tai roiskeille.
2. Yhdistä antennijohto tai kaapelitelevision johto **ANT IN** -antenniliitäntään television takana.
 3. Kaukosäädin:
Poista paristolokeron kansi. Aseta 2 paristoa (tyyppi AAA 1,5 V).

VAROITUS: Tulipaloräjähdyksenvaara, jos paristo vaihdetaan väärän tyyppiseen.

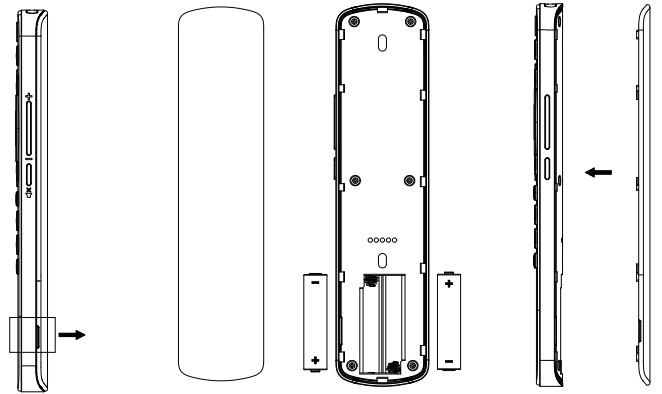

4. Virta:
Liitä johto toimivaan pistorasiaan.

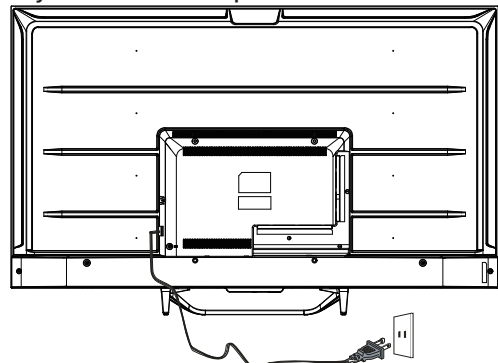

5. Kytke televisio päälle:
Paina  kaukosäätimestä tai **VIRTA**-painiketta television sivussa olevasta ohjauspaneelistä.

OHEISLAITTEIDEN LIITÄNTÄ JA SÄÄTIMET

PAINIKEOHJAUS

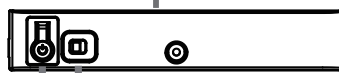
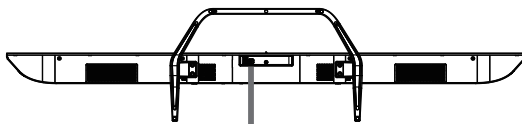
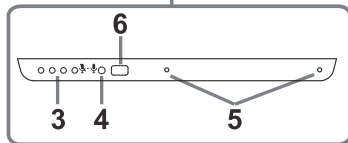
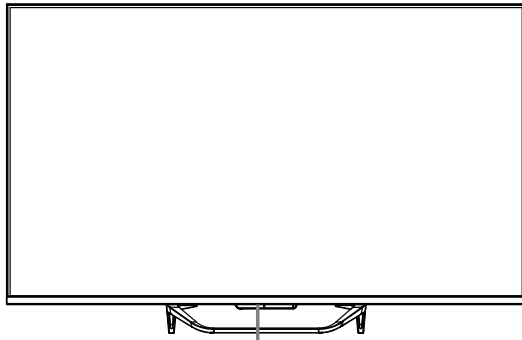

1 2

1. Virta päälle / virta pois päältä
2. Ääni päälle / ääni pois päältä
- 🗨️ Ota käyttöön Far Field Assistant
- 🗨️ Poista käytöstä Far Field Assistant

Käännä oikealle asettaaksesi sen päälle, merkkivalo syttyy ja sammuu sitten, äänitoiminto on käynnistetty. Voit sanoa "Ok Google" käyttääksesi äänitoimintoa. Merkkivalo syttyy, kun televisio vastaanottaa äänen, sano sitten suoraan pyyntösi. Käännä vasemmalle poistaaksesi sen käytöstä ja poistuaaksesi äänitoiminnosta. Merkkivalo palaa keltaisena.

3. Far Field Assistantin merkkivalo
4. Kaukosäätimen signaalin vastaanotin
5. Äänisignaalin vastaanotin
6. Virran LED-valo

! HUOMAA
Varmista, että televisio on liitetty Internetiin ennen kuin käytät Voice-äänitoimintoa. Aseta tilaksi On ennen kuin käytät Voice-äänitoimintoa. Kirjautu GOOGLE-tilillesi ennen Voice-äänitoiminnon käyttämistä.

VARUSTEET

Kaukosäädin – 1 kpl
Käyttäjän opas – 1 kpl
Ruuvit – 6 kpl
Pika-aloitusopas – 1 kpl
Takuukortti – 1 kpl

OHEISLAITTEIDEN LIITÄNTÄ



Kaikki liitännät (vasemmalta oikealle):
LAN, OPTINEN, VIDEO, L, R, HDMI4, HDMI3, HDMI2,



Kaikki liitännät (vasemmalta oikealle):
HDMI1 (eARC/ARC), LNB IN (SATELLIITTI), ANT IN (ANTENNI/KAAPELI), USB1, USB2, KUULOKKEET, CI.

LIITÄNTÖJEN TEKEMINEN

AV-LAITTEET

Tässä televisiossa on yksi AV-ryhmä, jonka avulla voit kätevästi liittää videonauhurin, DVD:n tai muun videolaitteen.

Tutustu myös liitettävien laitteiden käyttöohjeisiin.

Voit käyttää television takana olevia tuloliitäntöjä seuraavasti.

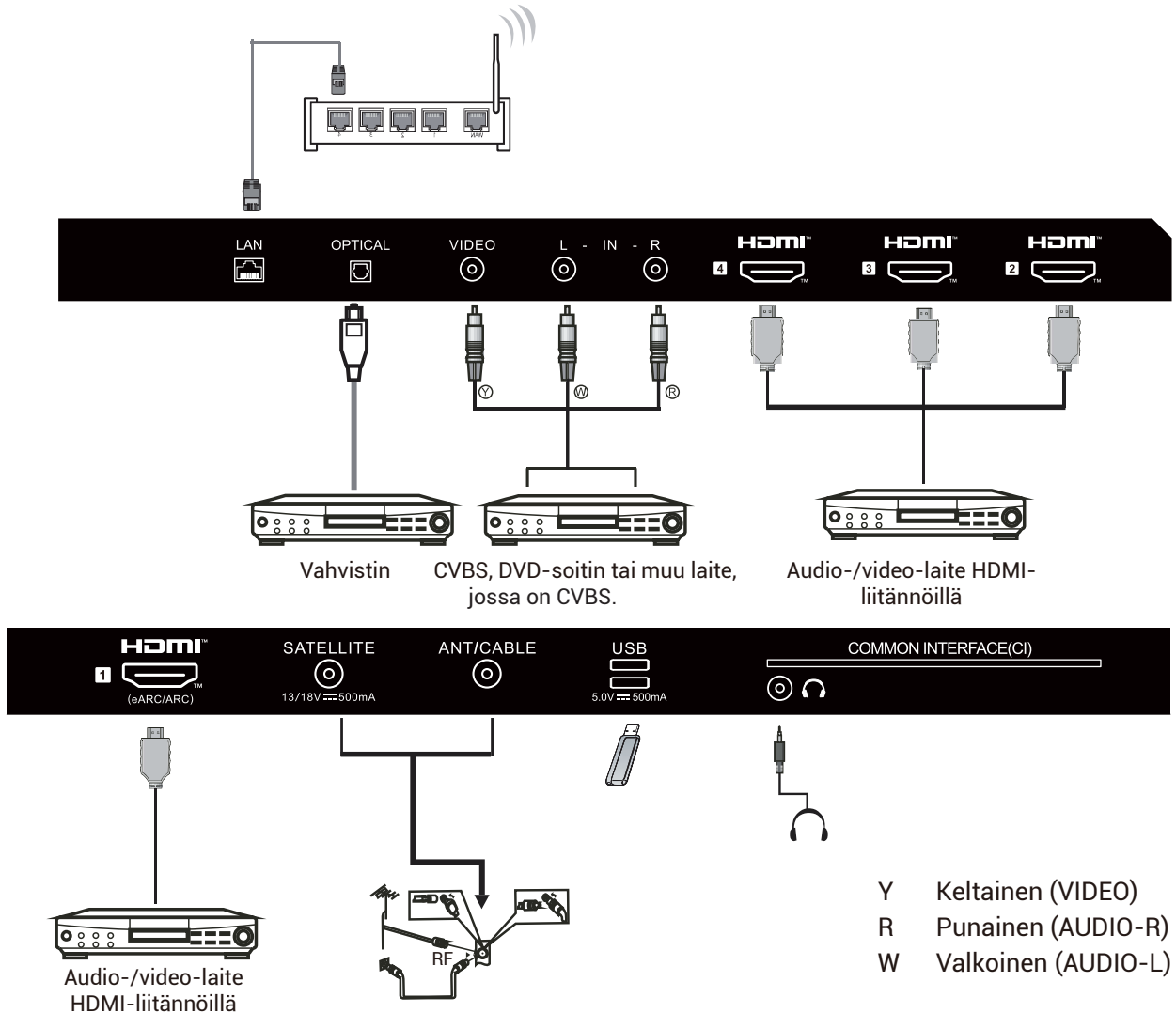

Siihen voidaan liittää seuraavat laitteet: Videonauhuri, monilevysoitin, DVD, videokamera, videopeli- tai stereojärjestelmä jne.

Huomaa:

Joskus tätä ei tueta eri laitteissa, koska laite syöttää epätyypillistä signaalia.

KÄYTTÖOHJEET

KAUKOSÄÄTIMEN KÄYTTÖ



Nro	Kohta	Kuvaukset
1	Virta	Kytkee television päälle tai pois päältä. Kun televisio on pois päältä, sen läpi kulkee edelleen virta. Jos haluat katkaista virran kokonaan, irrota virtajohdon pistoke pistorasiasta.
2		Painamalla avaat MAGIC BOARD -virtuaalinäppäimistön.
3		Painamalla voit avata tai sulkea näyttövalikon.
4		Painamalla pääset kohtaan Tilit ja Kirjautuminen Google-televisioon. (Perustelevisiota määritettäessä tällä näppäimellä ei ole vaikutusta)
5		Painamalla poistut näyttövalikosta.
6		Paluu edelliseen valikkoon.
7		Painamalla avaat aloitussivun.
8		Painamalla vaihdat televisiokanavia.
9	prime video	Painamalla prime video voit katsoa televisio-ohjelmia ja elokuvia verkossa (Internet-yhteys pakollinen).
10	TV	Painamalla avaat Live TV:n.
11		Painamalla avaat YouTube Music -palvelun.
12	NETFLIX	Painamalla avaat NETFLIXin.
13	MEDIA	Painamalla avaat multimediasoitimen.
14		Painamalla avaat Google Assistantin tai käynnistät äänihaun.
15		Painamalla avaat Asetukset-valikon.
16	VOL+VOL-	Painamalla VOL+ tai VOL- säädät äänenvoimakkuustasoa.
17	OK	Syötä valittu vaihtoehto tai suorita valittu toiminto.
18		Painamalla mykistät äänen tai poistat äänen mykistykseen.
19		Painamalla tätä näet elektronisen ohjelmaoppaan televisiotilassa.
20		Painamalla vaihdat televisiokanavia.
21		Painamalla avaat tulolähdeluettelon.
22		Painamalla toisto/tauko multimediatilassa.
23	AUDIO	Painamalla vaihdat ääniraitoja.
24		Painamalla avaat sovellukset.
25	YouTube	Painamalla avaat YouTuben.

KÄYTTÖOHJEET

ALKUASETUKSET

Kun käynnistät television ensimmäisen kerran, ohjattu asennustoiminto opastaa sinua perusasetusten määrittämisessä.

Noudata tekstivinkkiä Ensimmäisen kerran asetukset.

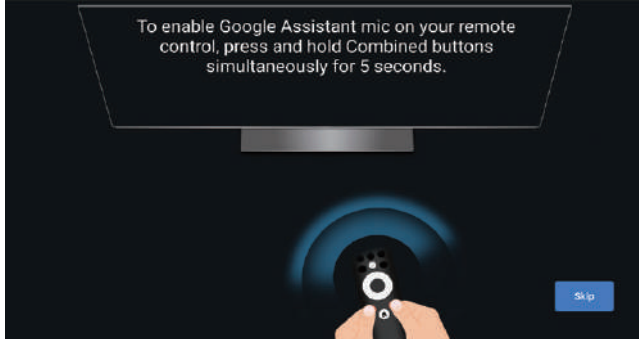

Tätä toimintoa käytetään kaukosäätimen parikoodausta varten. Kun parikoodi onnistuu, voit käyttää Bluetooth-kaukosäädintä television käyttämiseen.

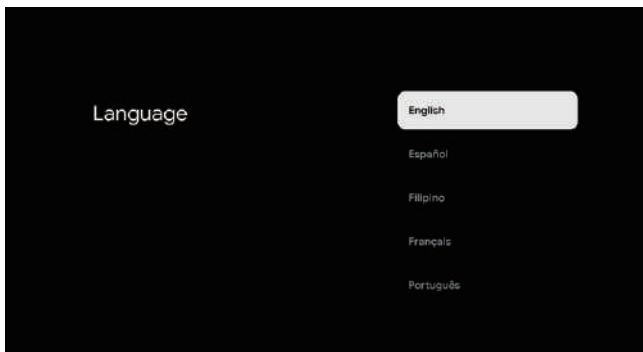

Painamalla ▲/▼ valitset järjestelmän kielen, vahvistat kielen valinnan painamalla OK-painiketta.

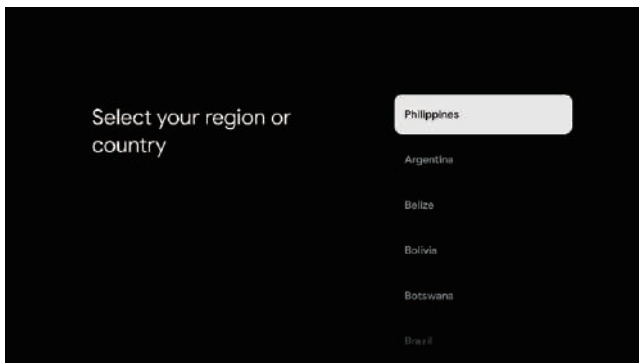

Painamalla ▲/▼ valitset oman maasi tai alueesi ja painamalla OK vahvistat valinnan.

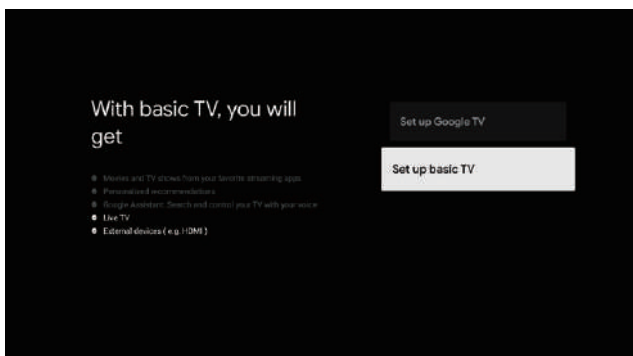

Painamalla ▲/▼ valitset "Set up basic TV" (Perustelevisiion asetukset) ja painamalla OK lopetat asetuksen.

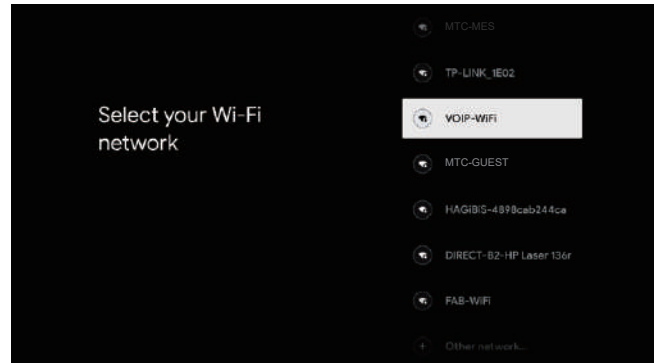

Painamalla ▲/▼ valitset Wi-Fi-verkon, painamalla OK ja antamalla salasanan vahvistat yhteyden onnistumisen.

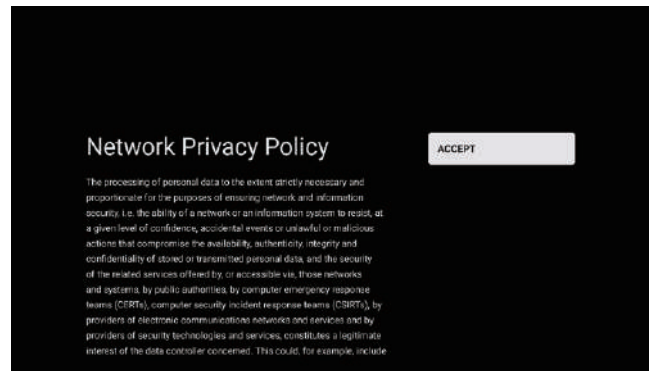

Valitse "Accept" (Hyväksy) hyväksyäksesi nämä verkon tietosuojakäytännön ehdot.

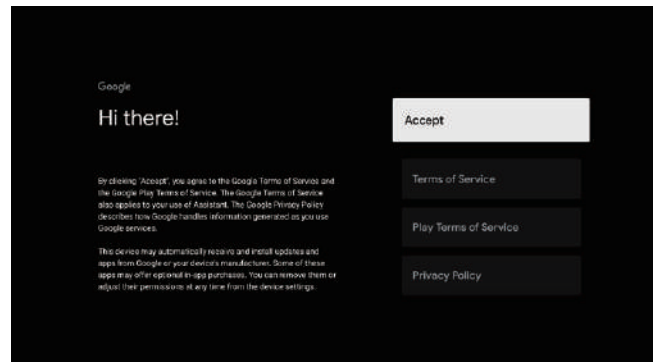

Hyväksyt Googlen palveluehdot tuotkokemuksen parantamiseksi valitsemalla "Accept" (Hyväksy).

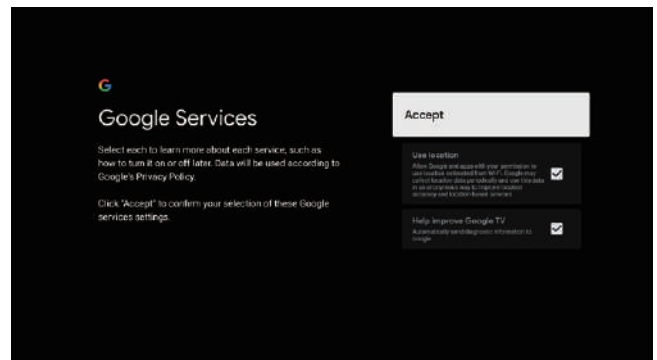

KÄYTTÖOHJEET

Hyväksyt Googlen palvelut tuotekokemuksen parantamiseksi valitsemalla "Accept" (Hyväksy).

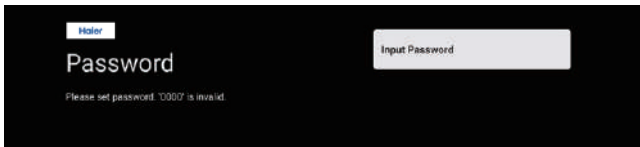

Käytetään laitteen salasanan asettamiseen turvallisuuden ja yksityisyyden varmistamiseksi.



Syötä 4-numeroinen salasana kaukosäätimen/näytön näppäimistöllä, siirryt automaattisesti seuraavaan näkymään.

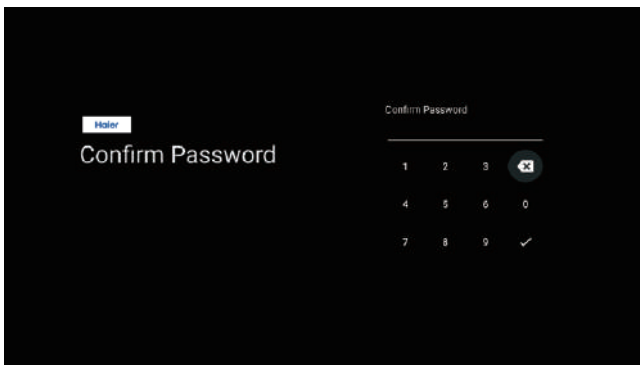

Vahvista salasana antamalla se uudestaan samassa muodossa. Käytä kaukosäätimen/näytön näppäimistöä salasanan antamisessa ja viimeistelyssä.

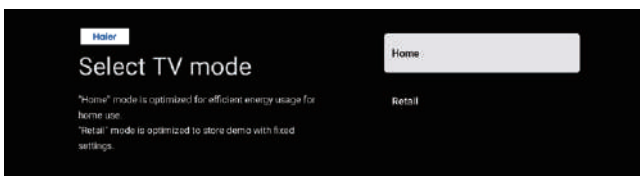

Valitse tilaksi Home (Koti) painamalla ▲/▼ ja paina sitten OK.

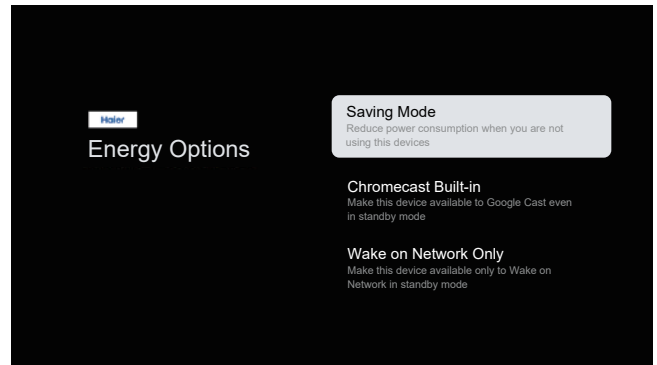

Valitse "Saving Mode" (Säästötila) ja jatka seuraavaan vaiheeseen.

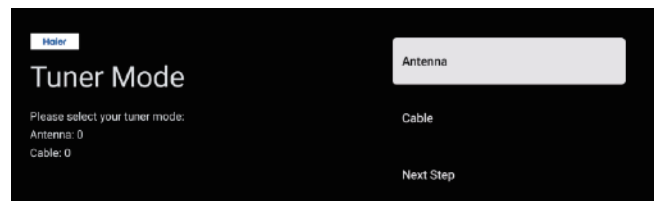

Valitse Tuner mode (Viritintila) hakua varten painamalla ja vahvista painamalla OK.

KÄYTTÖOHJEET

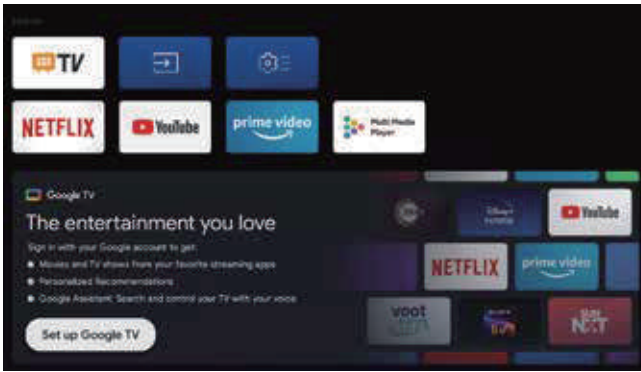

- Kun olet käyttöliittymässä, voit siirtyä perustelevisiosta Google TV -asetuksiin.



Painamalla ▲/▼ valitset "Set up Google TV" (Google-televisio-asetus) ja painamalla OK lopetat asetuksen.

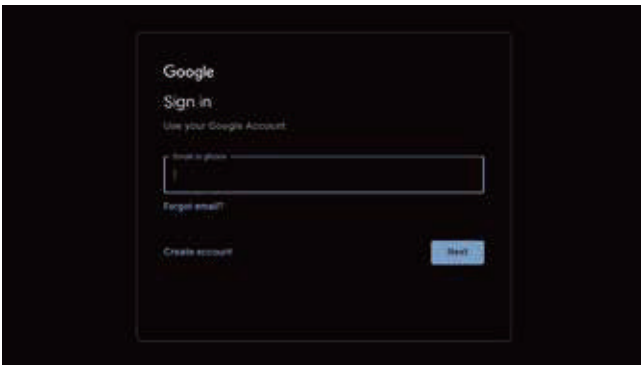

Käytä Google-tiliäsi kirjautumiseen

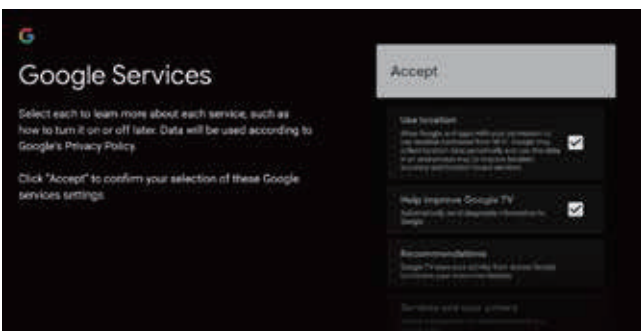
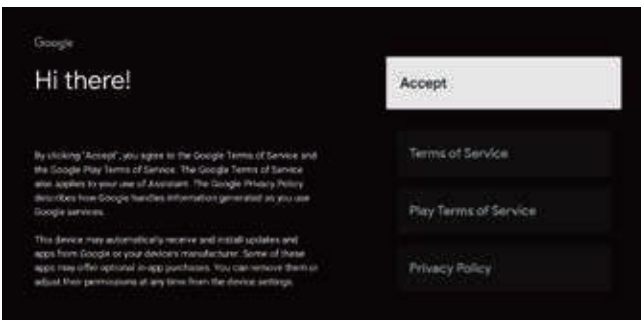

Hyväksyt Googlen palveluehdot tuotekokemuksen parantamiseksi valitsemalla "Accept" (Hyväksy).

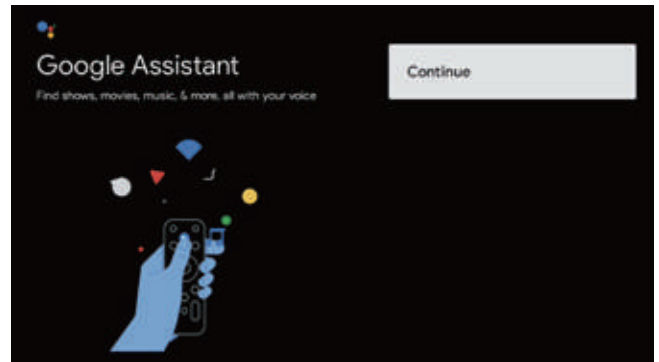

Valitse painamalla ja jatka painamalla OK.

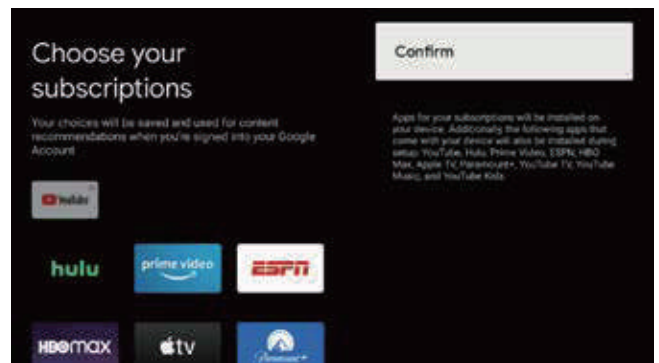

Painamalla ▲/▼ valitset Choose your subscriptions (Valitse tilauksesi), vahvista painamalla OK.

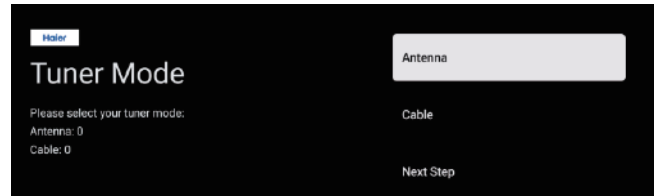

KÄYTTÖOHJEET

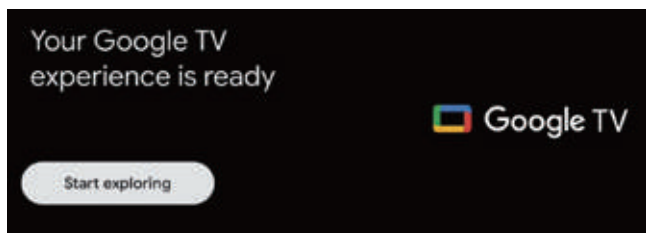

Google TV Experience is ready (Google TV on käyttövalmis), aloita käyttö painamalla OK.

ALOITUSNÄYTTÖ

Kun olet suorittanut ohjatut asetukset, voit katsella televisiota ja siirtyä aloitusnäyttöön.

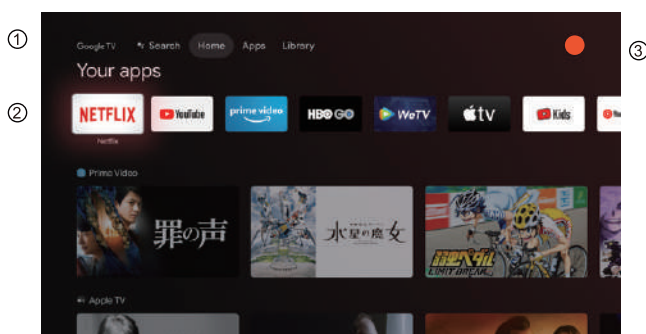

- ① **Search** Avaa Google Assistant tai käynnistä äänihaku.
Home Avaa television aloitussivu.
Apps Avaa asentamiesi sovellusten luettelo ja lisää suosikkisovelluksesi.
Library Näytä käyttäjätillillä ostettu ja vuokrattu sisältö.
- ② Luettelo asentamistasi sovelluksista ja asennettujen ohjelmien push-sisällöstä.
- ③ Avaa tilitiedot, asetukset, aika, syötteet ja kuva.
Asetukset: Tässä voidaan määrittää erilaisia asetuksia. Lisätietoja asetuksista on seuraavassa selityksessä.
Tulot: Tulolähteen valitsemiskuvake.
Kuva: Käyttäjä voi asettaa televisiokuvan. Yksityiskohtaiset ohjeet asettamiseen on sivulla 12.

LIKKUMINEN KUVARUUTUVALIKOSSA

Liikkumiseen on kaksi tapaa. Voit painaa ensin Live TV -näkyssä valikkopainiketta nähdäksesi television asetukset, valitse asetustila painamalla ▲/▼/◀/▶ ja vahvasta valinta painamalla OK. Toinen tapa on painaa KOTI-näkyssä ▶-näppäintä ja valita -kuvake, vahvasta painamalla OK.

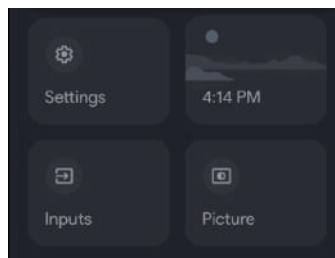
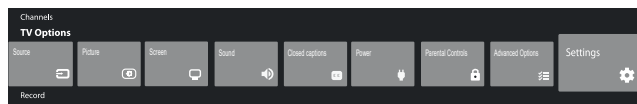

Painamalla ▲/▼ valitset sen, minkä haluat asettaa. Pääset asetukseen painamalla OK.

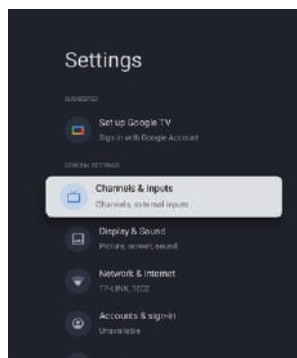

Palaa edelliseen valikkoon painamalla painiketta BACK (Takaisin).

Jos olet päävalikossa, painikkeen BACK (Takaisin) painaminen sulkee näyttövalikon.

KÄYTTÖOHJEET

KANAVAT

Menu -> Settings -> Channels & Inputs -> Channels
(Valikko->Asetukset->Kanavat ja tulot->Kanavat).

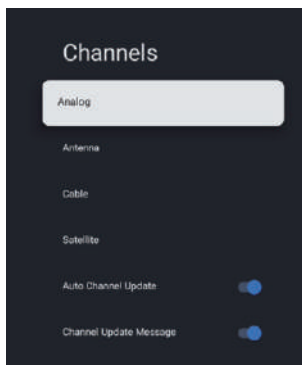

Analog/Antenna/Cable/Satellite (Analoginen/antenni/kaapeli/satelliitti) – valitse vaihtoehto painamalla painiketta ▲/▼ ja siirry alivalikkoon painamalla OK-painiketta.

Auto Channel Update (Automaattinen kanavapäivitys) – valitse ON/OFF (PÄÄLLE/POIS) painamalla OK-painiketta. Kun valitset ON (PÄÄLLE), järjestelmä etsii ja päivittää kanavat automaattisesti viiden minuutin valmistilassa olon jälkeen.

Channel Update Message (Kanavapäivitysviesti) – valitse ON/OFF (PÄÄLLE/POIS) painamalla OK-painiketta. Kun valitset ON (PÄÄLLE), järjestelmä näyttää päivitysviestin.

Huomautus: käytettävissä oleva lähde saattaa vaihdella mallista riippuen.

TULOT

Valikko->Asetukset->Kanavat ja tulot->Tulot

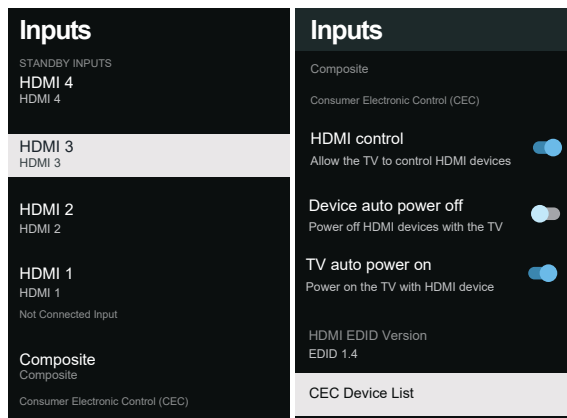

Inputs (Tulot) – Valitse vaihtoehto painamalla ▲/▼-painiketta ja siirry sitten alivalikkoon painamalla OK-painiketta.

HDMI control (HDMI-ohjaus) – Valitse vaihtoehto painamalla ▲/▼-painiketta ja valitse sitten ON/OFF painamalla OK-painiketta.

Device auto power off (Laitteen automaattinen sammutus) – Valitse vaihtoehto painamalla ▲/▼-painiketta ja valitse sitten ON/OFF painamalla OK-painiketta.

TV auto power on (Television automaattinen käynnistys) – Valitse vaihtoehto painamalla ▲/▼ ja valitse sitten ON/OFF painamalla OK-painiketta.

HDMI EDID Version (HDMI EDID -versio) – näyttää EDID-version.

CEC Device List (CEC-laiteluettelo) – Valitse vaihtoehto painamalla ▲/▼-painiketta ja siirry sitten alivalikkoon painamalla OK-painiketta.

NÄYTTÖ JA ÄÄNI

Valikko->Asetukset-> Näyttö ja ääni

Tässä valikossa voit asettaa television kuvan, äänen ja äänilähdön.

1. Painamalla ▲/▼ valitset sen, minkä haluat asettaa.
2. Vahvista painamalla OK-painiketta
3. Kun olet lopettanut säädön, palaa edelliseen valikkoon painamalla BACK (Takaisin) -painiketta.

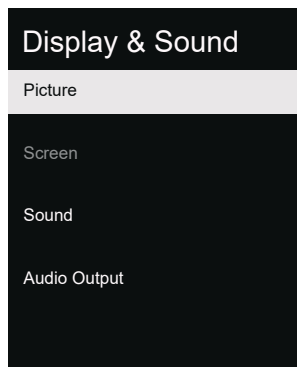

KÄYTTÖOHJEET

KUVA

Valikko->Asetukset-> Näyttö ja ääni-> Kuva.

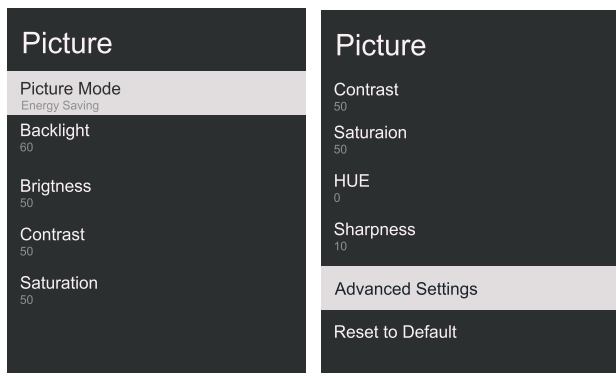

Picture Mode (Kuvatila) –

Painamalla ▲/▼ valitset vaihtoehdon, siirryt sitten alivalikkoon painamalla OK-painiketta. (Valittavissa: käyttäjä, vakio, värikäs, urheilu, elokuva, peli, virransäästö).

Backlight (Taustavalo) / Brightness (Kirkkaus) / Contrast (Kontrasti) / Saturation (Kylläisyys) / HUE (Värisävy) / Sharpness (Terävyys) – Valitse vaihtoehto painamalla ▲/▼ ja vahvista valinta painamalla OK-painiketta.

Pienennät parametria arvoa painamalla ◀. Suurennat parametria arvoa painamalla ▶.

Advanced Settings (Lisäasetukset) – Painamalla ▲/▼ valitset vaihtoehdon, siirryt sitten alivalikkoon painamalla OK-painiketta.

Reset to Default (Palauta oletusasetukset) – Palauttaa kaikki asetukset tehdasasetuksiin.

ÄÄNI

Valikko->Asetukset-> Näyttö ja ääni->Ääni.

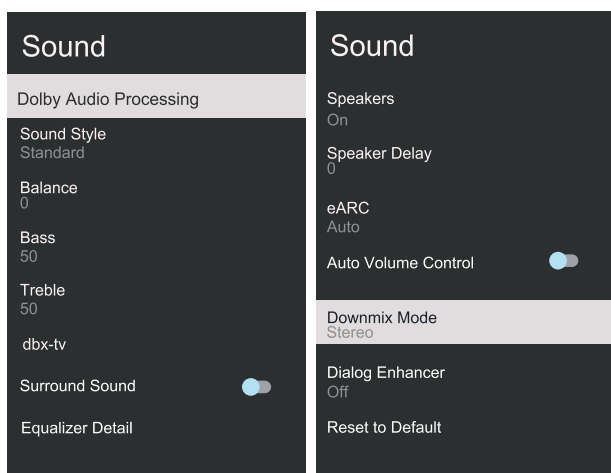

Dolby Audio processing (Dolby-äänenkäsittely) – Painamalla ▲/▼ valitset vaihtoehdon, siirryt sitten alivalikkoon painamalla OK-painiketta.

Sound style (Äänityyli) – Painamalla ▲/▼ valitset vaihtoehdon, siirryt sitten alivalikkoon painamalla OK-painiketta.

(Valittavissa: käyttäjä, vakio, yö, urheilu, elokuva, musiikki, uutiset).

Balance/ Bass/ Treble (Balanssi/Basso/Diskantti) – Painamalla ▲/▼ valitset vaihtoehdon ja siirryt sitten valintaan painamalla OK-painiketta.

Pienennät parametria arvoa painamalla ◀. Suurennat parametria arvoa painamalla ▶.

dbx-tv (dbx-tv) – Painamalla ▲/▼ valitset vaihtoehdon, siirryt sitten alivalikkoon painamalla OK-painiketta.

Surround Sound (Tilääni) – Painamalla ▲/▼ valitset vaihtoehdon ja valitse sitten ON/OFF painamalla OK-painiketta.

Equalizer Detail (Taajuuskorjaimen tiedot) – Painamalla ▲/▼ valitset vaihtoehdon, siirryt sitten alivalikkoon painamalla OK-painiketta.

Speakers (Kaiuttimet) – Painamalla ▲/▼ valitset vaihtoehdon ja valitse sitten ON/OFF painamalla OK-painiketta.

Speaker Delay (Kaiuttimien viive) – Painamalla ▲/▼ valitset vaihtoehdon ja siirryt sitten valintaan painamalla OK-painiketta.

Pienennät parametria arvoa painamalla ◀. Suurennat parametria arvoa painamalla ▶.

eARC (eARC) – Painamalla ▲/▼ valitset vaihtoehdon ja valitse sitten Automaattinen/OFF painamalla OK-painiketta.

Auto Volume Control (Automaattinen äänenvoimakkuuden säätö) – Valitse vaihtoehto painamalla ▲/▼-painiketta ja valitse sitten ON/OFF painamalla OK-painiketta.

Downmix Mode (Alasmiksaustila) – Painamalla ▲/▼ valitset vaihtoehdon, siirryt sitten alivalikkoon painamalla OK-painiketta. (Valittavissa: Stereo, Tilääni).

Dialog Enhancer (Keskustelun tehostin) – Painamalla ▲/▼ valitset vaihtoehdon, siirryt sitten alivalikkoon painamalla OK-painiketta. (Valittavissa: pois päältä, alhainen, keskitaso ja korkea).

Reset to Default (Palauta oletusasetukset) – Palauttaa kaikki asetukset tehdasasetuksiin.

ÄÄNILÄHTÖ

Valikko->Asetukset->Näyttö ja ääni-> Äänilähtö.

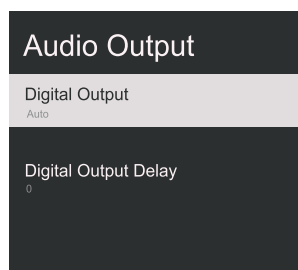

Digital Output (Digitaalinen lähtö) – Painamalla ▲/▼ valitset vaihtoehdon, siirryt sitten alivalikkoon painamalla OK-painiketta. (Valittavissa: automaattinen, ohitus, PCM, Dolby Digital Plus ja Dolby Audio-Dolby Digital).

Digital Output Delay (Digitaalisen lähdon viive) – Painamalla ▲/▼ valitset vaihtoehdon ja siirryt sitten valintaan painamalla OK-painiketta.

Pienennät parametria arvoa painamalla ◀. Suurennat parametria arvoa painamalla ▶.

KÄYTTÖOHJEET

VERKKO

Valikko->Asetukset->Verkko ja internet

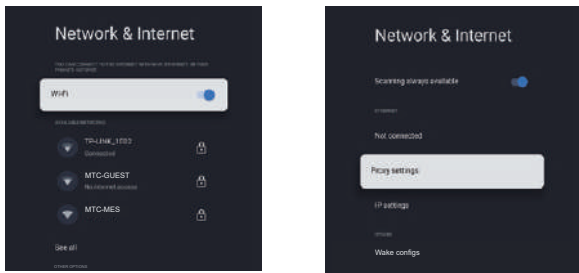

1. Painamalla ▲/▼ valitset sen, minkä haluat asettaa.
2. Vahvasta painamalla OK-painiketta.
3. Kun olet lopettanut säädön, tallenna ja palaa edelliseen valikkoon painamalla OK-painiketta.

TILIT JA KIRJAUTUMINEN

1. Valikko->Asetukset->Tilit ja kirjautuminen.
2. Painamalla HOME (Koti) -näkyvässä ▲/▼ valitset "Set up Google TV" (Google-television asetus) ja jatkat seuraavaan vaiheeseen.

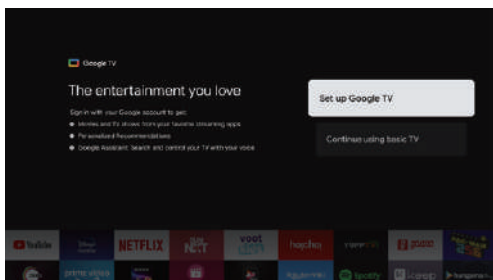

Valitse "Set up Google TV" (Google-television asetus) ja jatka seuraavaan vaiheeseen, anna tilisi ja salasanasi.

Noudata kehoitteita ja suorita tarvittavat asetukset loppuun.

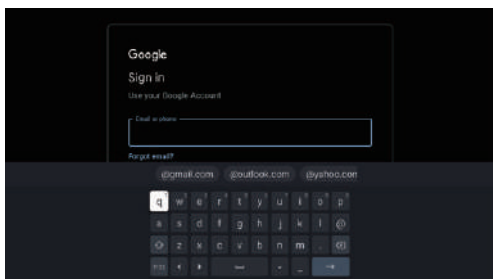

TIETOSUOJA

Valikko->Asetukset->Tietosuoja.

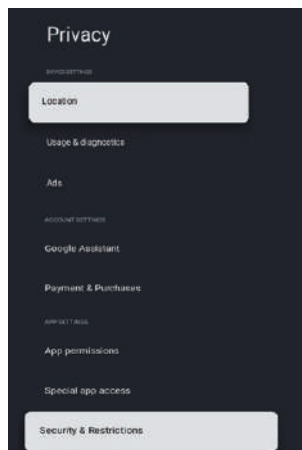

Tässä valikossa voit määrittää television sijainnin, käytön ja diagnostiikan jne.

1. Painamalla ▲/▼ valitset sen, minkä haluat asettaa.
2. Vahvasta painamalla OK-painiketta.
3. Kun olet lopettanut säädön, palaa edelliseen valikkoon painamalla BACK (Takaisin) -painiketta.

SIJAINTI

Valikko->Asetukset->Tietosuoja ->Sijainti.

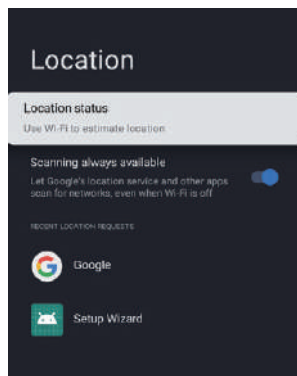

Location status (Sijainnin tila) – Painamalla ▲/▼ valitset vaihtoehdon, siirryt sitten alivalikkoon painamalla OK-painiketta. (Valittavissa: Käytä Wi-Fi-yhteyttä sijainnin arvioimiseen, Pois päältä)

Scanning always available (Kanavahaku aina käytettävissä) – Painamalla ▲/▼ valitset vaihtoehdon ja valitse sitten ON/OFF painamalla OK-painiketta.

KÄYTTÖ JA DIAGNOSTIIKKA

Valikko->Asetukset->Tietosuoja ->Käyttö ja diagnostiikka

KÄYTTÖOHJEET

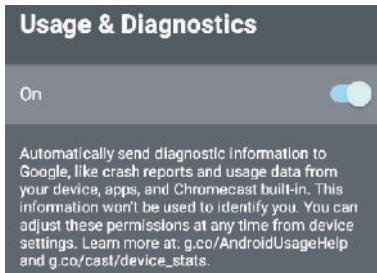

Usage & diagnostics (Käyttö ja diagnostiikka) – Painamalla ▲/▼ valitset vaihtoehdon ja valitse sitten ON/OFF painamalla OK-painiketta.

SOVELLUKSET

Valikko->Asetukset->Sovellukset.

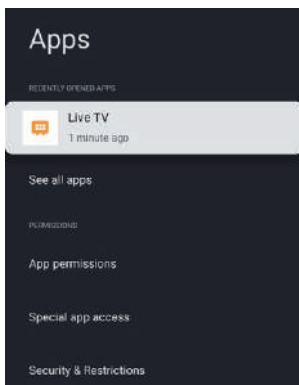

Tässä valikossa voit asettaa sovellusten käyttöoikeudet ja lukea sovellusluetteloita.

1. Painamalla ▲/▼ valitset sen, minkä haluat asettaa.
2. Vahvasta painamalla OK-painiketta.
3. Kun olet lopettanut säädön, palaa edelliseen valikkoon painamalla BACK (Takaisin) -painiketta.

JÄRJESTELMÄ

Valikko->Asetukset->Järjestelmä.

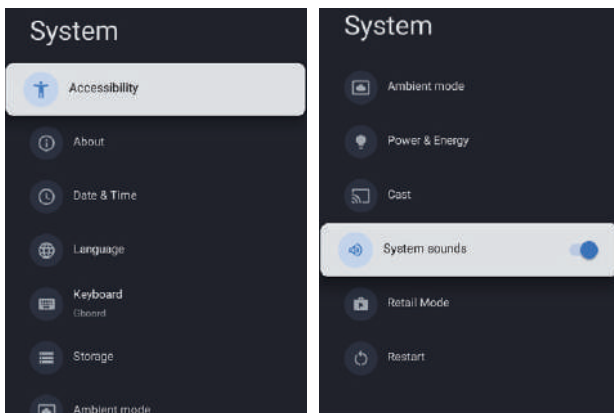

Tässä valikossa voit lukea television tietoja ja asetuksia.

1. Painamalla ▲/▼ valitset sen, minkä haluat asettaa.
2. Vahvasta painamalla OK-painiketta.
3. Kun olet lopettanut säädön, palaa edelliseen valikkoon painamalla BACK (Takaisin) -painiketta.

System sounds (Järjestelmän äänet) – Painamalla ▲/▼ valitset vaihtoehdon ja valitse sitten ON/OFF painamalla OK-painiketta. Lisätietoja järjestelmästä on seuraavassa selityksessä.

HELPPOKÄYTTÖTOIMINNOT

Valikko->Asetukset->Järjestelmä-> Helppokäyttö.

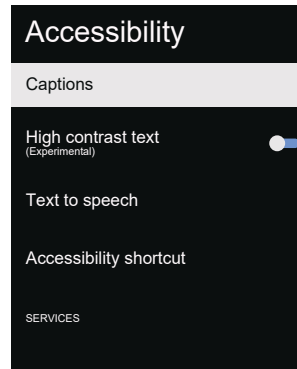

Captions (Tekstitykset) – Valitse vaihtoehto painamalla ▲/▼ -painiketta ja siirry sitten alivalikkoon painamalla OK-painiketta.

High contrast text (Suuren kontrastin teksti) – Valitse vaihtoehto painamalla ▲/▼ -painiketta ja valitse sitten ON/OFF painamalla OK-painiketta.

Text to speech (Teksti puheeksi) – Valitse vaihtoehto painamalla ▲/▼ -painiketta ja siirry sitten alivalikkoon painamalla OK-painiketta.

Accessibility shortcut (Helppokäyttöisyyden pikavalinta) – Valitse vaihtoehto painamalla ▲/▼ -painiketta ja siirry sitten alivalikkoon painamalla OK-painiketta.

TIETOJA

Valikko->Asetukset->Järjestelmä->Tietoja.

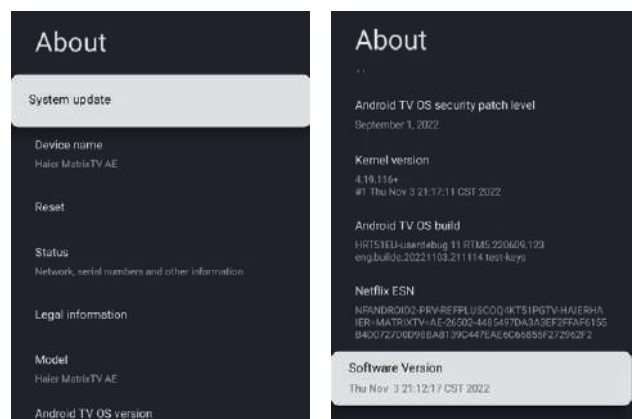

Tässä valikossa voit päivittää järjestelmän, nollata ja lukea television tietoja.

1. Painamalla ▲/▼ valitset sen, minkä haluat asettaa.
2. Vahvasta painamalla OK-painiketta.
3. Kun olet lopettanut säädön, palaa edelliseen valikkoon painamalla BACK (Takaisin) -painiketta.

KÄYTTÖOHJEET

PÄIVÄMÄÄRÄ JA AIKA

Valikko->Asetukset->Järjestelmä-> Päivämäärä ja aika.

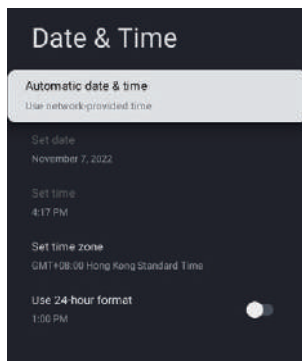

Automatic date & time (Automaattinen päivämäärä ja aika) – Painamalla ▲/▼ valitset vaihtoehdon, siirryt sitten alivalikkoon painamalla OK-painiketta. (Valittavissa: käytä verkon aikaa, pois päältä)

HUOMAA

- Kun Automatic date & time (Automaattinen päiväys ja aika) on tilassa OFF (POIS), voit käyttää Manuaalista päiväyksen ja ajan säätöä.

Set date (Aseta päivämäärä) – Painamalla ▲/▼ valitset vaihtoehdon, siirryt sitten alivalikkoon painamalla OK-painiketta.

Set time (Aseta aika) – Painamalla ▲/▼ valitset vaihtoehdon, siirryt sitten alivalikkoon painamalla OK-painiketta.

Set time zone (Aseta aikavyöhyke) – Painamalla ▲/▼ valitset vaihtoehdon, siirryt sitten alivalikkoon painamalla OK-painiketta.

Use 24-hour format (Käytä 24 tunnin muotoa) – Painamalla ▲/▼ valitset vaihtoehdon ja valitse sitten ON/OFF painamalla OK-painiketta.

KIELI

Valikko->Asetukset->Järjestelmä-> Kieli.

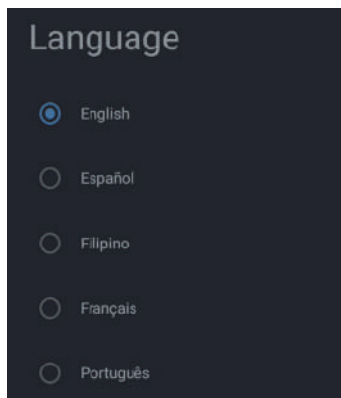

Language (Kieli) – Valitse vaihtoehto painamalla ▲/▼-painiketta ja vahvista sitten valittu kieli painamalla OK-painiketta.

NÄPPÄIMISTÖ

Valikko->Asetukset->Järjestelmä-> Näppäimistö.

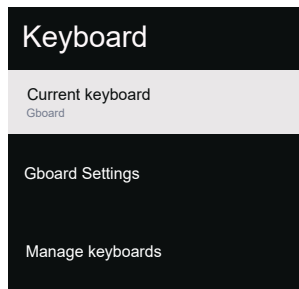

Current keyboard (Nykyinen näppäimistö) – Painamalla ▲/▼ valitset vaihtoehdon, siirryt sitten alivalikkoon painamalla OK-painiketta.

Gboard Settings (Gboard-asetukset) – Painamalla ▲/▼ valitset vaihtoehdon, siirryt sitten alivalikkoon painamalla OK-painiketta.

Manage keyboards (Hallinnoi näppäimistöjä) – Painamalla ▲/▼ valitset vaihtoehdon, siirryt sitten alivalikkoon painamalla OK-painiketta.

TALLENNUSTILA

Valikko->Asetukset->Järjestelmä->Tallennustila.

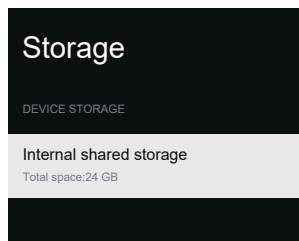

Internal shared storage (Sisäinen jaettu tallennustila) – Painamalla ▲/▼ valitset vaihtoehdon, siirryt sitten alivalikkoon painamalla OK-painiketta.

YMPÄRISTÖN TILA

Valikko->Asetukset->Järjestelmä-> Ympäristön tila.

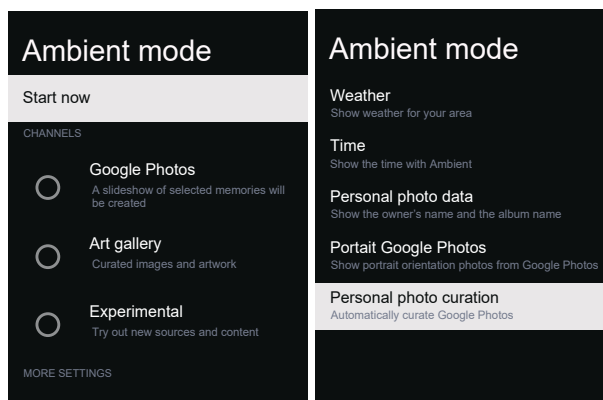

Tässä valikossa voit asettaa ympäristön tilan.

1. Painamalla ▲/▼ valitset sen, jonka haluat asettaa.
2. Vahvista painamalla OK-painiketta.
3. Kun olet lopettanut säädön, palaa edelliseen valikkoon painamalla BACK (Takaisin) -painiketta.

KÄYTTÖOHJEET

VIRTA JA ENERGIA

Valikko->Asetukset->Järjestelmä->Virta ja energia.

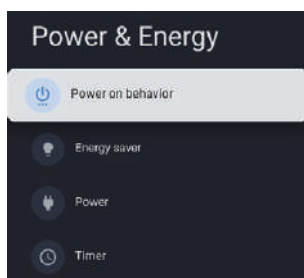

Tässä valikossa voit tehdä virta- ja energia-asetukset.

(power on behavior (päällekytkennän tila), energy saver (energiänsäästö), power and timer (virta ja ajastin))

1. Painamalla ▲/▼ valitset sen, minkä haluat asettaa.
2. Vahvasta painamalla OK-painiketta.
3. Kun olet lopettanut säädön, palaa edelliseen valikkoon painamalla BACK (Takaisin) -painiketta.

PÄÄLLEKYTKENNÄN TILA

Valikko->Asetukset->Järjestelmä->Virta ja energia->Päällekytkennän tila.

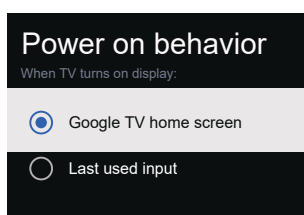

Painamalla ▲/▼ valitset vaihtoehdon ja vahvistat valinnan painamalla OK-painiketta.

ENERGIANSÄÄSTÖ

Valikko->Asetukset->Järjestelmä->Virta ja energia->Energiänsäästö.

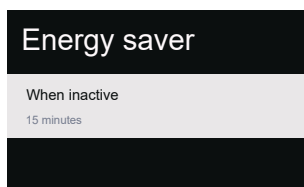

When inactive (Ei aktiivinen) – Painamalla ▲/▼ valitset vaihtoehdon, siirryt sitten alivalikkoon painamalla OK-painiketta.

(Valittavissa: 15 minuuttia, 20 minuuttia, 30 minuuttia, 1 tunti, 4 tuntia, 8 tuntia, 12 tuntia, 24 tuntia, ei koskaan).

VIRTA

Valikko->Asetukset->Järjestelmä->Virta ja energia->Virta.

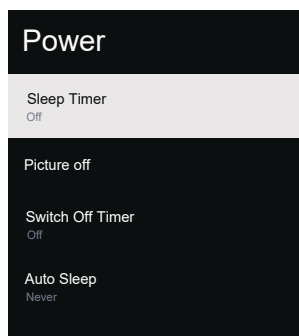

Sleep Timer (Uniajastin) – Painamalla ▲/▼ valitset vaihtoehdon, siirryt sitten alivalikkoon painamalla OK-painiketta.

(Valittavissa: pois päältä, 10 minuuttia, 20 minuuttia, 30 minuuttia, 40 minuuttia, 50 minuuttia, 60 minuuttia, 90 minuuttia, 120 minuuttia)

Picture off (Kuva pois) – Painamalla ▲/▼ valitset vaihtoehdon, vahvistat valinnan painamalla OK-painiketta.

Switch off timer (Poiskytkentäajastin) – Painamalla ▲/▼ valitset vaihtoehdon, siirryt sitten alivalikkoon painamalla OK-painiketta.

(Valittavissa: pois päältä, 30 minuuttia, 60 minuuttia, 90 minuuttia, 120 minuuttia, 150 minuuttia, 180 minuuttia, 210 minuuttia, 240 minuuttia)

Auto Sleep (Automaattinen lepotila) – Painamalla ▲/▼ valitset vaihtoehdon, siirryt sitten alivalikkoon painamalla OK-painiketta.

(Valittavissa: Ei koskaan, 4 tuntia, 6 tuntia, 8 tuntia)

AJASTIN

Valikko->Asetukset->Järjestelmä->Virta ja energia->Ajastin.

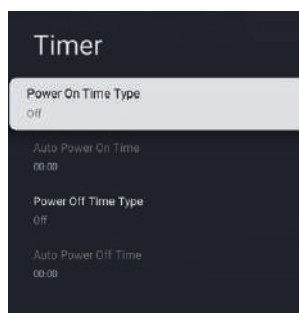

Power On Time Type (Virran kytkentätyyppi) – Painamalla ▲/▼ valitset vaihtoehdon ja valitse sitten OFF/ON/ONCE (POIS/PÄÄLLÄ/KERRAN) painamalla OK-painiketta.

Auto Power On Time (Automaattinen virran kytkentäaika) – Painamalla ▲/▼ valitset vaihtoehdon, siirryt sitten alivalikkoon painamalla OK-painiketta.

Power Off Time Type (Virran poiskytkentätyyppi) – Painamalla ▲/▼ valitset vaihtoehdon ja valitse sitten OFF/ON/ONCE (POIS/PÄÄLLÄ/KERRAN) painamalla OK-painiketta.

Auto Power Off Time (Automaattinen virran poiskytkentäaika) – Painamalla ▲/▼ valitset vaihtoehdon, siirryt sitten alivalikkoon painamalla OK-painiketta.

KÄYTTÖOHJEET

LÄHETYS

Valikko->Asetukset->Järjestelmä-> Lähetys.

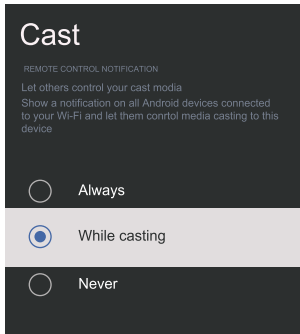

1. Painamalla ▲/▼ valitset sen, minkä haluat asettaa.
2. Vahvasta painamalla OK-painiketta.
3. Palaa edelliseen valikkoon painamalla BACK (Takaisin) -painiketta.

MYYMÄLÄTILA

Valikko->Asetukset->Järjestelmä-> Myymälätila.

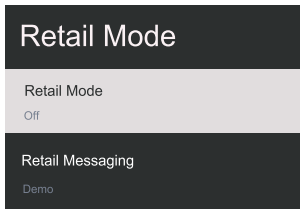

Retail mode (Myymälätila) – Painamalla ▲/▼ valitset vaihtoehdon ja valitse sitten ON/OFF painamalla OK-painiketta.

Retail messaging (Myyntiviestit) – Painamalla ▲/▼ valitset vaihtoehdon, siirryt sitten alivalikkoon painamalla OK-painiketta. (Huomaa: Demo, e-POP, e-POP + Demo)

UUELLEENKÄYNNISTYS

Valikko->Asetukset->Järjestelmä-> Uudelleenkäynnistys.

Siirryt alivalikkoon painamalla OK-painiketta. (Valittavissa: uudelleenkäynnistys ja peruuta)

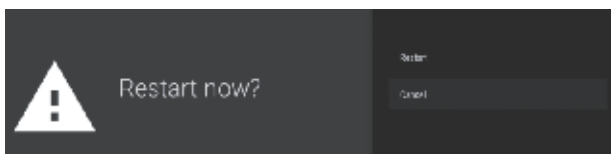

KAUKOSÄÄTIMET JA TARVIKKEET

Valikko->Asetukset-> Kaukosäätimet ja tarvikkeet.

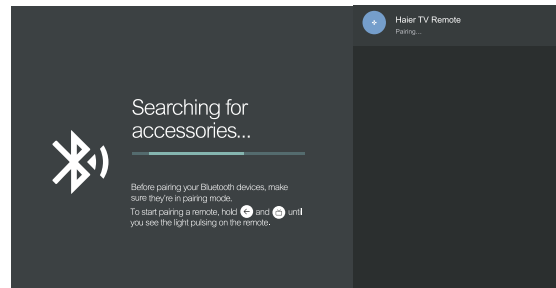
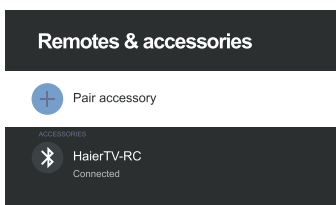

Tässä valikossa voit muodostaa Bluetooth-laitepareja.

1. Paina "←"- ja "☐"-painiketta kaukosäätimen alaosasta 5 sekunnin ajan.
2. Kun LED-valot alkavat vilkkua, vapauta ne. Kaukosäädin lähettää pariliitossignaalin televisioon ja näyttää kaukosäätimen tiedot näytön oikeassa reunassa.
3. Näet pariliitoksen painamalla OK-painiketta. Jos pariliitos näytetään, yhteys onnistui.
4. Jos pariliitosta ei ilmesty, yhteys epäonnistui. Odota 30 sekuntia ja paina sitten "←"- ja "☐"-painiketta kaukosäätimen alaosasta 5 sekunnin ajan toistaaksesi edelliset vaiheet.
5. Painamalla "←"-painiketta palaat edelliseen valikkoon.

MULTIMEDIASOITTIMEN KÄYTTÄMINEN

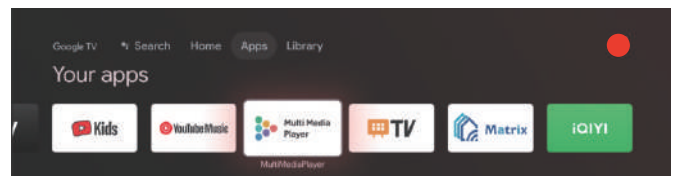

1. HOME (Koti) tai APPS (Sovellukset) -näkyvässä paina ▲/▼/◀/▶ valitaksesi multimediasoitimen käytön

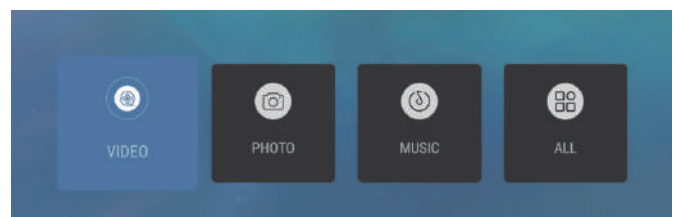

2. Valitsemalla OK siirryt multimediasoittimeen ja näkyviin tulee videot, valokuvat, äänet. Kun olet asettanut USB-muistitikun, voit tarkastella USB-muistitikun vastaavia tiedostoja (FAT32-muoto).

HUOMAA

Valikko voi olla erilainen riippuen siitä, milloin olet ostanut television.

VIANMÄÄRITYS

Tee nämä yksinkertaiset tarkistukset ennen huoltoon soittamista. Nämä vinkit voivat säästää aikaa ja rahaa, sillä takuu ei kata vastaanottimen asennuksesta ja asiakassäätimien säädöistä aiheutuvia kuluja.

Oireet	Tarkistettavat kohteet ja toimenpiteet
"Haamu" tai kaksoiskuva	<ul style="list-style-type: none">Ne saattavat aiheutua antennin esteestä, joka johtuu korkeista rakennuksista tai mäistä. Suunnattavan antennin käyttäminen saattaa parantaa kuvan laatua.
Ei virtaa	<ul style="list-style-type: none">Tarkista, että television vaihtovirtajohto on kunnolla kiinni liitännässä.Irrota televisio pistorasiasta ja odota 60 sekuntia. Laita sitten pistoke takaisin pistorasiaan ja käynnistä televisio uudelleen.
Ei kuvaa	<ul style="list-style-type: none">Tarkista, että television takana olevat antenniliitännät on yhdistetty kunnolla televisioon.Mahdollinen lähetyksiaseman vika. Kokeile toista kanavaa.Säädä kontrasti- ja kirkkausasetuksia.Tarkista piilotekestityksen säätö. Jotkin TEKSTI-tilat voivat estää näytön.
Hyvä kuva, mutta ei ääntä	<ul style="list-style-type: none">Varmista, että mykistys on pois päältä painamalla kaukosäätimen MYKISTYS-painiketta.
Hyvä ääni, mutta huonot värit	<ul style="list-style-type: none">Säädä kontrasti-, väri- ja kirkkausasetuksia.
Huono kuva	<ul style="list-style-type: none">Kuvanlaatu voi heikentyä, kun aktivoitu S-VHS-kamera tai videokamera on yhdistetty televisioon ja muihin oheislaitteisiin samanaikaisesti. Sammuta yksi oheislaitte.
Kuvassa lumisadetta ja kohinaa	<ul style="list-style-type: none">Tarkista antennin liitäntä.
Vaakasuuntainen pisteiviiva	<ul style="list-style-type: none">Tämä saattaa johtua sähköhäiriöstä (esim. hiustenkuivaajasta, lähellä olevista neonvaloista jne.). Sammuta laite.
Televisio ei vastaa kaukosäätimeen	<ul style="list-style-type: none">Tarkista toimivatko paristot. Vaihda tarvittaessa.Puhdista television kaukosäätimen anturin linssi.
Pikselit (pisteet), jotka ovat tummia tai aina kirkkaita	<ul style="list-style-type: none">Televisiosi on valmistettu tarkasti erittäin korkeatasoisella tekniikalla. Joskus pikselit eivät kuitenkaan näy oikein. Tämänäyttötyypiset tapahtumat ovat luontaisia tämänäyttötyypisille tuotteille, eivätkä ne merkitse viallista tuotetta.

HUOMAA

- Tässä tuotteessa käytetään alipikseleistä koostuvaa paneelia, jonka tuottaminen vaatii kehittyneitä tekniikkaa. Näytössä voi kuitenkin olla muutamia kirkkaita tai tummia pikseleitä. Nämä pikselit eivät vaikuta tuotteen suorituskykyyn.



Termit HDMI, HDMI High-Definition Multimedia Interface, HDMI Trade dress ja HDMI-logot ovat HDMI Licensing Administrator, Inc.:n tavaramerkkejä tai rekisteröityjä tavaramerkkejä.



Dolby, Dolby Vision, Dolby Atmos, Dolby Audio ja kaksois-D-symboli ovat Dolby Laboratories Licensing Corporation -yhtiön tavaramerkkejä. Valmistettu Dolby Laboratories myöntämällä lisenssillä. Luottamuksellisia julkaisemattomia teoksia. Copyright ©2012-2024 Dolby Laboratories. Kaikki oikeudet pidätetään.

TUOTTEEN TEKNISET TIEDOT

43" UHD LED -televisio

Television kuvanlaatu:	UHD Integroitu digitaalinen. Kuvaruudun koko: 108 cm Resoluutio 3840x2160 pikseliä 60 Hz.
TV-järjestelmä:	PAL-B/G, SECAM-B/G
DTV-viritin-dekooderi	DVB-T, DVB-C, DVB-T2, DVB-S2 16/32/64/128/256 QAM-modulaatio MPEG2, MPEG4, H.265
Liitettävyys:	1 Optinen portti 2 USB-porttia 1 LAN 4 HDMI-liitäntää 1 VIDEO-liitäntä 1 L-liitäntä 1 R-liitäntä 2 RF-liitäntää 1 KUULOKE-portti 1 CI-paikka Tuetut järjestelmät: PAL+SECAM Tallennustilan kanavanumero: 1000 (DTV), 100 (ATV) TV (RF): 75Ω epätasapaino AV-videotulo: 75 Ω, 1V-P, RCA AV-äänitulo: 20 KΩ, 500 mV RMS HDMI-videotulo: 480i, 480p, 720p, 1080i, 1080p, 2160p Wi-Fi: Standardi: IEEE 802.11 a/b/g/n/ac, Taajuus: 2,4 GHz / 5 GHz Bluetooth: V5.1
Äänenlaatu:	Stereo-äänijärjestelmä. 2 x 10 wattia RMS-lähtöteho.
Valmiustilan virrankulutus	≤0,5 W
Digitaaliset ominaisuudet:	Digitaalisesti vuorovaikutteinen. Digitaalinen teksti. Digitaalinen videolähetys (DVB), tekstitys käytettävissä. Automaattinen asetus. Automaattinen uusien kanavien haku. Meneillään olevan ja seuraavan ohjelman opas. 7 päivän elektroninen ohjelmaopas (EPG). CI-paikka Kuvailutulkkausyhteensopiva
Lisäominaisuudet:	UHF-/VHF-viritin; uniajastin; lapsilukko; kuva ja teksti Kaukosäätimen paristot 2 x AAA. VESA-kiinnikkeen koko: 300x300 mm Pakkauksen koko (LxKxS): 1075x652x142 mm Vastaanottimen koko (LxKxS) jalustan kanssa: 957,2x607,4x240,7 mm Vastaanottimen koko (LxKxS) ilman jalustaa: 957,2x566,7x86,6mm Pakkauksen paino: 10 kg Vastaanottimen paino jalustan kanssa: 7,2 kg Vastaanottimen paino ilman jalustaa: 6,8 kg

* Tässä esitetyt tämän televisiovastaanottimen tekniset tiedot ovat vain viitteellisiä.
Eroja voi esiintyä, kun tuotetekniikkaa päivitetään.
Muotoilu ja tekniset tiedot saattavat muuttua ilman ilmoitusta.

TUOTTEEN TEKNISET TIEDOT

50" UHD LED -televisio

Television kuvanlaatu:	UHD Integroitu digitaalinen. Kuvaruudun koko: 126 cm Resoluutio 3840x2160 pikseliä 60 Hz.
TV-järjestelmä:	PAL-B/G, SECAM-B/G
DTV-viritin-dekooderi	DVB-T, DVB-C, DVB-T2, DVB-S2 16/32/64/128/256 QAM-modulaatio MPEG2, MPEG4, H.265
Liitettävyyks:	1 Optinen portti 2 USB-porttia 1 LAN 4 HDMI-liitäntää 1 VIDEO-liitäntä 1 L-liitäntä 1 R-liitäntä 2 RF-liitäntää 1 KUULOKE-portti 1 CI-paikka Tuetut järjestelmät: PAL+SECAM Tallennustilan kanavanumero: 1000 (DTV), 100 (ATV) TV (RF): 75 Ω epätasapaino AV-videotulo: 75 Ω, 1V-P, RCA AV-äänitulo: 20 KΩ, 500 mV RMS HDMI-videotulo: 480i, 480p, 720p, 1080i, 1080p, 2160p Wi-Fi: Standardi: IEEE 802.11a/b/g/n/ac, Taajuus: 2,4 GHz / 5 GHz Bluetooth: V5.1
Äänenlaatu:	Stereo-äänijärjestelmä. 2 x 13.5 wattia RMS-lähtöteho.
Valmiustilan virrankulutus	≤0,5 W
Digitaaliset ominaisuudet:	Digitaalisesti vuorovaikutteinen. Digitaalinen teksti. Digitaalinen videolähetys (DVB), tekstitys käytettävissä. Automaattinen asetus. Automaattinen uusien kanavien haku. Meneillään olevan ja seuraavan ohjelman opas. 7 päivän elektroninen ohjelmaopas (EPG). CI-paikka Kuvailutulkkausyhteensopiva
Lisäominaisuudet:	UHF-/VHF-viritin; uniajastin; lapsilukko; kuva ja teksti Kaukosäätimen paristot 2 x AAA. VESA-kiinnikkeen koko: 300x300 mm Pakkauksen koko (LxKxS): 1250x760x144 mm Vastaanottimen koko (LxKxS) jalustan kanssa: 1111,2x710,5x277,2 mm Vastaanottimen koko (LxKxS) ilman jalustaa: 1111,2x651,8x88 mm Pakkauksen paino: 13,5 kg Vastaanottimen paino jalustan kanssa: 10 kg Vastaanottimen paino ilman jalustaa: 9,5 kg

* Tässä esitetyt tämän televisiovastaanottimen tekniset tiedot ovat vain viitteellisiä.
Eroja voi esiintyä, kun tuotetekniikkaa päivitetään.
Muotoilu ja tekniset tiedot saattavat muuttua ilman ilmoitusta.

TUOTTEEN TEKNISET TIEDOT

55" UHD LED -televisio

Television kuvanlaatu:	UHD Integroitu digitaalinen. Kuvaruudun koko: 139 cm Resoluutio 3840x2160 pikseliä 60 Hz.
TV-järjestelmä:	PAL-B/G, SECAM-B/G
DTV-viritin-dekooderi	DVB-T, DVB-C, DVB-T2, DVB-S2 16/32/64/128/256 QAM-modulaatio MPEG2, MPEG4, H.265
Liitettävyys:	1 Optinen portti 2 USB-porttia 1 LAN 4 HDMI-liitäntää 1 VIDEO-liitäntä 1 L-liitäntä 1 R-liitäntä 2 RF-liitäntää 1 KUULOKE-portti 1 CI-paikka Tuetut järjestelmät: PAL+SECAM Tallennustilan kanavanumero: 1000 (DTV), 100 (ATV) TV (RF): 75Ω epätasapaino AV-videotulo: 75 Ω, 1V-P, RCA AV-äänitulo: 20 KΩ, 500 mV RMS HDMI-videotulo: 480i, 480p, 720p, 1080i, 1080p, 2160p Wi-Fi: Standardi: IEEE 802.11 a/b/g/n/ac, Taajuus: 2,4 GHz / 5 GHz Bluetooth: V5.1
Äänenlaatu:	Stereo-äänijärjestelmä. 2 x 13,5 wattia RMS-lähtöteho.
Valmiustilan virrankulutus	≤0,5 W
Digitaaliset ominaisuudet:	Digitaalisesti vuorovaikutteinen. Digitaalinen teksti. Digitaalinen videolähetys (DVB), tekstitys käytettävissä. Automaattinen asetus. Automaattinen uusien kanavien haku. Meneillään olevan ja seuraavan ohjelman opas. 7 päivän elektroninen ohjelmaopas (EPG). CI-paikka Kuvailutulkkausyhteensopiva
Lisäominaisuudet:	UHF-/VHF-viritin; uniajastin; lapsilukko; kuva ja teksti Kaukosäätimen paristot 2 x AAA. VESA-kiinnikkeen koko: 300x300 mm Pakkauksen koko (LxKxS): 1350x837x144 mm Vastaanottimen koko (LxKxS) jalustan kanssa: 1225,8x777,3x277,2 mm Vastaanottimen koko (LxKxS) ilman jalustaa: 1225,8x719,4x88,1 mm Pakkauksen paino: 16,4 kg Vastaanottimen paino jalustan kanssa: 11,9 kg Vastaanottimen paino ilman jalustaa: 11,4 kg

* Tässä esitetyt tämän televisiovastaanottimen tekniset tiedot ovat vain viitteellisiä.
Eroja voi esiintyä, kun tuotetekniikkaa päivitetään.
Muotoilu ja tekniset tiedot saattavat muuttua ilman ilmoitusta.

TUOTTEEN TEKNISET TIEDOT

65" UHD LED -televisio

Television kuvanlaatu:	UHD Integroitu digitaalinen. Kuvaruudun koko: 164 cm Resoluutio 3840x2160 pikseliä 60 Hz.
TV-järjestelmä:	PAL-B/G, SECAM-B/G
DTV-viritin-dekooderi	DVB-T, DVB-C, DVB-T2, DVB-S2 16/32/64/128/256 QAM-modulaatio MPEG2, MPEG4, H.265
Liitettävyyks:	1 Optinen portti 2 USB-porttia 1 LAN 4 HDMI-liitäntää 1 VIDEO-liitäntä 1 L-liitäntä 1 R-liitäntä 2 RF-liitäntää 1 KUULOKE-portti 1 CI-paikka Tuetut järjestelmät: PAL+SECAM Tallennustilan kanavanumero: 1000 (DTV), 100 (ATV) TV (RF): 75 Ω epätasapaino AV-videotulo: 75 Ω, 1V-P, RCA AV-äänitulo: 20 KΩ, 500 mV RMS HDMI-videotulo: 480i, 480p, 720p, 1080i, 1080p, 2160p Wi-Fi: Standardi: IEEE 802.11a/b/g/n/ac, Taajuus: 2,4 GHz / 5 GHz Bluetooth: V5.1
Äänenlaatu:	Stereo-äänijärjestelmä. 2 x 13,5 wattia RMS-lähtöteho.
Valmiustilan virrankulutus	≤0,5 W
Digitaaliset ominaisuudet:	Digitaalisesti vuorovaikutteinen. Digitaalinen teksti. Digitaalinen videolähetys (DVB), tekstitys käytettävissä. Automaattinen asetus. Automaattinen uusien kanavien haku. Meneillään olevan ja seuraavan ohjelman opas. 7 päivän elektroninen ohjelmaopas (EPG). CI-paikka Kuvailutulkkausyhteensopiva
Lisäominaisuudet:	UHF-/VHF-viritin; uniajastin; lapsilukko; kuva ja teksti Kaukosäätimen paristot 2 x AAA. VESA-kiinnikkeen koko: 400x300 mm Pakkauksen koko (LxKxS): 1600x960x164 mm Vastaanottimen koko (LxKxS) jalustan kanssa: 1446,4x904,7x313,8 mm Vastaanottimen koko (LxKxS) ilman jalustaa: 1446,4x841,3x85,1 mm Pakkauksen paino: 24 kg Vastaanottimen paino jalustan kanssa: 17,2 kg Vastaanottimen paino ilman jalustaa: 16,5 kg

* Tässä esitetyt tämän televisiovastaanottimen tekniset tiedot ovat vain viitteellisiä.
Eroja voi esiintyä, kun tuotetekniikkaa päivitetään.
Muotoilu ja tekniset tiedot saattavat muuttua ilman ilmoitusta.

Haier

Haier

Une vie inspirée

Manuel de
l'utilisateur

MODÈLES :

H43Q80FUX

H50Q80FUX

H55Q80FUX

H65Q80FUX



Les illustrations de ce manuel sont fournies à titre indicatif et peuvent être différentes de l'apparence du produit réel.

La conception et les caractéristiques du produit sont modifiables sans préavis.

Téléviseur LED

TABLE DES MATIÈRES

1. INSTRUCTIONS DE SÉCURITÉ IMPORTANTES.....	1
2. PRÉPARATION	3
3. CONNEXION PÉRIPHÉRIQUE ET COMMANDES	4
4. CONNEXIONS	5
5. MODE D'EMPLOI	6
6. DÉPANNAGE.....	19
7. CARACTÉRISTIQUES DU PRODUIT	20



Les illustrations de ce manuel sont fournies à titre indicatif et peuvent être différentes de l'apparence du produit réel.

La conception et les caractéristiques du produit sont modifiables sans préavis.

INSTRUCTIONS DE SÉCURITÉ IMPORTANTES

- 1) Lisez ces instructions.
- 2) Conservez le présent manuel.
- 3) Respectez tous les avertissements.
- 4) Conformez-vous à toutes les instructions.
- 5) N'utilisez pas cet appareil près de l'eau.
- 6) Nettoyez uniquement avec un chiffon sec.
- 7) Ne bloquez pas les ouvertures de ventilation, installez le produit conformément aux instructions.
- 8) N'installez pas l'appareil à proximité d'une source de chaleur telle que radiateur, bouche de chaleur, cuisinière ou d'autres équipements (dont les amplificateurs) produisant de la chaleur.
- 9) N'essayez pas de contourner la fonction de sécurité de la fiche polarisée. Si la fiche fournie n'entre pas dans votre prise, consultez un électricien pour faire remplacer la prise obsolète.
- 10) Évitez que le cordon d'alimentation ne soit piétiné ou écrasé, surtout au niveau des fiches, et aux points de leur sortie de l'appareil.
- 11) N'utilisez que des pièces ou accessoires recommandés par le fabricant.
- 12) Débranchez l'appareil durant les orages et en cas d'inutilisation pendant de longues périodes.
- 13) Confiez toute réparation à un technicien qualifié. Une réparation est nécessaire lorsque l'appareil a été endommagé d'une manière ou d'une autre, par exemple si le cordon d'alimentation ou la prise est endommagé, si du liquide a été renversé sur l'appareil, si des objets sont tombés dans l'appareil, s'il a été exposé à la pluie ou à l'humidité, s'il ne fonctionne pas normalement ou s'il est tombé.
- 14) La fiche d'alimentation sert de dispositif de débranchement de l'appareil, elle doit rester facilement accessible.
- 15) Pour ne pas gêner la ventilation, les ouvertures de ventilation ne doivent pas être couvertes par des objets tels que journaux, nappes de table, rideaux, etc.
- 16) Aucune source de flamme nue, telle que des bougies allumées, ne doit être placée sur l'appareil.
- 17) Il convient de souligner les aspects environnementaux de l'élimination des piles.
- 18) L'appareil doit être utilisé sous un climat modéré.
- 19) L'appareil ne doit pas être exposé au ruissellement ni à la projection d'eau et aucun objet contenant un liquide, tel qu'un vase, ne doit être posé dessus.
- 20) Avertissement : pour éviter toute blessure causée par l'inclinaison du produit, assurez-vous toujours que l'ensemble du produit repose sur une surface plane.

*** L'aspect du produit réel peut être différent de celui présenté dans l'image ci-dessus*.**

Si la fiche du cordon d'alimentation est utilisée comme dispositif de débranchement, les instructions d'installation prévoient que, pour les équipements enfichables, la prise électrique doit être facilement accessible.

	ATTENTION RISQUE DE DÉCHARGE ÉLECTRIQUE NE PAS OUVRIR !	
ATTENTION POUR RÉDUIRE TOUT RISQUE DE DÉCHARGE ÉLECTRIQUE, NE DÉPOSEZ PAS LE CAPOT (OU LE PANNEAU ARRIÈRE). IL N'Y A AUCUNE PIÈCE RÉPARABLE PAR L'UTILISATEUR À L'INTÉRIEUR. CONFIEZ TOUTE RÉPARATION À UN TECHNICIEN QUALIFIÉ.		



Ce symbole indique que des tensions dangereuses présentant un risque d'électrocution sont présentes à l'intérieur de cet appareil.



Ce symbole indique que la documentation accompagnant cet appareil contient des instructions importantes concernant le fonctionnement et l'entretien de l'appareil.

AVERTISSEMENT :

Afin de réduire les risques d'incendie et de décharge électrique, n'exposez pas cet appareil à la pluie ou à l'humidité.

AVERTISSEMENT :

Les piles ne doivent pas être exposées à une chaleur excessive telle que rayons du soleil, feu, etc.



Ce symbole indique que ce produit dispose d'une double isolation entre les tensions dangereuses du secteur et les parties accessibles à l'utilisateur. En cas de réparation, n'utilisez que des pièces de rechange identiques.



Ce marquage indique que ce produit ne doit pas être jeté avec les ordures ménagères. Pour éviter tout effet nuisible possible à l'environnement et à la santé humaine causé par une mise au rebut incontrôlée des déchets, il est recommandé d'œuvrer au recyclage de ce produit de manière responsable pour encourager la réutilisation durable des ressources matérielles. Pour mettre au rebut votre appareil usé, utilisez les systèmes de retour et de collecte ou contactez le revendeur. Ils peuvent reprendre le produit pour qu'il soit recyclé, contribuant ainsi à la protection de l'environnement.

INSTRUCTIONS DE SÉCURITÉ IMPORTANTES

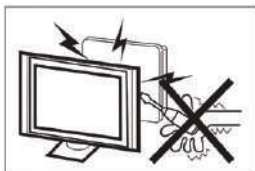

Des tensions élevées alimentent ce récepteur de télévision. Ne retirez pas le panneau arrière de l'appareil. Confiez toute réparation à un technicien qualifié.

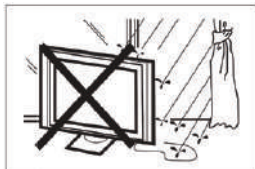

Pour éviter tout risque d'incendie ou d'électrocution, n'exposez pas le récepteur de télévision à la pluie ou à l'humidité.



Ne laissez pas tomber ou n'introduisez pas d'objets dans les fentes ou les ouvertures du boîtier du téléviseur. Ne renversez jamais de liquide sur le récepteur de télévision.



Ne bloquez pas les orifices de ventilation du panneau arrière. Une ventilation adéquate est essentielle pour éviter toute défaillance des composants électriques.



Ne coinciez pas le cordon d'alimentation sous le récepteur de télévision.



Si vous devez nettoyer le produit, débranchez le téléviseur, puis utilisez un tissu doux, sans eau, sans produits chimiques.



Ne montez jamais sur le téléviseur, ne vous appuyez pas dessus et ne le poussez jamais brusquement. Vous devez veiller tout particulièrement aux enfants. La chute de l'appareil peut entraîner des blessures graves.

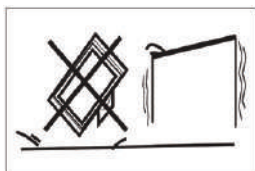

Ne placez pas le téléviseur sur un chariot, un support ou une table instable. La chute du téléviseur peut entraîner des blessures graves et endommager le téléviseur.

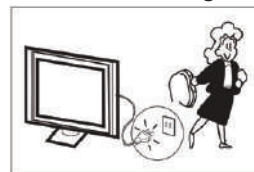

Si le récepteur de télévision n'est pas utilisé pendant une période prolongée, nous vous conseillons de débrancher le cordon d'alimentation de la prise secteur.

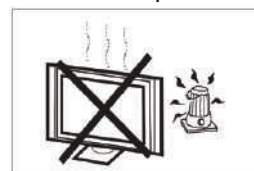

N'exposez pas le récepteur de télévision à la lumière directe du soleil et à d'autres sources de chaleur. Ne posez pas le récepteur de télévision directement sur d'autres produits dégageant de la chaleur, par exemple des lecteurs de cassettes vidéo et des amplificateurs audio. Ne placez aucune source de flamme nue, telle qu'une bougie allumée, sur le téléviseur.

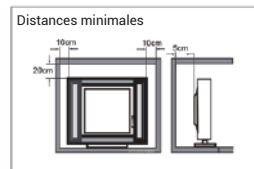

Si le téléviseur est installé dans un compartiment ou une armoire de ce type, il est indispensable de respecter les distances minimales. L'accumulation de chaleur risque de réduire la durée de vie de votre téléviseur et peut également s'avérer dangereuse.

Remarque : l'appareil doit être utilisé sous un climat modéré.

Attention :

Le téléviseur risque de tomber et causer des blessures graves, voire la mort. Il est possible d'éviter beaucoup de risques de blessure, en particulier aux enfants, en prenant des précautions élémentaires telles que :

- Utilisez TOUJOURS des armoires ou des supports de montage recommandés par le fabricant du téléviseur.
- Utilisez TOUJOURS des meubles pouvant supporter le téléviseur en toute sécurité.
- Veillez TOUJOURS à ce que le téléviseur ne déborde pas du meuble sur lequel il est posé.
- Expliquez TOUJOURS aux enfants qu'il est dangereux de tenter d'atteindre le téléviseur ou ses touches de commande en grimpant sur un meuble.
- Acheminez TOUJOURS les cordons et les câbles connectés à votre téléviseur de manière à ne pas trébucher dessus, à ne pas les tirer ou les happer.
- Ne placez JAMAIS un téléviseur sur un objet instable.
- Ne placez JAMAIS le téléviseur sur un meuble élevé (par exemple, armoire ou bibliothèque) sans fixer ce meuble et l'appareil à un support approprié.
- Ne placez JAMAIS de napperons ou d'autres pièces en tissu entre le téléviseur et le meuble sur lequel il est posé.
- Ne placez JAMAIS d'objets susceptibles d'inciter les enfants à grimper, comme des jouets ou des télécommandes, sur le dessus du téléviseur ou du meuble sur lequel il est posé.

Ces consignes doivent être respectées même avec un téléviseur existant.

PRÉPARATION

IMPORTANT : n'appliquez aucune pression sur la zone d'affichage de l'écran, sous peine de compromettre l'intégrité de l'affichage. La garantie du fabricant ne couvre pas les mauvais traitements infligés par l'utilisateur ou les installations incorrectes.

FIXATION DU SOCLE

IMPORTANT : le socle du téléviseur doit être monté avant l'utilisation.

1. Placez le téléviseur face vers le bas sur une surface douce et plane (couverture, mousse, tissu, etc.) pour éviter d'endommager le téléviseur.
2. Fixez le socle au pied du téléviseur à l'aide des 6 vis.

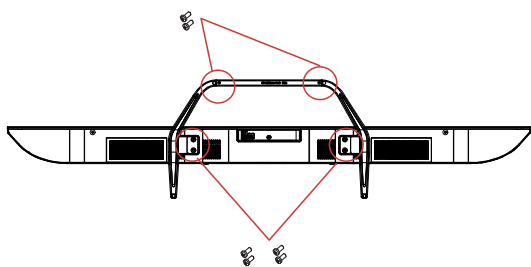

! REMARQUE :

L'aspect du produit doit être conforme à sa nature.

PRÉPARATION DE VOTRE TÉLÉVISEUR LED EN VUE D'UN MONTAGE MURAL

Nous vous conseillons d'éloigner votre téléviseur d'au moins 60 mm du mur afin d'éviter toute interférence avec les câbles. Avant de fixer votre téléviseur au mur, vous devez démonter le socle. Pour votre sécurité, n'utilisez qu'un support de fixation murale homologué UL en tenant compte du poids minimal du téléviseur sans socle.

Pour fixer un support mural à votre téléviseur :

1. Retirez les vis qui maintiennent le téléviseur sur son socle.
2. Retirez le socle de votre téléviseur.
3. Fixez le support mural à l'arrière du téléviseur à l'aide de quatre vis. Suivez les instructions du manuel d'utilisation fourni avec le support de fixation murale pour l'installer.

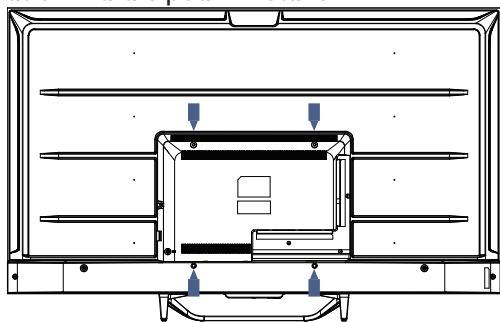

! REMARQUE :

Le support mural n'est pas inclus.

4. Fixez les vis de fixation murale (4 vis M6 x 12 mm) à l'arrière du téléviseur LED, en appliquant un couple de 12 kgf.cm.

ALLUMER LE TÉLÉVISEUR

1. Installez le socle, puis placez le téléviseur sur une surface solide.

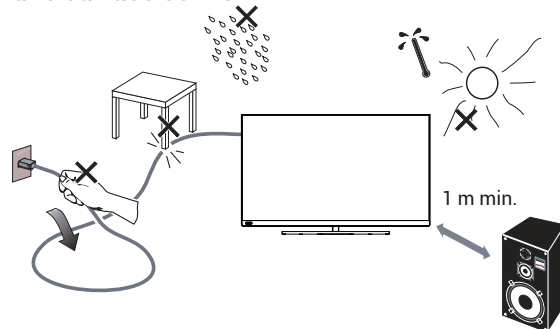

REMARQUE :

- Assurez-vous que le téléviseur est placé à un endroit qui permet à l'air de circuler librement. Ne couvrez pas les ouvertures de ventilation sur le panneau arrière.
 - Pour éviter toute situation dangereuse, aucune source de flamme nue, telle que des bougies allumées, ne doit être placée sur ou à proximité de l'appareil.
 - Évitez la chaleur, la lumière directe du soleil et l'exposition à la pluie ou à l'eau. L'équipement ne doit pas être exposé à des gouttes ou à des éclaboussures.
2. Branchez le câble d'antenne ou le câble de télévision par câble à la prise d'antenne **ANT IN** située à l'arrière du téléviseur.
 3. Télécommande : Retirez le couvercle du compartiment à piles. Insérez 2 piles (type AAA, 1,5 V).

ATTENTION : Risque d'explosion si la pile est remplacée par un type incorrect.

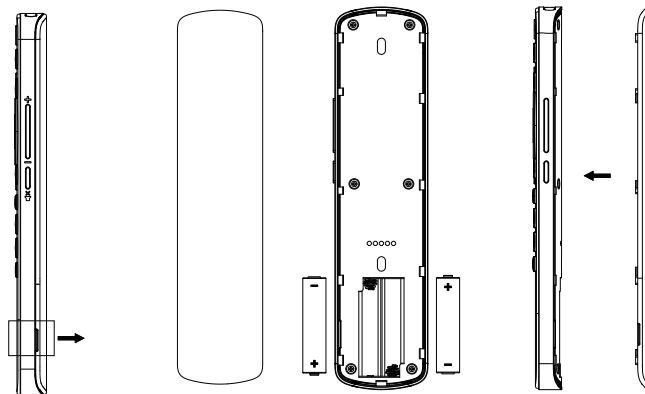

4. Alimentation : Branchez le cordon dans une prise électrique qui fonctionne.

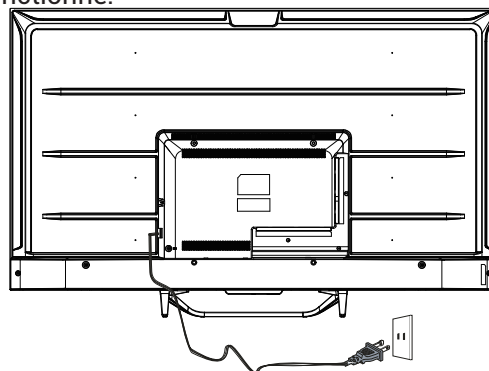

5. Allumer le téléviseur : Appuyez sur la touche **POWER** de la télécommande ou sur la touche **POWER** située sur le panneau de commande latéral du téléviseur.

CONNEXION PÉRIPHÉRIQUE ET COMMANDES

TOUCHE DE COMMANDE

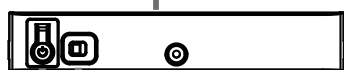
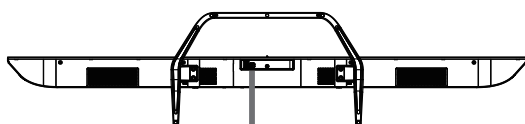
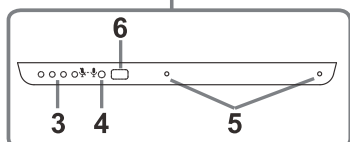
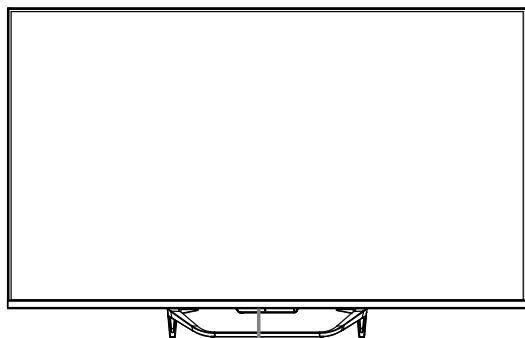

1. Allumer/Éteindre

2. Activation/Désactivation des commandes vocales

🗣️ Activation de l'assistant vocal

🗣️ Désactivation de l'assistant vocal

Placez le sélecteur sur « On » pour l'activer. Le voyant lumineux s'allume et s'éteint pour indiquer que la fonction vocale est en exécution. Il suffit de prononcer « Ok Google » pour utiliser la fonction vocale. Le voyant s'allume si le téléviseur reçoit la voix, et il suffit alors de formuler directement la demande.

Placez le sélecteur sur « Off » pour annuler la fonction vocale. Le voyant lumineux devient jaune.

3. Voyant lumineux de l'assistant vocal
4. Récepteur du signal de la télécommande
5. Récepteur du signal vocal
6. Voyant d'alimentation

REMARQUE :
Assurez-vous que le téléviseur est connecté à Internet avant d'utiliser les commandes vocales.
Placez le sélecteur sur « On » pour utiliser les commandes vocales.
Connectez-vous à votre compte Google avant d'utiliser les commandes vocales.

ACCESSOIRES

- 1 télécommande
- 1 manuel d'utilisation
- 6 vis
- 1 guide de démarrage rapide
- 1 carte de garantie

CONNEXION PÉRIPHÉRIQUE



Les ports sont les suivants (de gauche à droite) : LAN, OPTICAL, VIDEO, L, R, HDMI 4, HDMI 3, HDMI 2.



Les ports sont les suivants (de gauche à droite) : HDMI 1 (eARC/ARC), LNB IN (SATELLITE), ANT IN (ANTENNE/CÂBLE), USB 1, USB 2, EARPHONE, CI.

CONNEXIONS

ÉQUIPEMENT AUDIO-VIDÉO

Ce téléviseur est équipé d'un bloc de prises audio-vidéo pour une connexion pratique à un magnétoscope, à un DVD ou à d'autres équipements vidéo.

Veillez également consulter le manuel d'utilisation de l'équipement à connecter.

Utilisez les prises d'entrée situées à l'arrière du téléviseur comme suit.

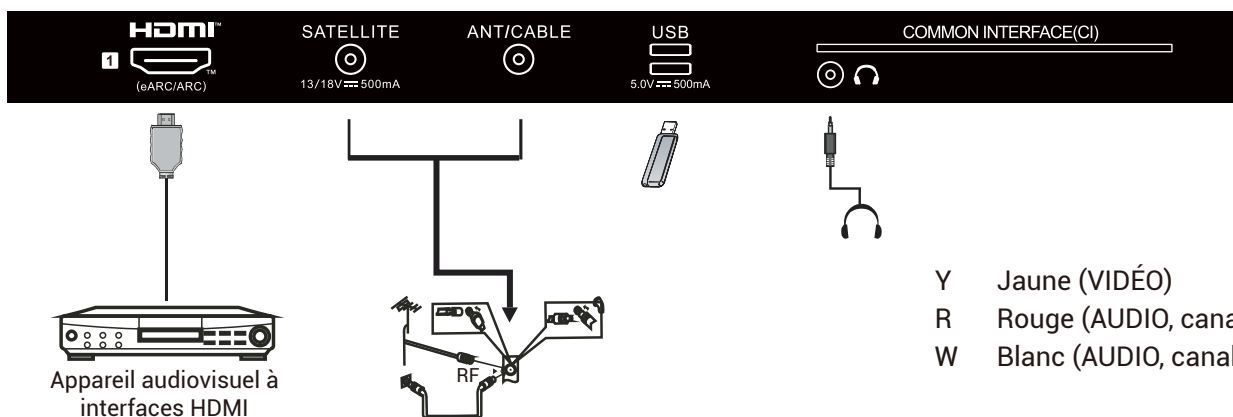
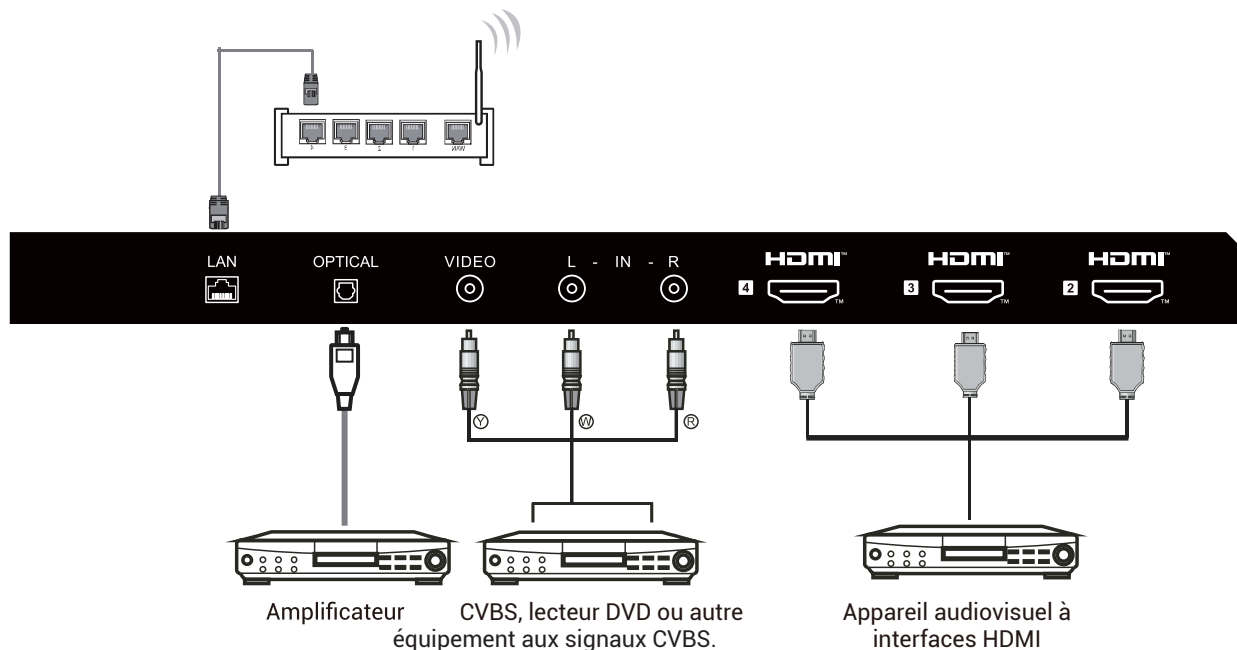

Les appareils suivants peuvent être branchés à l'appareil : magnétoscope (VCR), lecteur de disque/DVD, caméscope, console de jeux ou système stéréo, etc.

Remarque :

Il est possible que le signal ne soit pas pris en charge par un autre équipement parce que ce dernier fournit un signal non standard.

MODE D'EMPLOI

MODE D'EMPLOI DE LA TÉLÉCOMMANDE



N°	Élément	Descriptions
1	Alimentation	Appuyez sur cette touche pour allumer ou éteindre le téléviseur. Lorsque le téléviseur est éteint, il reste tout de même sous tension. Pour le mettre hors tension, débranchez le cordon d'alimentation.
2		Appuyez sur cette touche pour ouvrir MAGIC BOARD.
3		Appuyez sur cette touche pour ouvrir ou fermer le menu à l'écran.
4		Appuyez sur cette touche pour accéder/ connecter les comptes Google TV. (Lors de la configuration du téléviseur de base, cette touche est sans effet)
5		Appuyez sur cette touche pour parcourir le menu à l'écran.
6		Retourner au menu précédent.
7		Appuyez sur cette touche pour ouvrir la page d'accueil.
8		Appuyez sur cette touche pour changer de chaîne.
9		Appuyez sur cette touche pour accéder à Prime Video et regarder des émissions de télévision ou des films en ligne (connexion à Internet requise).
10		Appuyez sur cette touche pour regarder la télévision en direct.
11		Appuyez sur cette touche pour accéder à YouTube Music.
12		Appuyez sur cette touche pour accéder à NETFLIX.
13	MEDIA	Appuyez sur cette touche pour ouvrir le lecteur multimédia.
14		Appuyez sur cette touche pour ouvrir l'assistant Google et lancer une recherche par commande vocale.
15		Appuyez sur cette touche pour ouvrir le menu des paramètres.
16	VOL+/VOL-	Appuyez sur la touche VOL+ ou VOL- pour régler le volume.
17	OK	Cette touche permet de confirmer l'option ou l'opération sélectionnée.
18		Appuyez sur cette touche pour activer ou désactiver le son.
19		Appuyez sur cette touche pour afficher le guide électronique des programmes en mode TV.
20		Appuyez sur cette touche pour changer de chaîne.
21		Appuyez sur cette touche pour ouvrir la liste des sources d'entrée.
22		Appuyez sur cette touche pour mettre en lecture/pause en mode multimédia.
23	AUDIO	Appuyez sur cette touche pour changer de pistes audio.
24		Appuyez sur cette touche pour accéder aux applications.
25		Appuyez sur cette touche pour accéder à YouTube.

MODE D'EMPLOI

CONFIGURATION INITIALE

La première fois que vous allumez votre téléviseur, l'assistant de configuration vous guide dans le réglage des paramètres de base.

Veillez suivre les conseils donnés par le texte lors de la première installation.

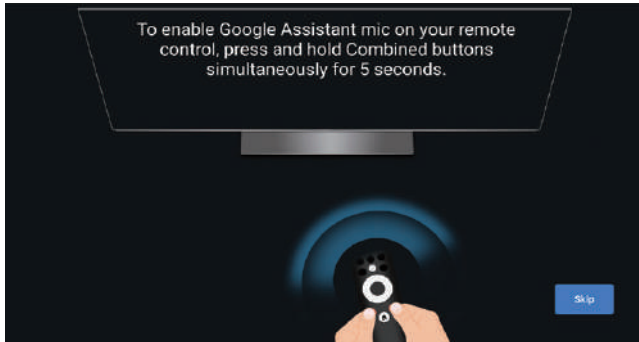

Cette fonction permet de définir le code de couplage de la télécommande. Une fois le code validé, la télécommande Bluetooth peut être utilisée pour commander le téléviseur.

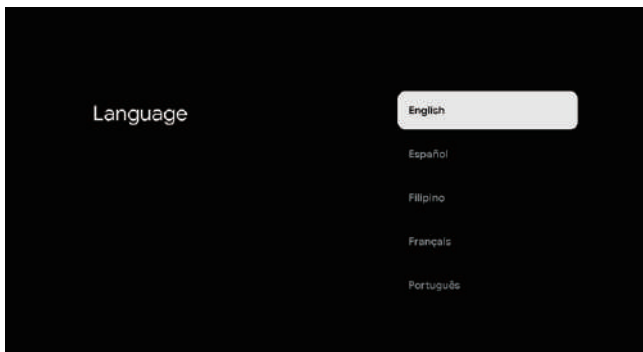

Appuyez sur les touches ▲/▼ pour sélectionner la langue du système, puis appuyez sur la touche OK pour confirmer la langue.

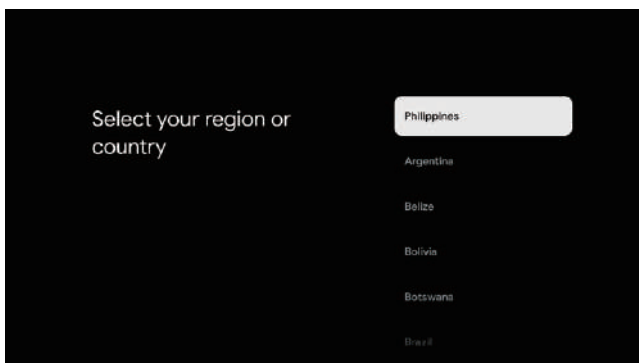

Appuyez sur les touches ▲/▼ pour sélectionner le pays/la région de votre appareil, puis appuyez sur la touche OK pour confirmer.

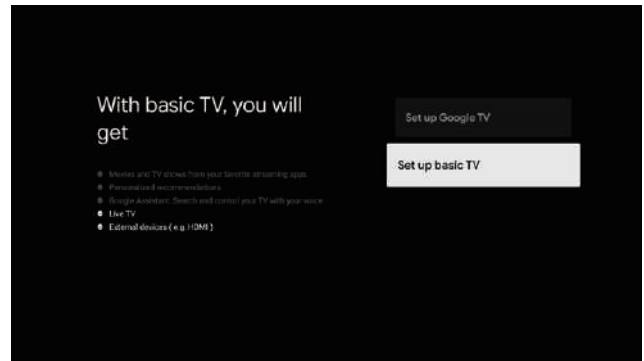

Appuyez sur les touches ▲/▼ pour sélectionner « Set up basic TV » (Configuration de base du téléviseur), puis appuyez sur la touche OK pour terminer la configuration.

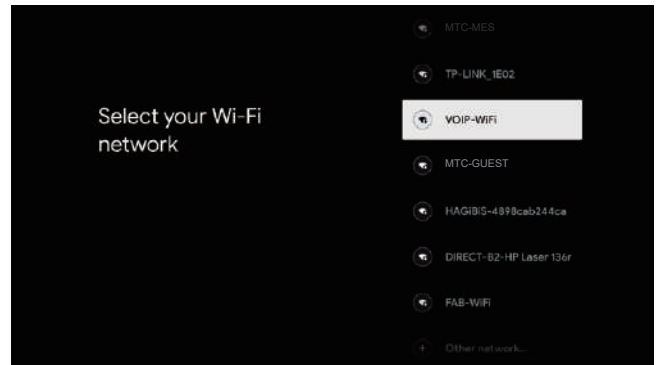

Appuyez sur les touches ▲/▼ pour sélectionner la connexion Wi-Fi, puis appuyez sur la touche OK pour saisir le mot de passe et confirmer la connexion.

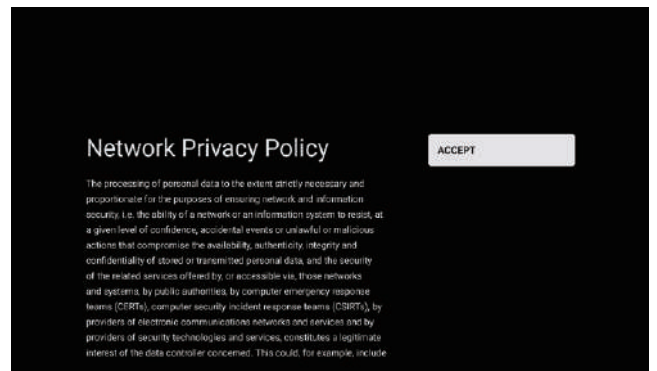

Sélectionnez « Accept » (Accepter) pour accepter les conditions de la Politique de confidentialité de réseau.

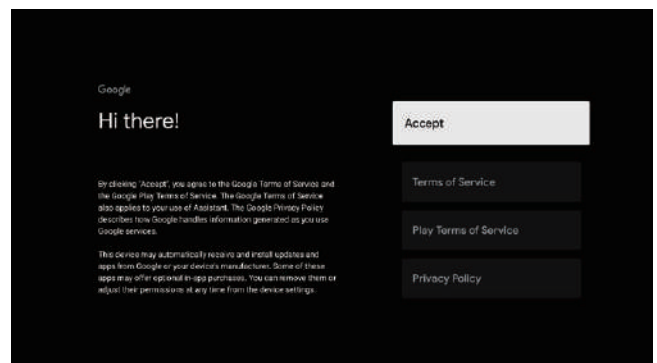

Si vous acceptez les conditions d'utilisation de Google, vous contribuerez à l'amélioration

MODE D'EMPLOI

du fonctionnement du produit. Dans ce cas, sélectionnez « Accept » (Accepter).

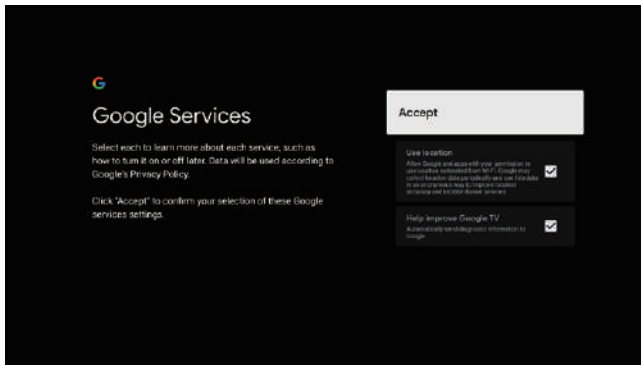

Si vous voulez utiliser les services Google, vous contribuerez à l'amélioration du fonctionnement du produit. Dans ce cas, sélectionnez « Accept » (Accepter).



Cet écran vous permet de définir le mot de passe de votre appareil pour assurer la sécurité et la confidentialité.

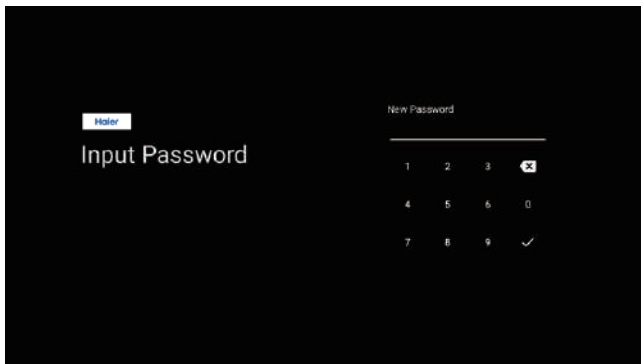

À l'aide de la télécommande/du clavier virtuel, saisissez le mot de passe à 4 chiffres pour accéder automatiquement à l'interface suivante.

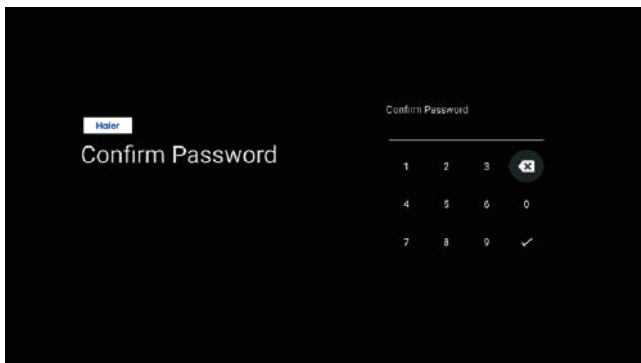

Confirmez à nouveau le mot de passe et veillez à ce qu'il soit identique. À l'aide de la télécommande/du clavier virtuel, resaisissez le mot de passe pour terminer.

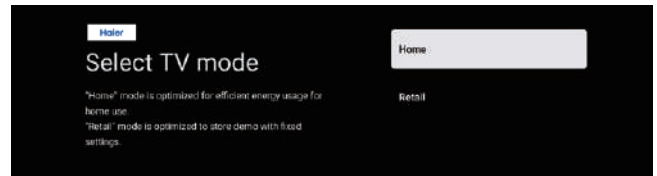

Pour sélectionner un mode, appuyez sur les touches ▲/▼ et choisissez le mode « Home » (Maison), puis appuyez sur la touche OK.

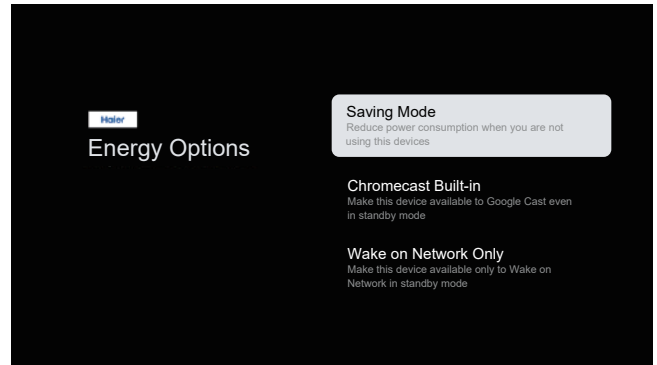

Sélectionnez le mode de fonctionnement « Saving Mode » (Mode économie), puis passez à l'étape suivante.

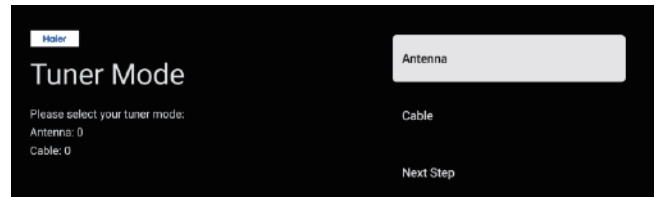

Sélectionnez un mode de syntonisation pour lancer la recherche des chaînes, puis appuyez sur la touche OK pour confirmer.

MODE D'EMPLOI

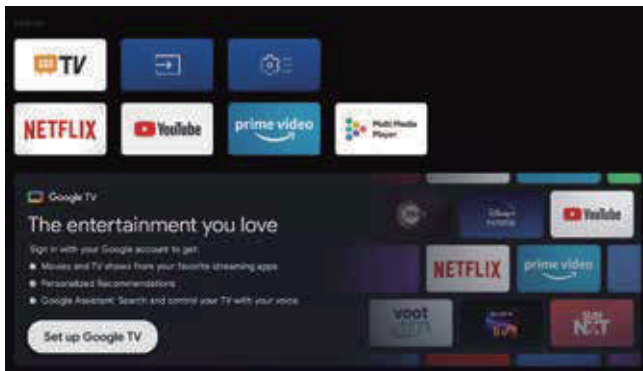

- Une fois arrivé à l'interface de l'utilisateur, choisissez une option entre les paramètres de base du téléviseur et les paramètres Google TV.

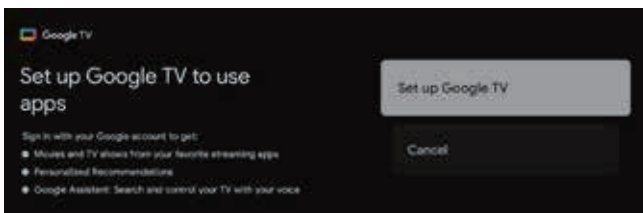

Appuyez sur les touches ▲/▼ pour sélectionner « Set up Google TV » (Configurer Google TV), puis appuyez sur la touche OK pour terminer la configuration.

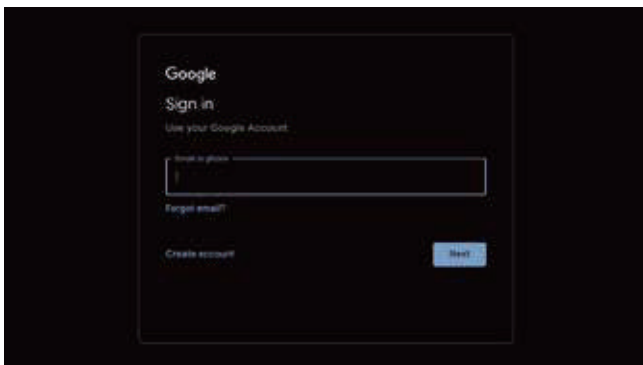

Utilisez la connexion à votre compte Google.

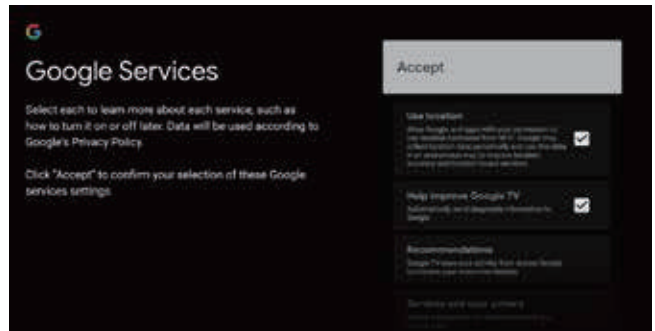
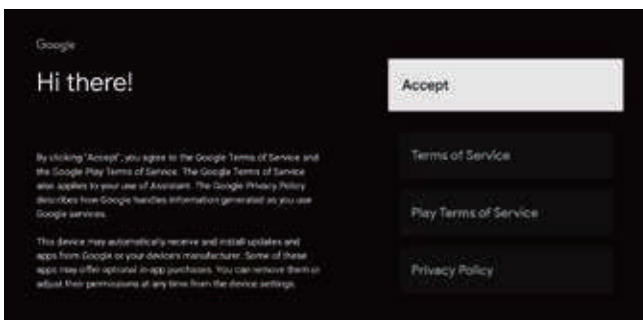

Si vous acceptez les conditions d'utilisation de Google, vous contribuerez à l'amélioration du fonctionnement du produit. Dans ce cas, sélectionnez « Accept » (Accepter).

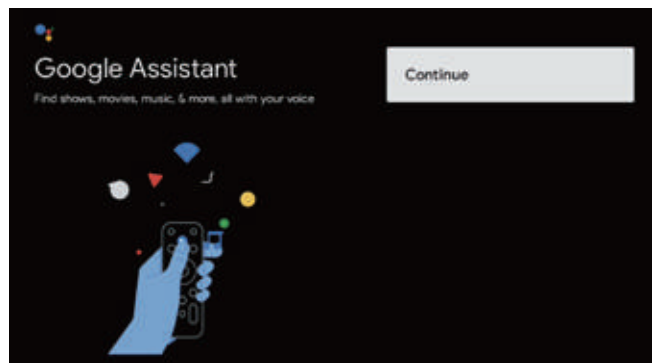

Appuyez sur le bouton « Continue » (Continuer), puis sur la touche OK pour confirmer.

MODE D'EMPLOI

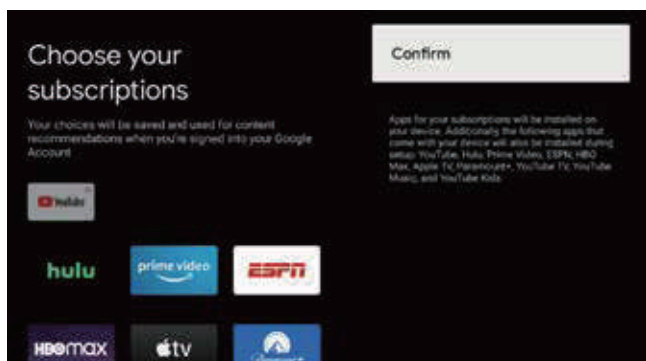

Appuyez sur les touches ▲/▼ pour sélectionner « Choose your subscriptions » (Choisir vos abonnements), puis appuyez sur la touche OK.

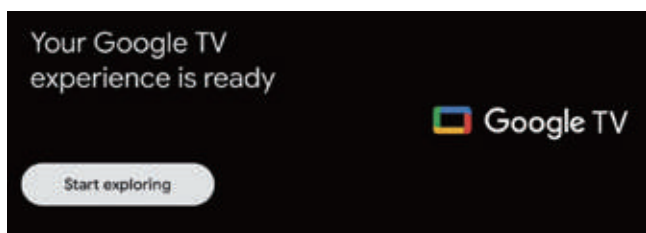
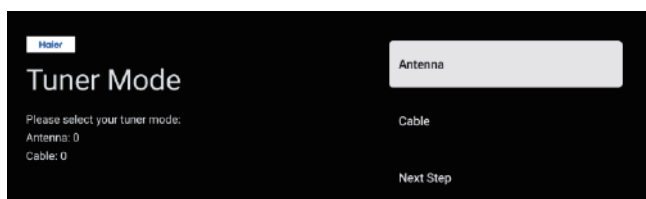

Votre expérience Google TV est désormais prête. Appuyez ensuite sur la touche OK pour valider l'option « Start exploring » (Commencer l'exploration).

ÉCRAN D'ACCUEIL

Après avoir terminé l'assistant de configuration, vous pourrez regarder la télévision ou accéder à l'écran d'accueil.

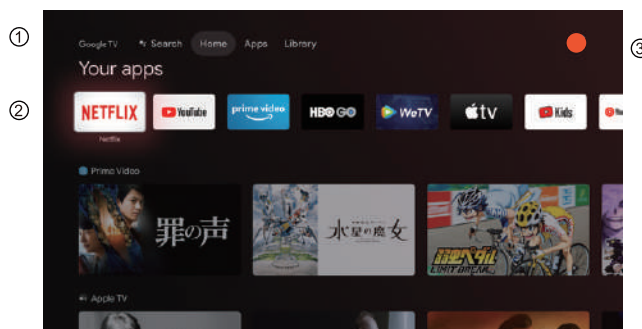

- ① **Search** Ouvrez l'assistant Google ou lancez une recherche par commande vocale.
Home Ouvrez la page d'accueil de votre téléviseur.
Apps Ouvrez la liste des applications que vous avez installées et ajoutez vos applications préférées.
Library Visionnez le contenu acheté ou emprunté sous votre compte.
- ② Liste des applications que vous avez installées et contenus en mode poussé des programmes installés.
- ③ Accédez à vos informations de compte, aux paramètres, à l'heure, aux entrées et aux images.
Paramètres : accédez à la configuration des différents paramètres. Pour plus de détails sur les paramètres, reportez-vous à leur explication ci-après.
Entrées : sélectionnez une icône représentant une source d'entrée.
Image : l'utilisateur peut régler l'image du téléviseur. Reportez-vous à la page 12 pour des instructions détaillées sur la configuration.

MODE D'EMPLOI

PARCOURIR LE MENU À L'ÉCRAN

Accédez à ce menu de deux manières. Première méthode : en mode télévision en direct, appuyez sur la touche de menu pour afficher les options du téléviseur. Appuyez sur les touches ▲/▼/◀/▶ pour sélectionner le menu des paramètres, puis appuyez sur la touche **OK** pour confirmer. Deuxième méthode : à partir de la page d'accueil, appuyez sur la touche ▶ pour sélectionner l'icône de menu ⚙️, puis appuyez sur la touche **OK** pour confirmer.

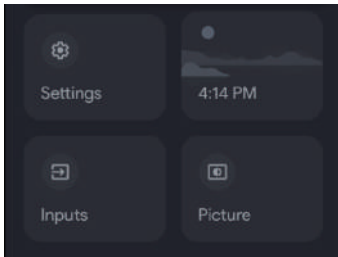
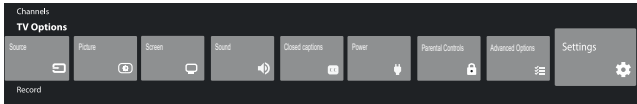

Appuyez sur les touches ▲/▼ pour sélectionner l'option que vous désirez régler. Appuyez sur la touche **OK** pour accéder au paramètre.

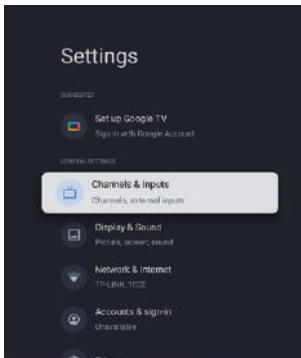

Appuyez sur la touche de retour pour revenir au menu précédent. Si le menu principal est affiché, appuyez sur la touche de retour pour fermer le menu à l'écran.

CHAÎNES

Menu->Settings->Channels & Inputs->Channels (Menu -> Paramètres -> Chaînes et entrées -> Chaînes)

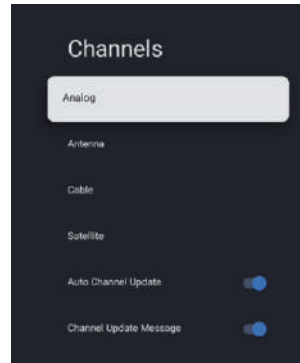

Analog/Antenna/Cable/Satellite (Analogique/Antenne/Câble/Satellite) : appuyez sur les touches ▲/▼ pour sélectionner une option, puis appuyez sur la touche **OK** pour accéder au sous-menu.

Auto Channel Update (Mise à jour automatique des chaînes) : appuyez sur la touche **OK** pour choisir **ON/OFF (Marche/Arrêt)**. Si vous sélectionnez « ON » (Marche), le système recherche et met à jour automatiquement les chaînes au bout de 5 minutes de veille.

Channel Update Message (Message de mise à jour des chaînes) : appuyez sur la touche **OK** pour choisir **ON/OFF (Marche/Arrêt)**. Si vous sélectionnez « ON » (Marche), le système recherche affiche un message de mise à jour.

Remarque : la source disponible peut varier selon le modèle.

ENTRÉES

Menu->Settings->Channels & Inputs->Inputs (Menu -> Paramètres -> Chaînes et entrées -> Entrées)

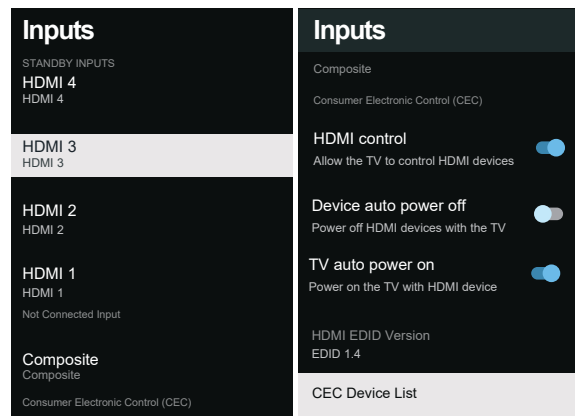

MODE D'EMPLOI

Inputs (Entrées) : appuyez sur les touches ▲/▼ pour sélectionner une option, puis appuyez sur la touche **OK** pour accéder au sous-menu.

HDMI control (Contrôle HDMI) : appuyez sur les touches ▲/▼ pour sélectionner une option, puis appuyez sur la touche **OK** pour choisir ON (Marche) ou OFF (Arrêt).

Device auto power off (Arrêt automatique du dispositif) : appuyez sur les touches ▲/▼ pour sélectionner une option, puis appuyez sur la touche **OK** pour choisir ON (Marche) ou OFF (Arrêt).

TV auto power on (Activer au démarrage du téléviseur) : appuyez sur les touches ▲/▼ pour sélectionner une option, puis appuyez sur la touche **OK** pour choisir ON (Marche) ou OFF (Arrêt).

HDMI EDID Version (Version EDID HDMI) : affiche la version EDID.

CEC Device List (Liste des dispositifs CEC) : appuyez sur les touches ▲/▼ pour sélectionner une option, puis appuyez sur la touche **OK** pour accéder au sous-menu.

IMAGE ET SON

Menu->Settings-> Display & Sound (Menu -> Paramètres -> Image et son)

À partir de ce menu, réglez l'image, le son et la sortie audio du téléviseur.

1. Appuyez sur les touches ▲/▼ pour sélectionner l'option que vous désirez régler.
2. Appuyez sur la touche **OK** pour confirmer.
3. Une fois le réglage terminé, appuyez sur la touche de retour pour revenir au menu précédent.

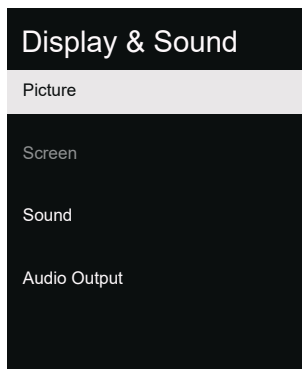

IMAGE

Menu->Settings->Display & Sound-> Picture (Menu -> Paramètres -> Affichage et son -> Image).

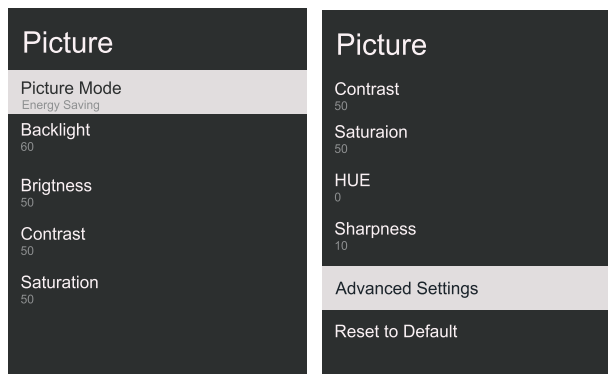

Picture Mode (Mode image) : appuyez sur les touches ▲/▼ pour sélectionner une option, puis appuyez sur la touche **OK** pour accéder au sous-menu. (Option : Utilisateur, Standard, Dynamique, Sport, Film, Jeu, Économie d'énergie)

Backlight/Brightness/Contrast/Saturation/HUE/Sharpness (Rétroéclairage/Luminosité/Contraste/Saturation/Teinte/Netteté) : appuyez sur les touches ▲/▼ pour sélectionner une option, puis appuyez sur la touche **OK** pour confirmer.

Appuyez sur la touche ◀ pour diminuer la valeur. Appuyez sur la touche ▶ pour augmenter la valeur.

Advanced Settings (Paramètres avancés) : appuyez sur les touches ▲/▼ pour sélectionner une option, appuyez sur la touche **OK** pour accéder au sous-menu.

Reset to Default (Réglages par défaut) : restaurez tous les paramètres aux réglages d'usine par défaut.

SON

Menu->Settings-> Display & Sound->Sound (Menu -> Paramètres -> Image et son -> Son).

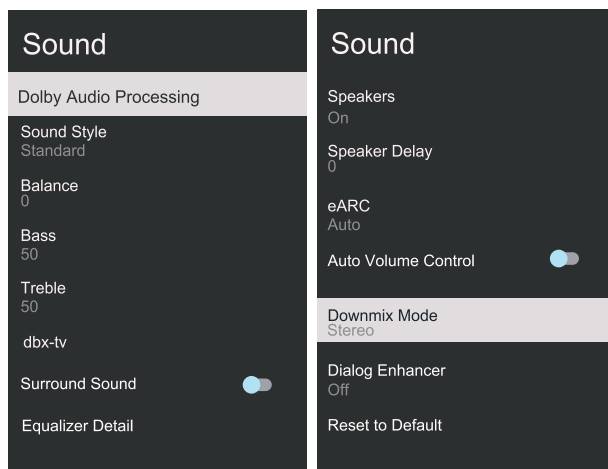

Dolby Audio processing (Traitement Dolby Audio) : appuyez sur les touches ▲/▼ pour sélectionner une option, appuyez sur la touche **OK** pour accéder au sous-menu.

Sound style (Style de son) : appuyez sur les touches ▲/▼ pour sélectionner une option, appuyez sur la

MODE D'EMPLOI

touche **OK** pour accéder au sous-menu.

(Option : Utilisateur, Standard, Nuit, Sport, Film, Musique, Actualités)

Balance/Bass/Treble (Balance/Basses/Aigus) : appuyez sur les touches ▲/▼ pour sélectionner une option, puis appuyez sur la touche **OK** pour confirmer.

Appuyez sur la touche ◀ pour diminuer la valeur.

Appuyez sur la touche ▶ pour augmenter la valeur.

dbx-tv : appuyez sur les touches ▲/▼ pour sélectionner une option, puis appuyez sur la touche **OK** pour accéder au sous-menu.

Surround Sound (Son d'ambiance) : appuyez sur les touches ▲/▼ pour sélectionner une option, puis appuyez sur la touche **OK** pour choisir ON (Marche) ou OFF (Arrêt).

Equalizer Detail (Égaliseur) : appuyez sur les touches ▲/▼ pour sélectionner une option, appuyez sur la touche **OK** pour accéder au sous-menu.

Speakers (Haut-parleurs) : appuyez sur les touches ▲/▼ pour sélectionner une option, puis appuyez sur la touche **OK** pour choisir ON (Marche) ou (Arrêt).

Speaker Delay (Délai Haut-parleur) : appuyez sur les touches ▲/▼ pour sélectionner une option, puis appuyez sur la touche **OK** pour confirmer.

Appuyez sur la touche ◀ pour diminuer la valeur.

Appuyez sur la touche ▶ pour augmenter la valeur.

eARC : appuyez sur les touches ▲/▼ pour sélectionner une option, puis appuyez sur la touche **OK** pour choisir Auto (Automatique) ou OFF (Arrêt).

Auto Volume Control (Contrôle de volume automatique) : appuyez sur les touches ▲/▼ pour sélectionner une option, puis appuyez sur la touche **OK** pour choisir ON (Marche) ou OFF (Arrêt).

Downmix Mode (Mode sous-mixage) : appuyez sur les touches ▲/▼ pour sélectionner une option, appuyez sur la touche **OK** pour accéder au sous-menu.

(Option : Stéréo, Surround)

Dialog Enhancer (Amélioration des dialogues) : appuyez sur les touches ▲/▼ pour sélectionner une option, appuyez sur la touche **OK** pour accéder au sous-menu.

(Option : Arrêt, Faible, Moyen et Élevé)

Reset to Default (Réglages par défaut) : restaurez tous les paramètres aux réglages d'usine par défaut.

SORTIE AUDIO

Menu->Settings->Display & Sound-> Audio Output (Menu -> Paramètres -> Affichage et son -> Sortie audio).

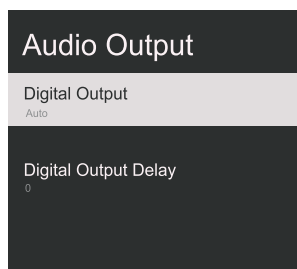

Digital Output (Sortie numérique) : appuyez sur les touches ▲/▼ pour sélectionner une option, appuyez sur la touche **OK** pour accéder au sous-menu.

(Option : Automatique, Pont, PCM, Dolby Digital Plus et Dolby Audio-Dolby Digital)

Digital Output Delay (Délai de sortie numérique) : appuyez sur les touches ▲/▼ pour sélectionner une option, puis appuyez sur la touche **OK** pour confirmer.

Appuyez sur la touche ◀ pour diminuer la valeur.

Appuyez sur la touche ▶ pour augmenter la valeur.

RÉSEAU

Menu->Settings->Network & Internet (Menu -> Paramètres -> Réseau et Internet)

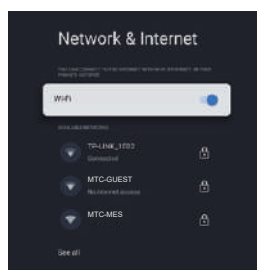

1. Appuyez sur les touches ▲/▼ pour sélectionner l'option que vous désirez régler.
2. Appuyez sur la touche **OK** pour confirmer.
3. Une fois le réglage terminé, appuyez sur la touche **OK** pour enregistrer et revenir au menu précédent.

COMPTE ET CONNEXION

1. Menu->Settings->Accounts & sign-in (Menu -> Paramètre -> Comptes et connexion).
2. À partir de la page d'accueil, appuyez sur les touches ▲/▼ pour sélectionner « Set up Google TV » (Configuration de Google TV), puis passez à l'étape suivante.

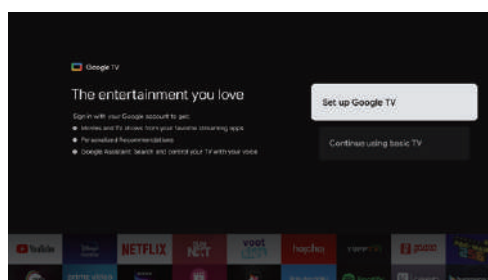

Sélectionnez « Set up Google TV » (Configuration de Google TV), puis passez à l'étape suivante, saisissez

MODE D'EMPLOI

vosre compte et mot de passe.
Suivez ensuite les instructions pour régler les paramètres pertinents.

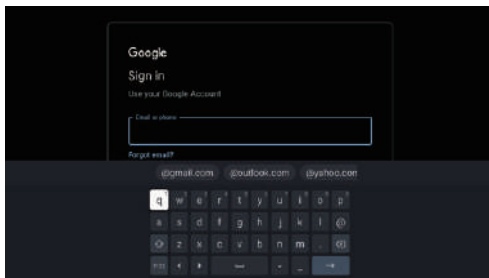

CONFIDENTIALITÉ

Menu->Settings->Privacy (Menu -> Paramètres -> Confidentialité).

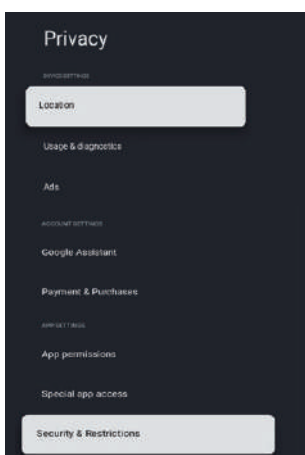

À partir de ce menu, réglez la localisation, l'utilisation et les diagnostics, etc., du téléviseur.

1. Appuyez sur les touches ▲/▼ pour sélectionner l'option que vous désirez régler.
2. Appuyez sur la touche OK pour confirmer.
3. Une fois le réglage terminé, appuyez sur la touche de retour pour revenir au menu précédent.

LOCALISATION

Menu->Settings->Privacy ->Location (Menu -> Paramètres -> Confidentialité -> Localisation).

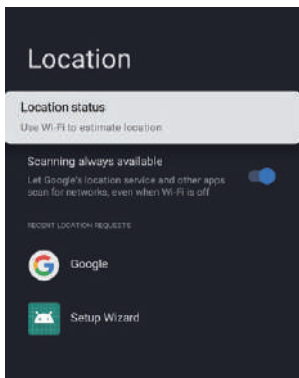

Location status (État de la localisation) : appuyez sur les touches ▲/▼ pour sélectionner une option, puis appuyez sur la touche OK pour accéder au sous-menu.

(Option : Utiliser le Wi-Fi pour la localisation, Arrêt)

Scanning always available (Détection toujours disponible) : appuyez sur les touches ▲/▼ pour sélectionner une option, puis appuyez sur la touche OK pour choisir ON (Marche) ou OFF (Arrêt).

UTILISATION ET DIAGNOSTICS

Menu->Settings->Privacy ->Usage & diagnostics (Menu -> Paramètres -> Confidentialité -> Utilisation et diagnostics)

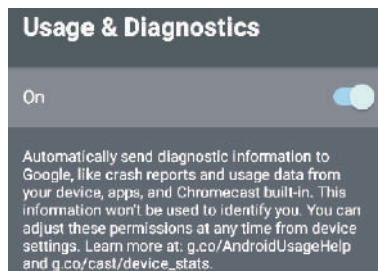

Usage & diagnostics (Utilisation et diagnostics) : appuyez sur les touches ▲/▼ pour sélectionner une option, puis appuyez sur la touche OK pour choisir ON (Marche) ou OFF (Arrêt).

APPLICATIONS

Menu->Settings->Apps (Menu -> Paramètres -> Applications).

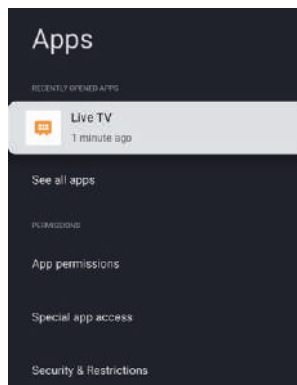

À partir de ce menu, définissez les autorisations des applications et consultez la liste des applications.

1. Appuyez sur les touches ▲/▼ pour sélectionner l'option que vous désirez régler.
2. Appuyez sur la touche OK pour confirmer.
3. Une fois le réglage terminé, appuyez sur la touche de retour pour revenir au menu précédent.

SYSTÈME

Menu->Settings->System (Menu -> Paramètres -> Système).

MODE D'EMPLOI

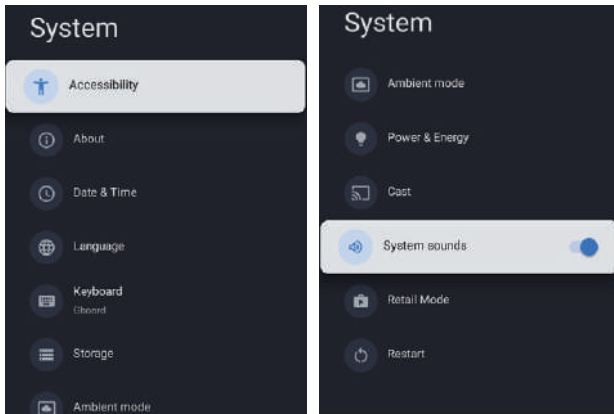

À partir de ce menu, consultez les informations et les paramètres du téléviseur.

1. Appuyez sur les touches ▲/▼ pour sélectionner l'option que vous désirez régler.
2. Appuyez sur la touche OK pour confirmer.
3. Une fois le réglage terminé, appuyez sur la touche de retour pour revenir au menu précédent.

Sons du système : appuyez sur les touches ▲/▼ pour sélectionner une option, puis appuyez sur la touche OK pour choisir ON (Marche) ou OFF (Arrêt). Pour plus de détails sur le système, reportez-vous à leur explication ci-après.

ACCESSIBILITÉ

Menu->Settings->System -> Accessibility (Menu -> Paramètres -> Système-> Accessibilité).

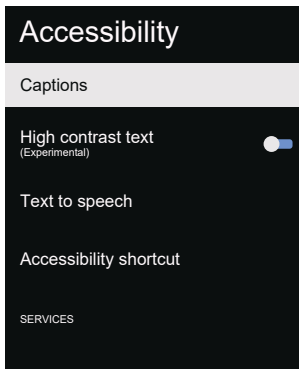

Captions (Sous-titres) : appuyez sur les touches ▲/▼ pour sélectionner une option, puis appuyez sur la touche OK pour accéder au sous-menu.

High contrast text (Texte en contraste élevé) : appuyez sur les touches ▲/▼ pour sélectionner une option, puis appuyez sur la touche OK pour choisir ON (Marche) ou OFF (Arrêt).

Text to speech (Synthèse vocale) : appuyez sur les touches ▲/▼ pour sélectionner une option, puis appuyez sur la touche OK pour accéder au sous-menu.

Accessibility shortcut (Raccourci d'accessibilité) : appuyez sur les touches ▲/▼ pour sélectionner une option, appuyez sur la touche OK pour accéder au sous-menu.

À PROPOS

Menu->Settings->System ->About (Menu -> Paramètres -> Système -> À propos).

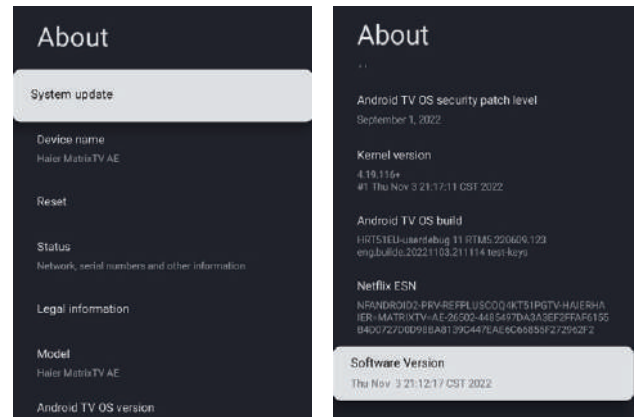

À partir de ce menu, effectuez la mise à jour du système, réinitialisez ou consultez les informations du téléviseur.

1. Appuyez sur les touches ▲/▼ pour sélectionner l'option que vous désirez régler.
2. Appuyez sur la touche OK pour confirmer.
3. Une fois le réglage terminé, appuyez sur la touche de retour pour revenir au menu précédent.

DATE ET HEURE

Menu->Settings->System -> Date & Time (Menu -> Paramètres -> Système -> Date et heure).

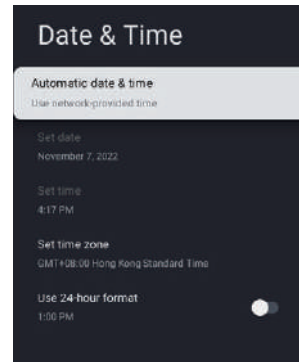

Automatic date & time (Date et heure automatique) : appuyez sur les touches ▲/▼ pour sélectionner une option, puis appuyez sur la touche OK pour accéder au sous-menu.

(Option : Utiliser l'heure du réseau, Arrêt)

REMARQUE :

- Si la fonction de réglage automatique de la date et de l'heure est désactivée, vous pouvez utiliser le réglage manuel de la date et de l'heure.

Set date (Régler la date) : appuyez sur les touches ▲/▼ pour sélectionner une option, puis appuyez sur la touche OK pour accéder au sous-menu.

Set time (Régler l'heure) : appuyez sur les touches ▲/▼ pour sélectionner une option, puis appuyez sur la touche OK pour accéder au sous-menu.

Set time zone (Régler le fuseau horaire) : appuyez sur les touches ▲/▼ pour sélectionner une option,

MODE D'EMPLOI

puis appuyez sur la touche **OK** pour accéder au sous-menu.

Use 24-hour format (Utiliser le format 24 heures) : appuyez sur les touches ▲/▼ pour sélectionner une option, puis appuyez sur la touche **OK** pour choisir ON (Marche) ou OFF (Arrêt).

LANGUE

Menu->Settings->System-> Language (Menu -> Paramètres -> Système -> Langue).

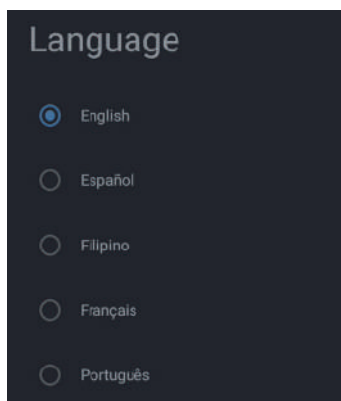

Language (Langue) : appuyez sur les touches ▲/▼ pour sélectionner une option, puis appuyez sur la touche **OK** pour accéder à la sélection de la langue.

CLAVIER

Menu->Settings->System-> Keyboard (Menu -> Paramètres -> Système -> Clavier).

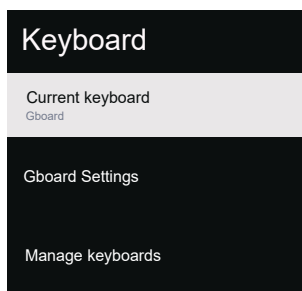

Current keyboard (Clavier actuel) : appuyez sur les touches ▲/▼ pour sélectionner une option, puis appuyez sur la touche **OK** pour accéder au sous-menu.

Gboard Settings (Paramètres Gboard) : appuyez sur les touches ▲/▼ pour sélectionner une option, appuyez sur la touche **OK** pour accéder au sous-menu.

Manage keyboards (Gestion des claviers) : appuyez sur les touches ▲/▼ pour sélectionner une option, puis appuyez sur la touche **OK** pour accéder au sous-menu.

STOCKAGE

Menu->Settings-> System->Storage (Menu -> Paramètres -> Système -> Stockage).

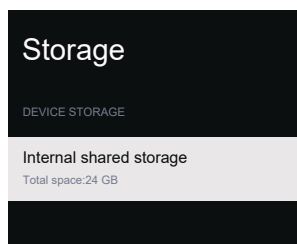

Internal shared storage (Stockage interne partagé) : appuyez sur les touches ▲/▼ pour sélectionner une option, puis appuyez sur la touche **OK** pour accéder au sous-menu.

MODE AMBIANT

Menu->Settings->System-> Ambient mode (Menu -> Paramètres -> Système -> Mode ambiant).

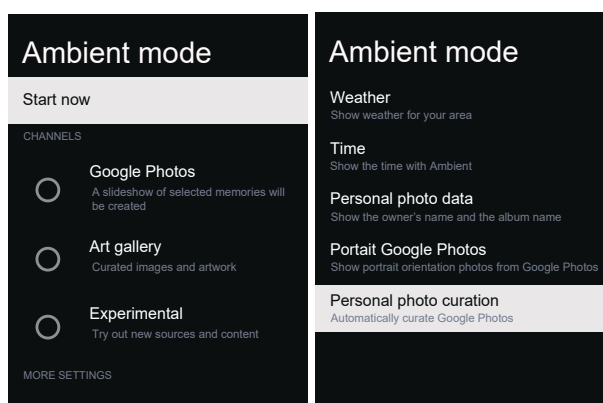

À partir de ce menu, réglez le mode ambiant.

1. Appuyez sur les touches ▲/▼ pour sélectionner l'option que vous désirez régler.
2. Appuyez sur la touche **OK** pour confirmer.
3. Une fois le réglage terminé, appuyez sur la touche de retour pour revenir au menu précédent.

ALIMENTATION ET ÉNERGIE

Menu->Settings-> System->Power & Energy (Menu -> Paramètres -> Système -> Alimentation et énergie).

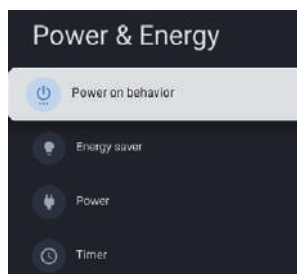

À partir de ce menu, réglez le mode d'alimentation et d'énergie.

(Option : Comportement au démarrage, économie d'énergie, alimentation et programmateur)

1. Appuyez sur les touches ▲/▼ pour sélectionner l'option que vous désirez régler.
2. Appuyez sur la touche **OK** pour confirmer.
3. Une fois le réglage terminé, appuyez sur la touche de retour pour revenir au menu précédent.

MODE D'EMPLOI

COMPORTEMENT AU DÉMARRAGE

Menu->Settings->System->Power & Energy->Power on behavior (Menu -> Paramètres -> Système -> Alimentation et énergie -> Comportement au démarrage).

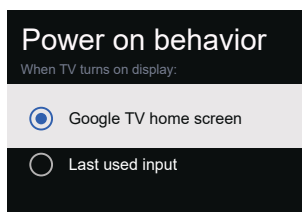

Appuyez sur les touches ▲/▼ pour sélectionner une option, puis appuyez sur la touche OK pour confirmer.

ÉCONOMIE D'ÉNERGIE

Menu->Settings->System-> Power & Energy ->Energy saver (Menu -> Paramètres -> Système -> Alimentation et énergie -> Économie d'énergie).

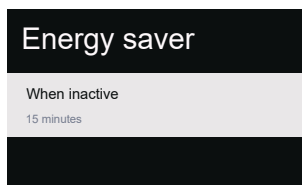

When inactive (En cas d'inactivité) : appuyez sur les touches ▲/▼ pour sélectionner une option, puis appuyez sur la touche OK pour accéder au sous-menu.

(Option : 15 minutes, 20 minutes, 30 minutes, 1 heure, 4 heures, 8 heures, 12 heures, 24 heures, Jamais).

ALIMENTATION

Menu->Settings->System-> Power & Energy->Power (Menu -> Paramètres -> Système -> Alimentation et énergie -> Alimentation).

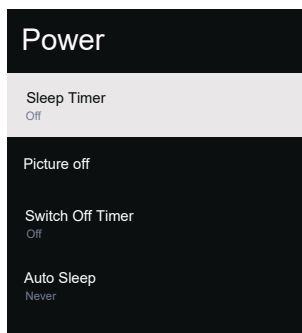

Sleep Timer (Délai avant veille) : appuyez sur les touches ▲/▼ pour sélectionner une option, puis appuyez sur la touche OK pour accéder au sous-menu.

(Option : Arrêt, 10 minutes, 20 minutes, 30 minutes, 40 minutes, 50 minutes, 60 minutes, 90 minutes, 120 minutes)

Picture off (Image d'arrêt) : Appuyez sur les touches ▲/▼ pour sélectionner une option, puis appuyez sur

la touche OK pour confirmer.

Switch off timer (Délai avant arrêt) : appuyez sur les touches ▲/▼ pour sélectionner une option, puis appuyez sur la touche OK pour accéder au sous-menu.

(Option : Arrêt, 30 minutes, 60 minutes, 90 minutes, 120 minutes, 150 minutes, 180 minutes, 210 minutes, 240 minutes)

Auto Sleep (Veille automatique) : appuyez sur les touches ▲/▼ pour sélectionner une option, puis appuyez sur la touche OK pour accéder au sous-menu.

(Option : Jamais, 4 heures, 6 heures, 8 heures)

PROGRAMMATEUR

Menu->Settings-> System-> Power & Energy->Timer (Menu -> Paramètres -> Système -> Alimentation et énergie -> Programmeur).

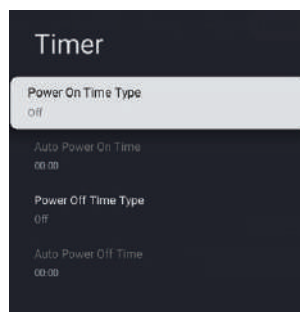

Power On Time Type (Type de mise en marche) : appuyez sur les touches ▲/▼ pour sélectionner une option, puis appuyez sur la touche OK pour choisir ON (Marche), OFF (Arrêt) ou ONCE (Une fois).

Auto Power On Time (Heure de mise en marche automatique) : appuyez sur les touches ▲/▼ pour sélectionner une option, puis appuyez sur la touche OK pour accéder au sous-menu.

Power Off Time Type (Type d'arrêt) : appuyez sur les touches ▲/▼ pour sélectionner une option, puis appuyez sur la touche OK pour choisir ON (Marche), OFF (Arrêt) ou ONCE (Une fois).

Auto Power Off Time (Heure d'arrêt automatique) : appuyez sur les touches ▲/▼ pour sélectionner une option, puis appuyez sur la touche OK pour accéder au sous-menu.

DIFFUSION

Menu->Settings->System-> Cast (Menu -> Paramètres -> Système -> Diffusion).

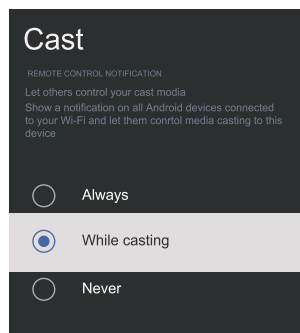

MODE D'EMPLOI

1. Appuyez sur les touches ▲/▼ pour sélectionner l'option que vous désirez régler.
2. Appuyez sur la touche **OK** pour confirmer.
3. Appuyez sur la touche de retour pour revenir au menu précédent.

MODE MAGASIN

Menu->Settings->System-> Retail Mode (Menu -> Paramètres -> Système -> Mode magasin).

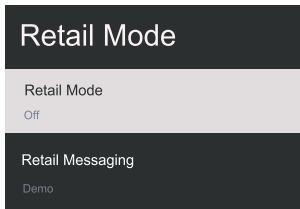

Retail mode (Mode magasin) : appuyez sur les touches ▲/▼ pour sélectionner une option, puis appuyez sur la touche **OK** pour choisir ON (Marche) ou OFF (Arrêt).

Retail messaging (Message du magasin) : appuyez sur les touches ▲/▼ pour sélectionner une option, puis appuyez sur la touche **OK** pour accéder au sous-menu. (Remarque : Démo, e-POP, e-POP + Démo)

REDÉMARRAGE

Menu->Settings->System-> Restart (Menu -> Paramètres -> Système -> Redémarrage).
Appuyez sur la touche **OK** pour accéder au sous-menu.
(Option : Redémarrer et Annuler)

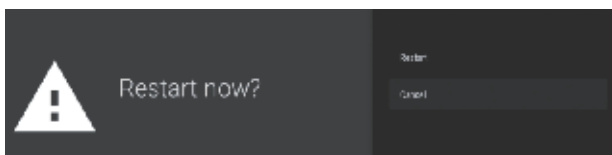

TÉLÉCOMMANDES ET ACCESSOIRES

Menu->Settings-> Remotes & Accessories. (Menu -> Paramètres -> Télécommandes et accessoires).

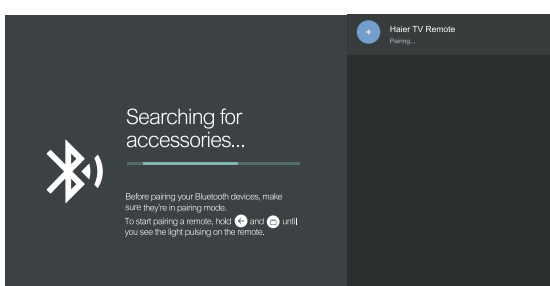
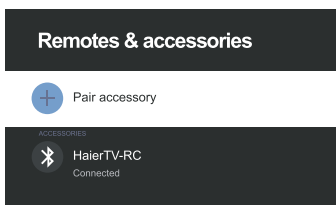

À partir de ce menu, effectuez le couplage des dispositifs Bluetooth.

1. Appuyez sur les touches « ← » et « ⏻ » au bas de la télécommande pendant 5 secondes.
2. Dès que le voyant se met à clignoter, relâchez-les. La télécommande émet le signal de couplage vers le téléviseur et les informations de la télécommande s'affichent sur le côté droit de l'écran.
3. Appuyez sur la touche **OK** pour afficher le résultat du couplage. Le couplage est réussi si un résultat est affiché.
4. Le couplage a échoué si rien ne s'affiche. Attendez 30 secondes, puis appuyez sur les touches « ← » et « ⏻ » au bas de la télécommande pendant 5 secondes pour répéter la procédure précédente.
5. Appuyez sur la touche « ← » pour revenir au menu précédent.

FONCTIONNEMENT DU LECTEUR MULTIMÉDIA

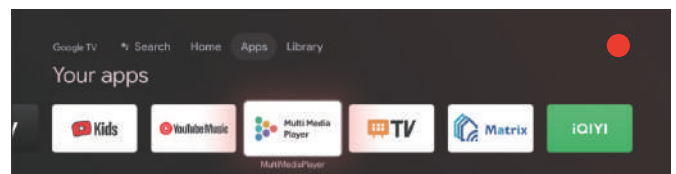

1. À partir de la page d'accueil ou de l'interface des **applications**, appuyez sur les touches ▲/▼/◀/▶ pour sélectionner l'application du lecteur multimédia.

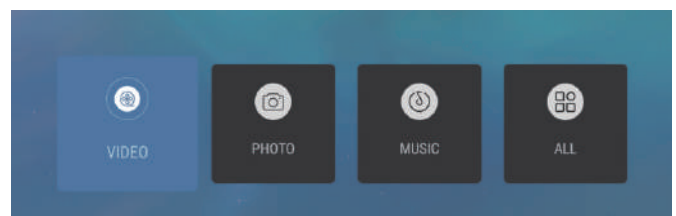

2. Sélectionner la touche **OK** pour accéder au lecteur multimédia et afficher les catégories Vidéo, Photo et Audio. Après avoir inséré une clé USB (au format FAT32), ses fichiers sont affichés.

REMARQUE :

Le menu peut se présenter de manière différente selon le pays d'achat du téléviseur.

DÉPANNAGE

Veillez procéder à ces opérations de vérification simples avant d'appeler le service après-vente. Ces conseils peuvent vous faire gagner du temps et de l'argent, car les frais d'installation du récepteur et de réglage des commandes du client ne sont pas couverts par la garantie.

Symptômes	Éléments à vérifier et mesures à prendre
Image « fantôme » ou double	<ul style="list-style-type: none">Ce problème peut être dû à l'obstruction de l'antenne par de hauts bâtiments ou collines. L'utilisation d'une antenne directionnelle peut améliorer l'image.
Aucune alimentation	<ul style="list-style-type: none">Vérifiez que le cordon d'alimentation secteur du téléviseur est branché dans la prise.Débranchez le téléviseur et attendez 60 secondes. Réinsérez ensuite la fiche dans la prise électrique, puis rallumez le téléviseur.
Aucune image	<ul style="list-style-type: none">Vérifiez les branchements de l'antenne situés à l'arrière du téléviseur pour vous assurer qu'elle est correctement connectée au téléviseur.Problème possible de la station de radiodiffusion. Essayez une autre chaîne.Réglez les paramètres de contraste et de luminosité.Vérifiez le réglage des sous-titres codés. Certains modes TEXTE peuvent bloquer l'écran.
Bonne image mais aucun son	<ul style="list-style-type: none">Appuyez sur la touche MUTE de la télécommande pour vous assurer que le son n'est pas désactivé.
Bon son mais couleur médiocre	<ul style="list-style-type: none">Réglez les paramètres de contraste, de couleur et de luminosité.
Image de mauvaise qualité	<ul style="list-style-type: none">Une mauvaise qualité d'image peut se produire lorsqu'une caméra ou un caméscope S-VHS est allumé et connecté à votre téléviseur et à d'autres dispositifs en même temps. Éteignez l'un des autres dispositifs.
Image et bruit de neige	<ul style="list-style-type: none">Vérifier la connexion de l'antenne.
Ligne horizontale en pointillés	<ul style="list-style-type: none">Ce problème peut être causé par des interférences électriques (par exemple, un sèche-cheveux, des néons à proximité, etc.). Éteignez l'équipement correspondant.
Le téléviseur ne répond pas à la télécommande.	<ul style="list-style-type: none">Vérifier si les piles ne sont pas épuisées. Remplacez-les si nécessaire.Nettoyez la lentille du capteur de la télécommande sur le téléviseur.
Pixels (points) toujours sombres ou toujours allumés	<ul style="list-style-type: none">Votre téléviseur est un produit fabriqué avec précision à l'aide d'une technologie de pointe. Toutefois, il arrive que les pixels ne s'affichent pas correctement. Ces anomalies sont inévitables pour ce type de produit et ne représentent pas le signe d'un produit défectueux.

REMARQUE :

- Ce produit est équipé d'un panneau composé de sous-pixels dont la fabrication nécessite une technologie sophistiquée. Néanmoins, quelques pixels clairs ou foncés peuvent apparaître à l'écran. Ces pixels n'ont aucune répercussion sur les performances du produit.



Les termes HDMI, HDMI High-Definition Multimedia Interface, HDMI Trade Dress et le logo HDMI sont des marques commerciales ou des marques déposées de HDMI Licensing Administrator, Inc.



Dolby, Dolby Vision, Dolby Atmos, Dolby Audio et le symbole du double D sont des marques de commerce de Dolby Laboratories Licensing Corporation. Fabriqué avec l'autorisation de Dolby Laboratories. Travaux confidentiels non publiés. Copyright ©2012-2024 Dolby Laboratories. Tous droits réservés.

CARACTÉRISTIQUES DU PRODUIT

Téléviseur LED UHD 43"

Qualité de l'image de télévision :	UHD Numérique intégré. Taille de l'écran : 108 cm Résolution de 3 840 x 2 160 pixels à 60 Hz.
Système TV :	PAL-B/G, SECAM-B/G
Décodeur syntoniseur DTV	DVB-T, DVB-C, DVB-T2, DVB-S2 Modulation 16/32/64/128/256 QAM MPEG2, MPEG4, H.265
Connectivité :	1 port optique 2 ports USB 1 port LAN 4 connecteurs HDMI 1 connecteur vidéo 1 connecteur gauche (L) 1 connecteur droit (R) 2 connecteurs RF 1 port pour casque d'écoute 1 fente pour carte CI Systèmes compatibles : PAL + SECAM Nombre de chaînes stockées : 1 000 (DTV), 100 (ATV) TV (RF) : 75 Ω asymétrique Entrée vidéo (AV) : 75 Ω, 1 V crête, RCA Entrée audio (AV) : 20 kΩ, 500 mV RMS Entrée vidéo (HDMI) : 480i, 480p, 720p, 1080i, 1080p, 2160p Wi-Fi : Norme : IEEE 802.11a/b/g/n/ac. Fréquence : 2,4 GHz/5 GHz Bluetooth : v 5.1
Qualité du son :	système de son stéréo. Puissance de sortie 2 x 10 W RMS.
Consommation électrique en veille	≤ 0,5 W
Fonctions numériques :	Interactivité numérique. Texte numérique. Sous-titrage de télédiffusion vidéo numérique (DVB) disponible. Configuration automatique. Recherche automatique de nouvelles chaînes. Guide des programmes du jour et suivant. Guide électronique des programmes sur 7 jours (EPG). Fente pour carte CI. Compatible avec l'audiodescription.
Fonctions supplémentaires :	Syntoniseur UHF/VHF, programmateur de veille, contrôle parental, image et texte 2 piles AAA pour la télécommande. Dimensions du support VESA : 300 x 300 mm Dimensions de l'emballage (L x H x P) : 1 075 x 652 x 142 mm Dimensions du téléviseur (L x H x P) avec socle : 957,2 x 607,4 x 240,7 mm Dimensions du téléviseur (L x H x P) sans socle : 957,2 x 566,7 x 86,6 mm Poids emballé : 10 kg Poids du téléviseur avec socle : 7,2 kg Poids du téléviseur sans socle : 6,8 kg

* Les caractéristiques techniques de ce téléviseur sont données à titre indicatif.
Des différences peuvent apparaître au fur et à mesure que la technologie des produits évolue.
Le design et les spécifications sont susceptibles d'être modifiés sans préavis.

CARACTÉRISTIQUES DU PRODUIT

Téléviseur LED UHD 50"

Qualité de l'image de télévision :	UHD Numérique intégré. Taille de l'écran : 126 cm Résolution de 3 840 x 2 160 pixels à 60 Hz.
Système TV :	PAL-B/G, SECAM-B/G
Décodeur syntoniseur DTV	DVB-T, DVB-C, DVB-T2, DVB-S2 Modulation 16/32/64/128/256 QAM MPEG2, MPEG4, H.265
Connectivité :	1 port optique 2 ports USB 1 port LAN 4 connecteurs HDMI 1 connecteur vidéo 1 connecteur gauche (L) 1 connecteur droit (R) 2 connecteurs RF 1 port pour casque d'écoute 1 fente pour carte CI Systèmes compatibles : PAL + SECAM Nombre de chaînes stockées : 1 000 (DTV), 100 (ATV) TV (RF) : 75 Ω asymétrique Entrée vidéo (AV) : 75 Ω, 1 V crête, RCA Entrée audio (AV) : 20 kΩ, 500 mV RMS Entrée vidéo (HDMI) : 480i, 480p, 720p, 1080i, 1080p, 2160p Wi-Fi : Norme : IEEE 802.11 a/b/g/n/ac. Fréquence : 2,4 GHz/5 GHz Bluetooth : v 5.1
Qualité du son :	système de son stéréo. Puissance de sortie 2 x 13.5 W RMS.
Consommation électrique en veille	≤ 0,5 W
Fonctions numériques :	Interactivité numérique. Texte numérique. Sous-titrage de télédiffusion vidéo numérique (DVB) disponible. Configuration automatique. Recherche automatique de nouvelles chaînes. Guide des programmes du jour et suivant. Guide électronique des programmes sur 7 jours (EPG). Fente pour carte CI. Compatible avec l'audiodescription.
Fonctions supplémentaires :	Syntoniseur UHF/VHF, programmateur de veille, contrôle parental, image et texte 2 piles AAA pour la télécommande. Dimensions du support VESA : 300 x 300 mm Dimensions de l'emballage (L x H x P) : 1250 x 760 x 144 mm Dimensions du téléviseur (L x H x P) avec socle : 1111,2 x 710,5 x 277,2 mm Dimensions du téléviseur (L x H x P) sans socle : 1111,2 x 651,8 x 88 mm Poids emballé : 13,5 kg Poids du téléviseur avec socle : 10 kg Poids du téléviseur sans socle : 9,5 kg

* Les caractéristiques techniques de ce téléviseur sont données à titre indicatif.
Des différences peuvent apparaître au fur et à mesure que la technologie des produits évolue.
Le design et les spécifications sont susceptibles d'être modifiés sans préavis.

CARACTÉRISTIQUES DU PRODUIT

Téléviseur LED UHD 55"

Qualité de l'image de télévision :	UHD Numérique intégré. Taille de l'écran : 139 cm Résolution de 3 840 x 2 160 pixels à 60 Hz.
Système TV :	PAL-B/G, SECAM-B/G
Décodeur syntoniseur DTV	DVB-T, DVB-C, DVB-T2, DVB-S2 Modulation 16/32/64/128/256 QAM MPEG2, MPEG4, H.265
Connectivité :	1 port optique 2 ports USB 1 port LAN 4 connecteurs HDMI 1 connecteur vidéo 1 connecteur gauche (L) 1 connecteur droit (R) 2 connecteurs RF 1 port pour casque d'écoute 1 fente pour carte CI Systèmes compatibles : PAL + SECAM Nombre de chaînes stockées : 1 000 (DTV), 100 (ATV) TV (RF) : 75 Ω asymétrique Entrée vidéo (AV) : 75 Ω, 1 V crête, RCA Entrée audio (AV) : 20 kΩ, 500 mV RMS Entrée vidéo (HDMI) : 480i, 480p, 720p, 1080i, 1080p, 2160p Wi-Fi : Norme : IEEE 802.11a/b/g/n/ac. Fréquence : 2,4 GHz/5 GHz Bluetooth : v 5.1
Qualité du son :	système de son stéréo. Puissance de sortie 2 x 13,5 W RMS.
Consommation électrique en veille	≤ 0,5 W
Fonctions numériques :	Interactivité numérique. Texte numérique. Sous-titrage de télédiffusion vidéo numérique (DVB) disponible. Configuration automatique. Recherche automatique de nouvelles chaînes. Guide des programmes du jour et suivant. Guide électronique des programmes sur 7 jours (EPG). Fente pour carte CI. Compatible avec l'audiodescription.
Fonctions supplémentaires :	Syntoniseur UHF/VHF, programmateur de veille, contrôle parental, image et texte 2 piles AAA pour la télécommande. Dimensions du support VESA : 300 x 300 mm Dimensions de l'emballage (L x H x P) : 1 350 x 837 x 144 mm Dimensions du téléviseur (L x H x P) avec socle : 1 225,8 x 777,3 x 277,2 mm Dimensions du téléviseur (L x H x P) sans socle : 1 225,8 x 719,4 x 88,1 mm Poids emballé : 16,4 kg Poids du téléviseur avec socle : 11,9 kg Poids du téléviseur sans socle : 11,4 kg

* Les caractéristiques techniques de ce téléviseur sont données à titre indicatif.
Des différences peuvent apparaître au fur et à mesure que la technologie des produits évolue.
Le design et les spécifications sont susceptibles d'être modifiés sans préavis.

CARACTÉRISTIQUES DU PRODUIT

Téléviseur LED UHD 65"

Qualité de l'image de télévision :	UHD Numérique intégré. Taille de l'écran : 164 cm Résolution de 3 840 x 2 160 pixels à 60 Hz.
Système TV :	PAL-B/G, SECAM-B/G
Décodeur syntoniseur DTV	DVB-T, DVB-C, DVB-T2, DVB-S2 Modulation 16/32/64/128/256 QAM MPEG2, MPEG4, H.265
Connectivité :	1 port optique 2 ports USB 1 port LAN 4 connecteurs HDMI 1 connecteur vidéo 1 connecteur gauche (L) 1 connecteur droit (R) 2 connecteurs RF 1 port pour casque d'écoute 1 fente pour carte CI Systèmes compatibles : PAL + SECAM Nombre de chaînes stockées : 1 000 (DTV), 100 (ATV) TV (RF) : 75 Ω asymétrique Entrée vidéo (AV) : 75 Ω, 1 V crête, RCA Entrée audio (AV) : 20 kΩ, 500 mV RMS Entrée vidéo (HDMI) : 480i, 480p, 720p, 1080i, 1080p, 2160p Wi-Fi : Norme : IEEE 802.11 a/b/g/n/ac. Fréquence : 2,4 GHz/5 GHz Bluetooth : v 5.1
Qualité du son :	système de son stéréo. Puissance de sortie 2 x 13,5 W RMS.
Consommation électrique en veille	≤ 0,5 W
Fonctions numériques :	Interactivité numérique. Texte numérique. Sous-titrage de télédiffusion vidéo numérique (DVB) disponible. Configuration automatique. Recherche automatique de nouvelles chaînes. Guide des programmes du jour et suivant. Guide électronique des programmes sur 7 jours (EPG). Fente pour carte CI. Compatible avec l'audiodescription.
Fonctions supplémentaires :	Syntoniseur UHF/VHF, programmateur de veille, contrôle parental, image et texte 2 piles AAA pour la télécommande. Dimensions du support VESA : 400 x 300 mm Dimensions de l'emballage (L x H x P) : 1 600 x 960 x 164 mm Dimensions du téléviseur (L x H x P) avec socle : 1 446,4 x 904,7 x 313,8 mm Dimensions du téléviseur (L x H x P) sans socle : 1 446,4 x 841,3 x 85,1 mm Poids emballé : 24 kg Poids du téléviseur avec socle : 17,2 kg Poids du téléviseur sans socle : 16,5 kg

* Les caractéristiques techniques de ce téléviseur sont données à titre indicatif.
Des différences peuvent apparaître au fur et à mesure que la technologie des produits évolue.
Le design et les spécifications sont susceptibles d'être modifiés sans préavis.

Haier

Haier

Vivere ispirati

Manuale dell'utente

MODELLI:

H43Q80FUX

H50Q80FUX

H55Q80FUX

H65Q80FUX



Le illustrazioni contenute nella presente guida vengono fornite solo come riferimento e possono differire dall'aspetto reale del prodotto. Il design e le specifiche del prodotto possono essere modificati senza preavviso.

Televisore LED

TABELLA DEI CONTENUTI

1. ISTRUZIONI IMPORTANTI SULLA SICUREZZA.....	1
2. PREPARAZIONE.....	3
3. Collegamento delle periferiche e comandi.....	4
4. COLLEGAMENTI.....	5
5. ISTRUZIONI PER L'USO.....	6
6. RISOLUZIONE DEI PROBLEMI	19
7. SPECIFICHE DEL PRODOTTO	20



Le illustrazioni contenute nella presente guida vengono fornite solo come riferimento e possono differire dall'aspetto reale del prodotto.

Il design e le specifiche del prodotto possono essere modificati senza preavviso.

ISTRUZIONI IMPORTANTI SULLA SICUREZZA

- 1) Leggere queste istruzioni.
- 2) Conservare queste istruzioni.
- 3) Osservare tutte le avvertenze.
- 4) Seguire tutte le istruzioni.
- 5) Non utilizzare questo apparecchio vicino all'acqua.
- 6) Pulire solo con un panno asciutto.
- 7) Non bloccare le aperture di aerazione ed eseguire l'installazione secondo le istruzioni.
- 8) Non installare vicino a fonti di calore, come ad esempio radiatori, caloriferi, stufe o altri apparecchi (compresi gli amplificatori) che producono calore.
- 9) Non modificare in alcun modo la spina polarizzata per non compromettere la sicurezza. Se la spina fornita non è adatta alla propria presa, consultare un elettricista per la sostituzione della presa obsoleta.
- 10) Proteggere il cavo di alimentazione per evitare che venga calpestato o schiacciato, in particolare in corrispondenza delle spine, delle prese e del punto in cui fuoriesce dall'apparecchio.
- 11) Usare solo dispositivi opzionali/accessori specificati dal produttore.
- 12) Scollegare l'apparecchio in caso di temporali con fulmini o quando non viene utilizzato per lunghi periodi di tempo.
- 13) Per la manutenzione, consultare personale qualificato. La manutenzione è necessaria quando l'apparecchio è stato danneggiato in qualunque modo, ad esempio se il cavo di alimentazione o la spina sono danneggiati, se è stato versato del liquido o sono caduti oggetti all'interno dell'apparecchio, se l'apparecchio è stato esposto a pioggia o umidità, se non funziona normalmente o è caduto.
- 14) La spina di rete viene usata come dispositivo di scollegamento, pertanto dovrà essere sempre prontamente utilizzabile.
- 15) La ventilazione non deve essere impedita coprendo le aperture di aerazione con oggetti quali giornali, tovaglie, tende, ecc.
- 16) Non posizionare fiamme libere, come ad esempio candele accese, sull'apparecchio.
- 17) Fare attenzione agli aspetti ambientali in caso di smaltimento delle batterie.
- 18) Usare l'apparecchio in condizioni di clima moderato.
- 19) L'apparecchio non deve essere esposto a gocce o schizzi ed eventuali oggetti contenenti liquidi, come ad esempio vasi, non devono essere posizionati su di esso.
- 20) Avvertenza: Per evitare eventuali lesioni causate dal rovesciamento del prodotto, assicurarsi che sia posizionato orizzontalmente su una superficie piana.

L'aspetto reale del prodotto può variare rispetto all'immagine sopra riportata

Se come dispositivo di disconnessione si utilizza la spina del cavo di alimentazione, le istruzioni di installazione devono indicare che per tutte le apparecchiature collegabili la presa deve essere facilmente accessibile.



 Questo simbolo indica che all'interno di questa unità è presente una tensione pericolosa che comporta un rischio di scosse elettriche.

 Questo simbolo indica la documentazione che accompagna l'unità contiene importanti istruzioni per l'uso e la manutenzione.

AVVERTENZA:

Per ridurre il rischio di incendio o scosse elettriche, non esporre il dispositivo alla pioggia o all'umidità.

AVVERTENZA:

Le batterie non devono essere esposte a calore eccessivo, come la luce diretta del sole, il fuoco o altre fonti di calore simili.



Questo simbolo indica che il prodotto è dotato di un doppio isolamento tra la tensione di rete pericolosa e le parti accessibili all'utente. Durante la manutenzione utilizzare solo pezzi di ricambio identici.



Questo simbolo indica che il prodotto non deve essere smaltito con i normali rifiuti domestici. Per evitare possibili danni all'ambiente o alla salute dell'uomo derivanti dallo smaltimento incontrollato dei rifiuti, riciclare il prodotto responsabilmente per promuovere il riutilizzo sostenibile delle risorse materiali. Per restituire un dispositivo usato, utilizzare il sistema previsto per la restituzione e la raccolta, oppure contattare il rivenditore presso il quale il prodotto è stato acquistato. I rivenditori hanno i mezzi per ritirare questi prodotti e riciclarli in modo sicuro per l'ambiente.

ISTRUZIONI IMPORTANTI SULLA SICUREZZA

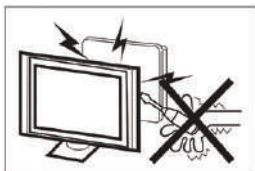

Il funzionamento del ricevitore del televisore richiede l'uso di alta tensione. Non rimuovere il pannello posteriore del mobile su cui è installato l'impianto. Per la manutenzione, rivolgersi a personale qualificato.

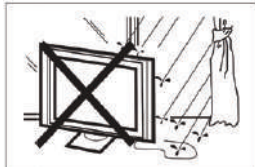

Per evitare il rischio di incendio o scosse elettriche, non esporre il ricevitore del televisore alla pioggia o all'umidità.



Non fare cadere o spingere oggetti nelle aperture presenti nella struttura esterna del televisore. Non versare liquidi sul ricevitore del televisore.



Non ostruire le aperture di aerazione presenti sul retro. La ventilazione è essenziale per impedire il malfunzionamento dei componenti elettrici.



Fare attenzione che il cavo di alimentazione non rimanga incastrato sotto al ricevitore del televisore.



Per pulire il prodotto, scollegare il televisore, utilizzare un panno morbido senz'acqua né prodotti chimici.



Non salire, appoggiarsi o spingere improvvisamente il televisore o il suo supporto. Fare molta attenzione in caso di presenza di bambini. L'eventuale caduta può provocare gravi lesioni.

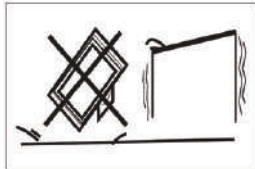

Non posizionare il televisore su un carrello, un supporto, una mensola o un tavolo instabile. L'eventuale caduta del televisore può causare gravi lesioni personali e danneggiare lo stesso televisore.



Se il ricevitore del televisore non viene utilizzato per un lungo periodo di tempo, si raccomanda di scollegare il cavo di alimentazione CA dalla presa CA.



Non esporre il ricevitore del televisore alla luce diretta del sole e ad altre fonti di calore. Non appoggiare il ricevitore del televisore direttamente su altri prodotti che possono trasmettere calore, come ad esempio video registratori e amplificatori audio. Non collocare sul televisore fiamme libere, come ad esempio candele accese.

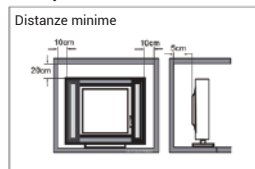

Se il televisore deve essere installato in un vano o in uno spazio simile, si raccomanda di rispettare le distanze minime. L'accumulo di calore può compromettere la vita utile del televisore e può essere pericoloso.

Nota: usare l'apparecchio in condizioni di clima moderato. Attenzione:

Il televisore potrebbe cadere, causando gravi lesioni o morte. Molti incidenti, soprattutto quelli che coinvolgono i bambini, possono essere evitati adottando semplici precauzioni, quali:

- Usare SEMPRE mobili, supporti o metodi di installazione raccomandati dal produttore del televisore.
- Usare SEMPRE mobili in grado di sostenere in modo sicuro il televisore.
- Accertarsi SEMPRE che il televisore non sporga dal bordo del mobile di supporto.
- Istruire SEMPRE i bambini sui pericoli che corrono arrampicandosi sul mobile per raggiungere il televisore o i comandi.
- Posizionare SEMPRE i cavi collegati al televisore in modo che non possano essere calpestati, tirati o afferrati.
- Non collocare MAI il televisore in una posizione non stabile.
- Non collocare MAI il televisore su mobili alti (ad esempio credenze o librerie) senza avere prima fissato in modo sicuro il mobile e il televisore ad un supporto adeguato.
- Non collocare MAI il televisore su un panno o un altro materiale posto tra il televisore stesso e il mobile di supporto.
- NON collocare MAI oggetti che potrebbero invogliare i bambini ad arrampicarsi, come ad esempio giocattoli e telecomandi, sul televisore o sul mobile su cui è installato il televisore.

Le suddette considerazioni sono applicabili anche al televisore attualmente in uso che viene spostato in un altro luogo della casa.

PREPARAZIONE

IMPORTANTE: Non esercitare pressione sull'area di visualizzazione dello schermo, poiché ciò potrebbe compromettere l'integrità dello schermo. La garanzia del produttore non copre gli usi inadeguati o le installazioni improprie dell'utente.

FISSAGGIO DEL SUPPORTO

IMPORTANTE: Il supporto del televisore deve essere assemblato prima dell'uso.

1. Posizionare il televisore con lo schermo rivolto verso il basso su una superficie morbida e piatta (coperta, gommapiuma, panno, ecc.) per evitare di danneggiare il televisore.
2. Fissare il supporto alla parte inferiore del televisore con le 6 viti fornite in dotazione.

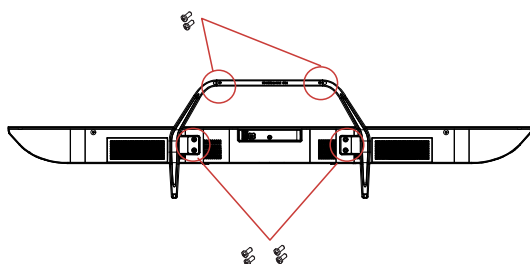

NOTE
Il prodotto deve essere visivamente in buone condizioni.

PREPARAZIONE DEL TELEVISORE LED PER L'INSTALLAZIONE A PARETE

Si consiglia di tenere il televisore ad una distanza di almeno 60 mm dalla parete, per evitare interferenze con i cavi. Prima di installare il televisore a parete, è necessario rimuovere il supporto.

Per garantire la vostra sicurezza, utilizzare solo una staffa di montaggio a parete omologata UL per il peso minimo del televisore senza supporto.

Per fissare una staffa di montaggio a parete al televisore procedere nel modo seguente:

1. Rimuovere le viti che fissano il televisore al supporto.
2. Rimuovere il supporto dal televisore.
3. Fissare la staffa di montaggio a parete sul retro del televisore usando quattro viti. Per l'installazione, seguire le istruzioni del manuale d'uso fornito con la staffa di montaggio a parete.

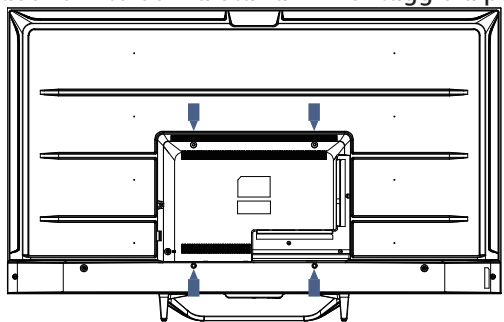

NOTE
La staffa di montaggio a parete non è inclusa.

4. Fissare le viti per il montaggio a parete (M6 x 12 mm/4 pezzi) sul lato posteriore del televisore LED, utilizzando una coppia di 12 kgf.cm.

ACCENSIONE DEL TELEVISORE

1. Installare il supporto e posizionare il televisore su una superficie stabile.

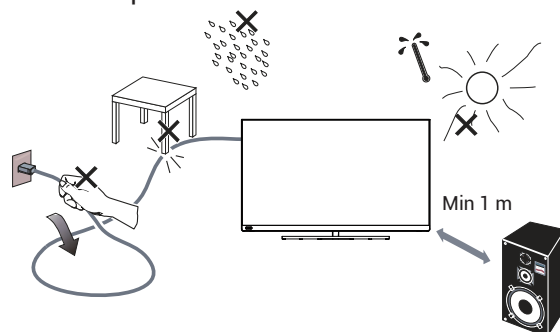

NOTE

- Assicurarsi che il televisore sia collocato in una posizione che consenta il libero flusso dell'aria. Non coprire le aperture di aerazione del coperchio posteriore.
 - Per evitare situazioni pericolose, non posizionare fiamme libere, come ad esempio candele accese, sull'apparecchio o nelle vicinanze.
 - Evitare l'esposizione al calore, alla luce solare diretta, alla pioggia o all'acqua. Evitare inoltre di esporre l'apparecchio a gocce o schizzi.
2. Collegare il cavo dell'antenna o il cavo del televisore alla presa dell'antenna **ANT IN** sul retro del televisore.
 3. Telecomando:
Rimuovere il coperchio del vano batterie. Inserire 2 batterie (1,5 V di tipo AAA).

ATTENZIONE: In caso di sostituzione della batteria con una batteria di tipo errato, vi è il rischio di esplosione.

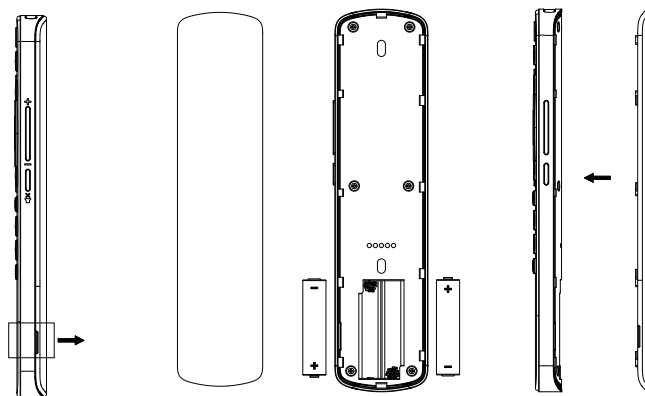

4. Alimentazione:
Collegare la spina a una presa di corrente funzionante.

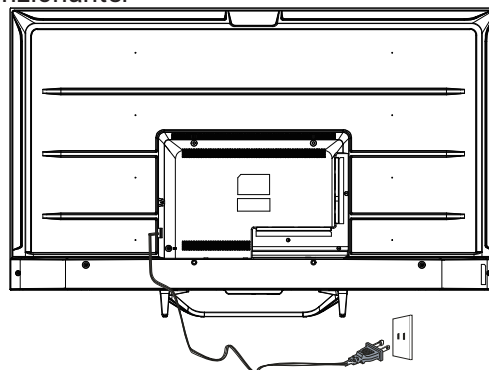

5. Accendere il televisore:
Premere  sul telecomando o il pulsante **ACCENSIONE** sul pannello di controllo laterale del televisore.

Collegamento delle periferiche e comandi

CONTROLLO TRAMITE I PULSANTI

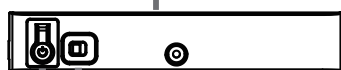
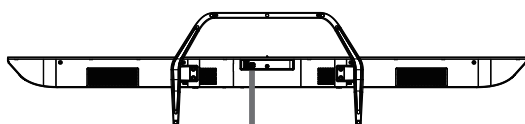
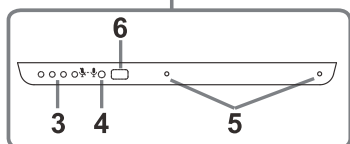
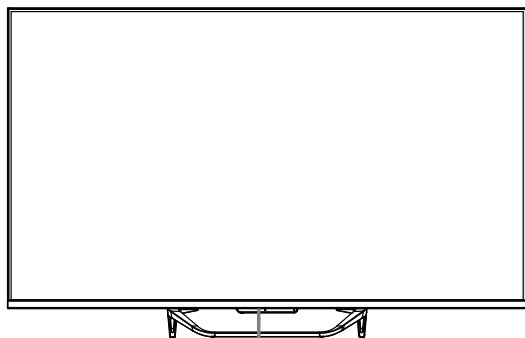

1. Accensione/spengimento
2. Funzione comando vocale attivata / disattivata
 - 🗣️ Abilitare l'assistente vocale a distanza
 - 🗣️ Disabilitare l'assistente vocale a distanza

Ruotare verso destra per attivare la funzione; la spia si accende e si spegne per indicare che la funzione di comando vocale è stata attivata. Per utilizzare la funzione di comando vocale, è possibile pronunciare "Ok Google"; l'indicatore si accende quando il televisore riceve il comando vocale e, a questo punto, è sufficiente pronunciare direttamente la richiesta.

Ruotare a sinistra per disattivare la funzione e uscire dall'impostazione; la spia diventa gialla.

3. Luce dell'assistente vocale a distanza
4. Ricevitore del segnale del telecomando
5. Ricevitore dei segnali vocali
6. LED di alimentazione

NOTE
Assicurarsi che il televisore sia collegato a Internet prima di utilizzare la funzione di comando vocale.
Attivare la funzione di comando vocale prima di utilizzarlo.
Accedere al proprio account GOOGLE prima di utilizzare la funzione di comando vocale.

ACCESSORI

- 1 telecomando
- 1 manuale d'uso
- 6 viti
- 1 guida introduttiva rapida
- 1 scheda di garanzia

CONNESSIONE DELLE PERIFERICHE



I terminali (da sinistra a destra) sono i seguenti:
LAN, OTTICO, VIDEO, S, D, HDMI4, HDMI3, HDMI2,



I terminali (da sinistra a destra) sono i seguenti:
HDMI1 (eARC/ARC), LNB IN (SATELLITE), ANT IN (ANTENNA/CAVO), USB1 , USB2, AURICOLARI, CI.

COLLEGAMENTI

APPARECCHIATURE AV

Questo televisore è dotato di un gruppo AV per un pratico collegamento a unità VCR, DVD o altre apparecchiature video.

Consultare il manuale d'uso dell'apparecchiatura da collegare.

I terminali di ingresso sul retro del televisore possono essere utilizzati come segue.

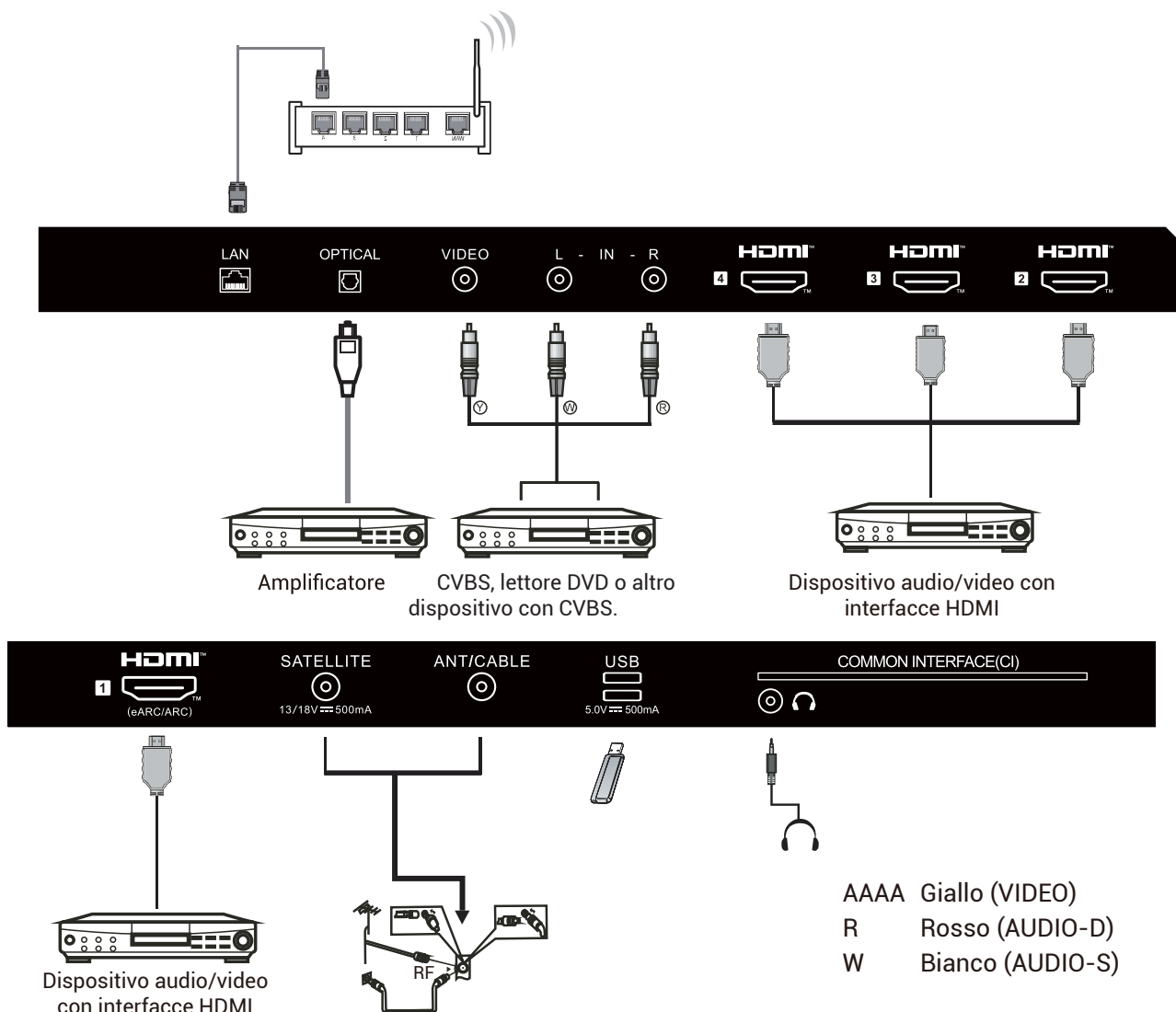

Il televisore può essere collegato ai seguenti dispositivi: VCR, lettore multidisco, DVD, videocamera, console per videogiochi o impianto stereo, ecc...

Nota:

A volte questa funzione non è supportata su alcuni dispositivi, perché questi forniscono un segnale non standard.

ISTRUZIONI PER L'USO

USO DEL TELECOMANDO

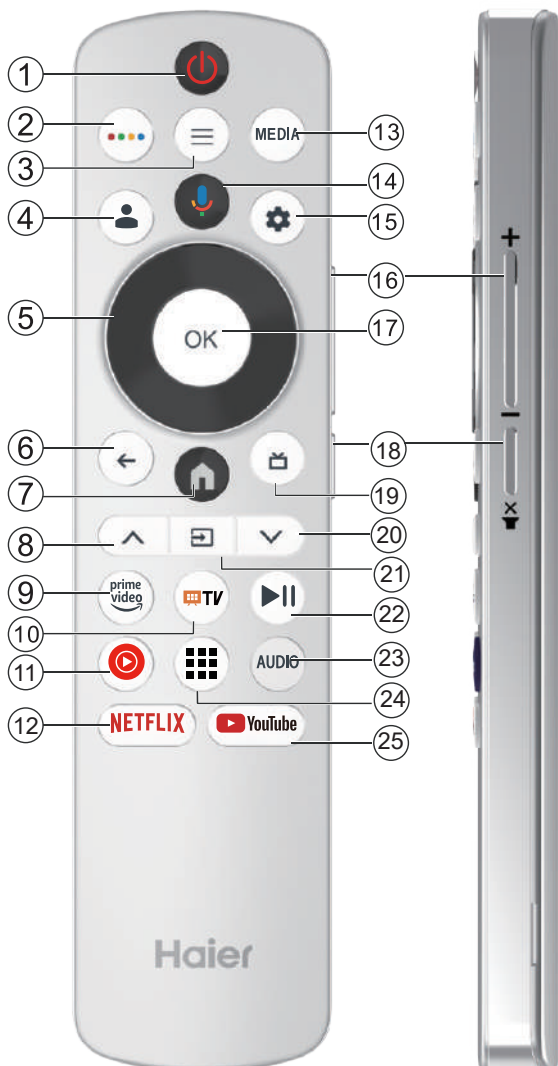

N.	Elemento	Descrizione
1	 Alimentazione	Per accendere o spegnere il televisore. Quando il televisore è spento, continua ad essere alimentato. Per interrompere completamente l'alimentazione, scollegare il cavo di alimentazione
2		Premere per aprire il PANNELLO DEI GIOCHI.
3		Premere per aprire o chiudere il menu sul display.
4		Premere per registrare il proprio account e accedere a Google TV. (Quando si impostano le funzioni di base della TV, questo tasto non ha alcun effetto)
5		Premere per navigare nel menu sul display.
6		Torna al menu precedente.
7		Premere per aprire la pagina home.
8		Premere per cambiare i canali TV.
9		Premere per attivare Prime Video e guardare programmi TV e film online (è necessaria una connessione a Internet).
10		Premere per accedere a Live TV.
11		Premere per accedere alla musica di YouTube.
12		Premere per accedere a Netflix.
13	MEDIA	Premere per accedere al lettore multimediale.
14		Premere per accedere all'assistente Google o avviare la ricerca vocale.
15		Premere per accedere al menu delle impostazioni.
16	VOL+ VOL-	Premere VOL+ o VOL- per regolare il livello del volume.
17	OK	Consente di accedere all'opzione selezionata o di eseguire l'operazione desiderata.
18		Premere per tacitare e riattivare l'audio.
19		Premere per visualizzare la guida elettronica ai programmi in modalità TV.
20		Premere per cambiare i canali TV.
21		Premere per accedere all'elenco delle sorgenti di ingresso.
22		Premere per riprodurre/mettere in pausa il contenuto in modalità multimediale.
23	AUDIO	Premere per cambiare traccia audio.
24		Premere per accedere alle applicazioni.
25		Premere per accedere a YouTube.

ISTRUZIONI PER L'USO

CONFIGURAZIONE INIZIALE

La prima volta che si accende il televisore, la procedura di configurazione guidata assiste l'utente nell'impostazione delle impostazioni di base. Attenersi alle istruzioni per eseguire correttamente la prima installazione.



Questa funzione viene utilizzata anche per l'ottenimento del codice di abbinamento del telecomando. Una volta ottenuto il codice, è possibile utilizzare il telecomando Bluetooth per controllare il televisore.

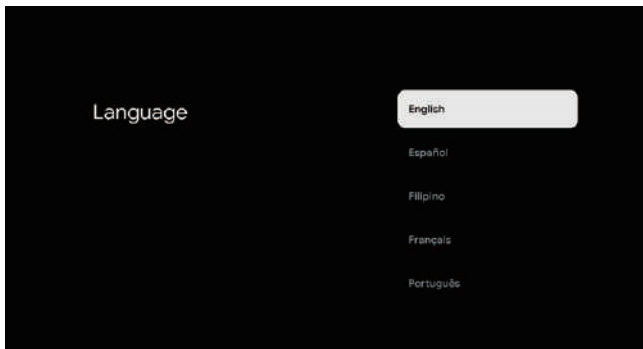

Premere ▲/▼ per selezionare la lingua, quindi premere OK per confermare.

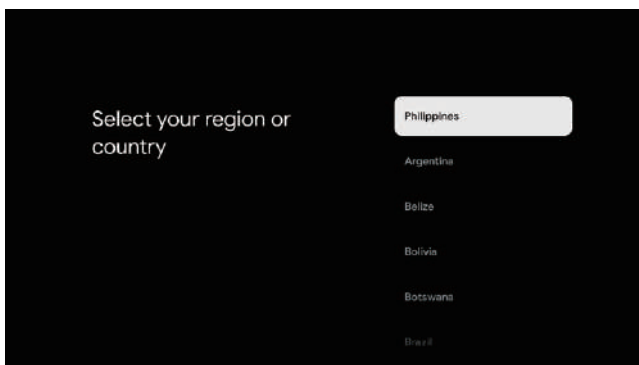

Premere ▲/▼ per selezionare il paese/la regione di utilizzo del dispositivo, quindi premere OK per confermare.

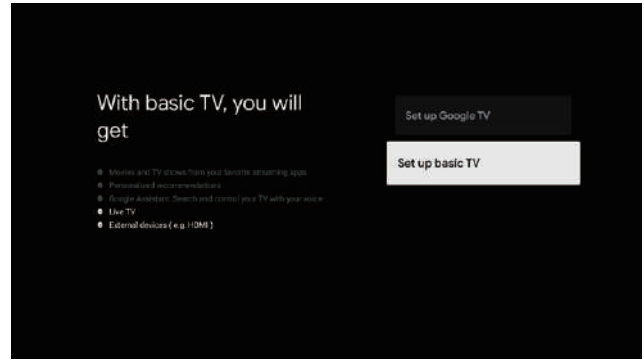

Premere ▲/▼ per selezionare "Set up basic TV" (Impostazione di base del televisore), quindi premere OK per completare l'impostazione.

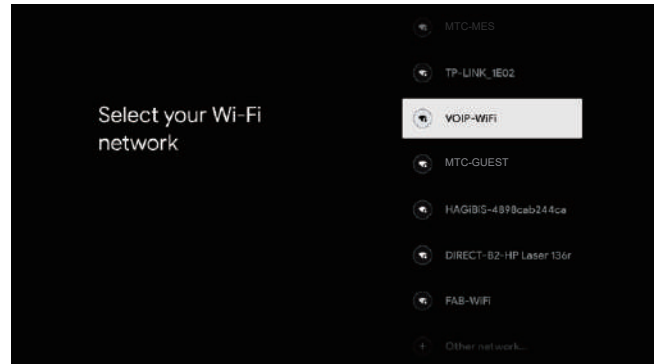

Premere ▲/▼ per selezionare la rete Wi-Fi alla quale collegarsi, quindi premere OK e immettere la password per confermare che la connessione è avvenuta con successo.

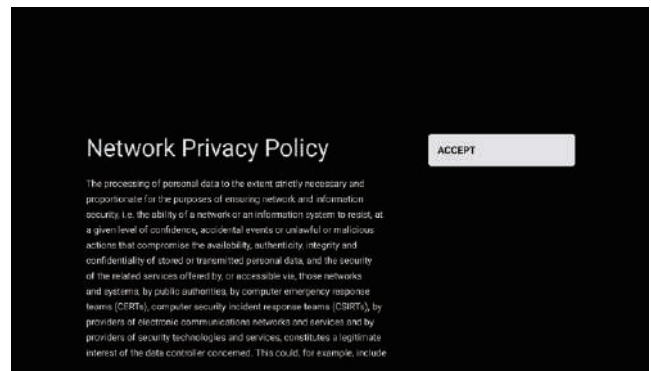

Selezionare "Accept" (Accetta) per accettare i termini dell'Informativa sulla Privacy della rete.

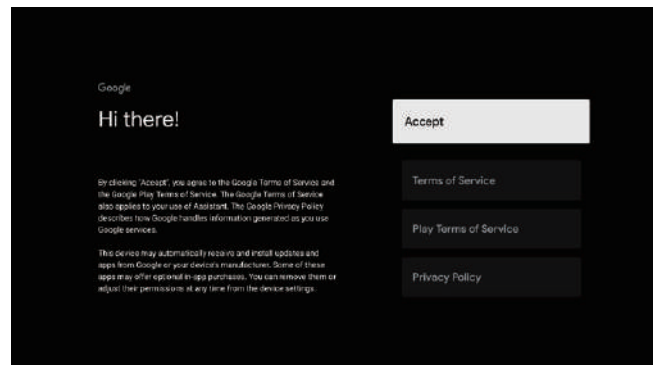

Selezionare "Accept" (Accetta) per accettare i Termini di Servizio di Google e migliorare l'esperienza del prodotto.

ISTRUZIONI PER L'USO

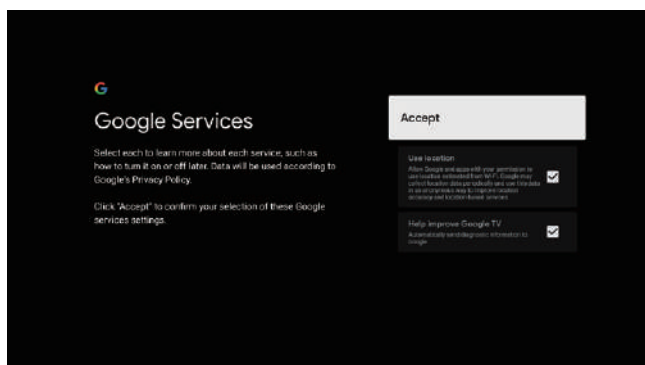

Selezionare "Accetta" (Accetta) per accettare i Servizi Google e migliorare l'esperienza del prodotto.

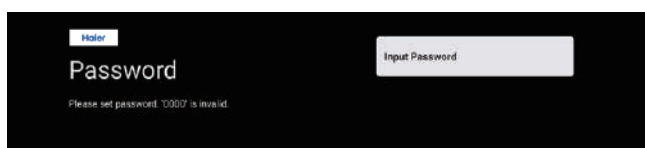

Ciò consente di impostare la password del dispositivo per garantire la sicurezza e il rispetto della privacy.

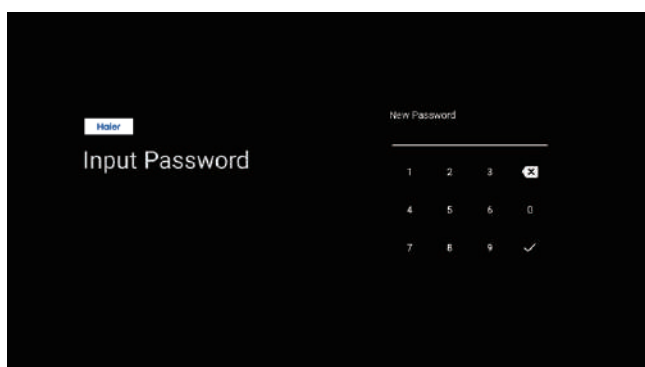

Utilizzare il telecomando/la tastiera su schermo per immettere la password a 4 cifre e passare automaticamente all'interfaccia successiva.

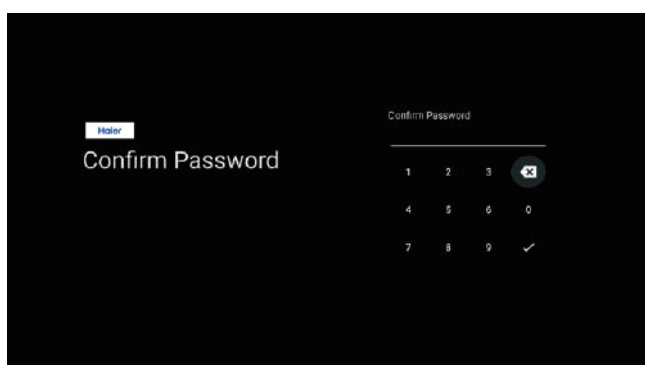

Confermare nuovamente la password e salvarla. Utilizzare il telecomando/la tastiera su schermo per immettere la password e completare l'operazione.

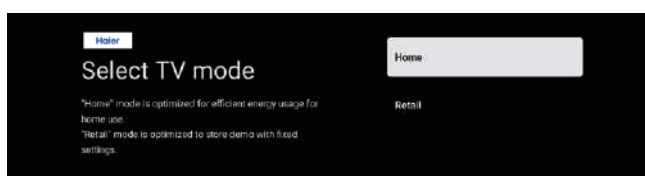

Premere ▲/▼ per selezionare la modalità Home, quindi premere OK per confermare.

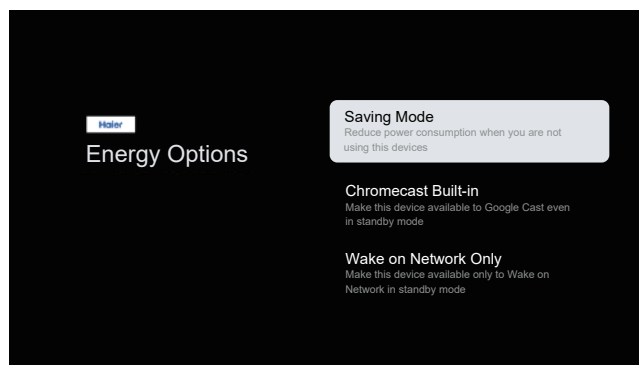

Selezionare "Saving Mode" (Modalità risparmio) e procedere al passo successivo.

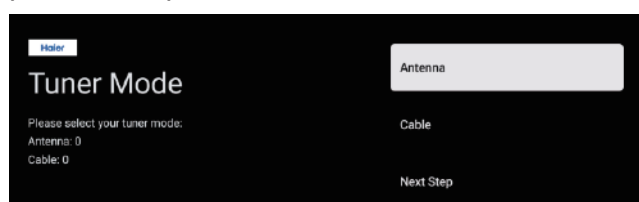

Selezionare la modalità "Tuner" (Sintonizzatore) per effettuare la ricerca, quindi premere OK per confermare.

ISTRUZIONI PER L'USO

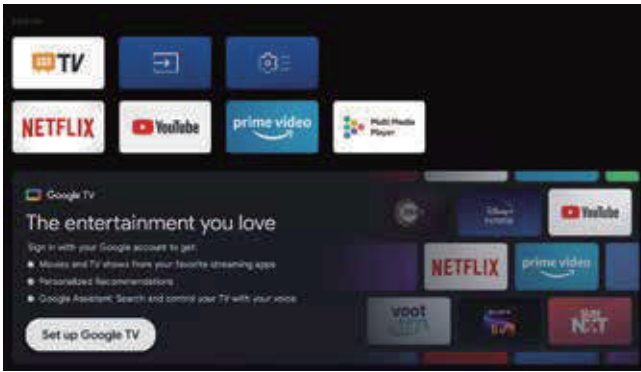

- Una volta entrati nell'interfaccia utente, è possibile passare dalle impostazioni di base del televisore alle impostazioni Google TV.

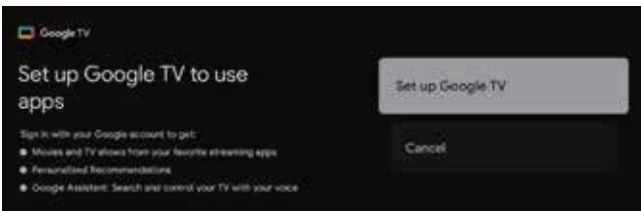

Premere ▲/▼ per selezionare "Set up Google TV" (Impostazione Google TV), quindi premere OK per completare l'impostazione.

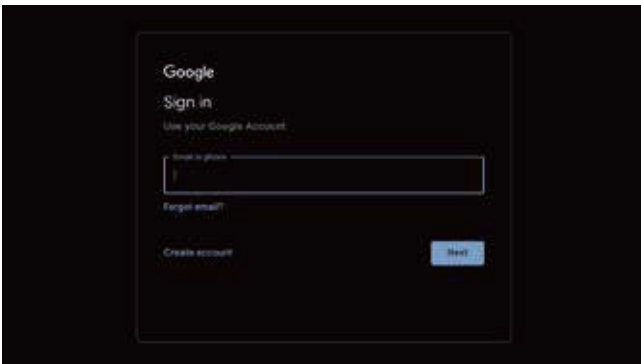

Utilizzare il proprio account Google per accedere

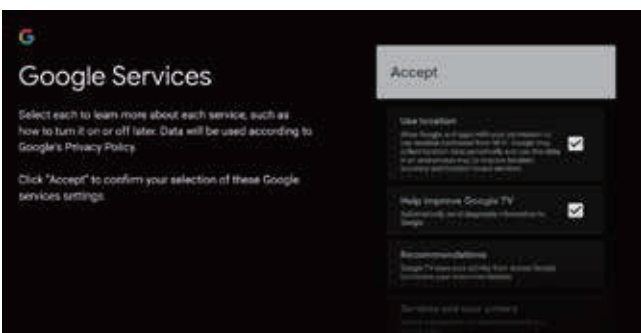
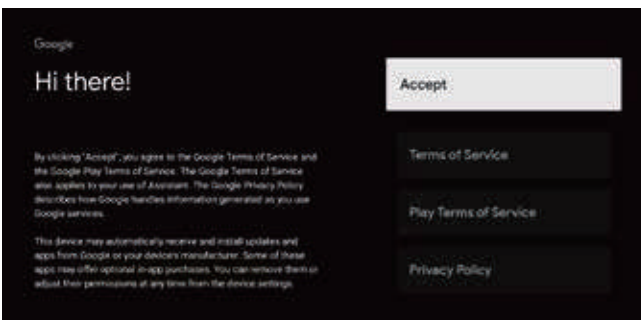

Selezionare "Accept" (Accetta) per accettare i Termini di Servizio di Google e migliorare l'esperienza del prodotto.

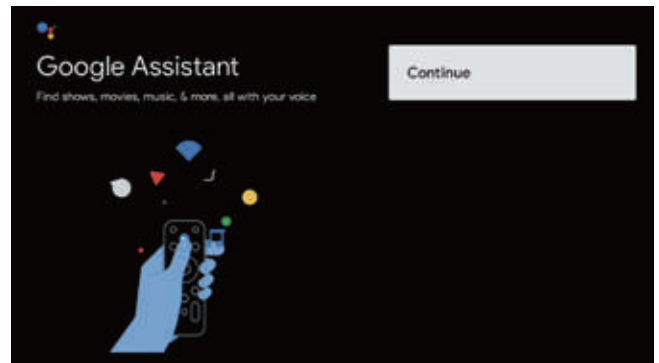

Premere per selezionare, quindi premere OK per continuare.

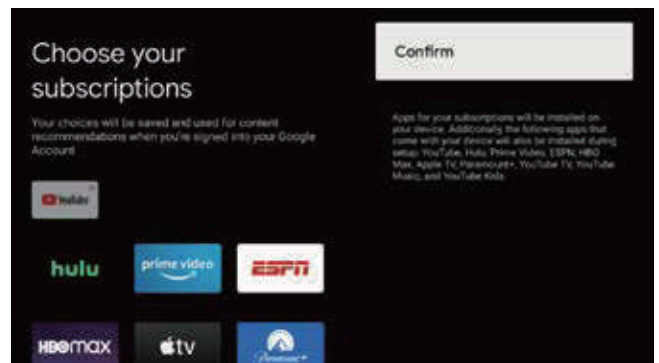

Premere ▲/▼ per selezionare l'opzione "Choose" (Scegli), quindi premere OK per confermare.

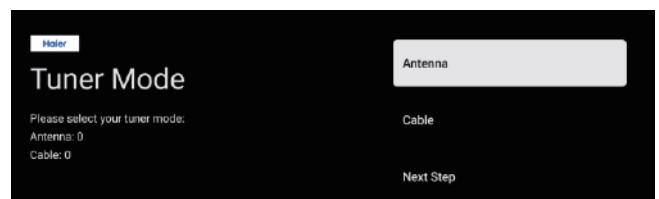

ISTRUZIONI PER L'USO

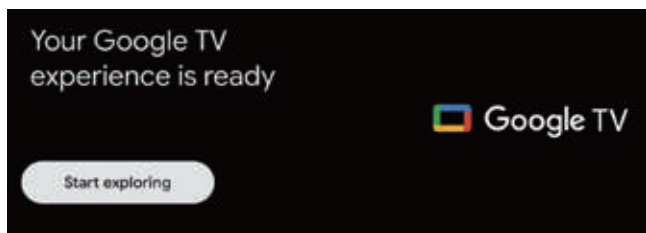

L'esperienza Google TV è pronta, quindi premere OK per iniziare l'esplorazione.

SCHEMATA INIZIALE

Dopo avere completato la procedura guidata, è possibile guardare la TV e accedere alla schermata iniziale.

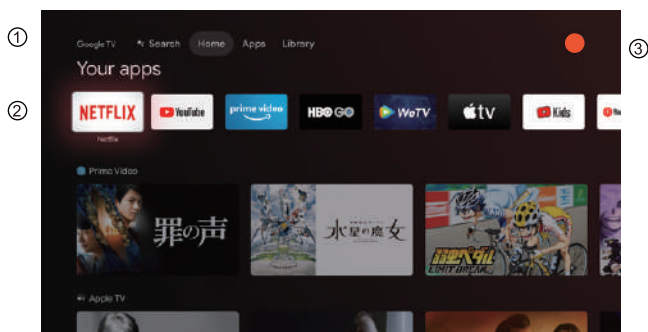

- ① **Search** Accedere all'assistente Google o avviare una ricerca vocale.
- Home** Accedere alla pagina Home del televisore.
- Apps** Accedere all'elenco delle applicazioni installate e aggiungere le applicazioni preferite.
- Library** Visualizzare i contenuti acquistati e noleggiati con il proprio account utente.
- ② Elenco delle applicazioni installate e dei contenuti push dei programmi installati.

- ③ Accedere alle informazioni sull'account, alle impostazioni, all'ora, agli ingressi e alle immagini.
 - ⊗ **Settings (Impostazioni)**: Qui è possibile configurare le diverse impostazioni. Per informazioni dettagliate sulle impostazioni, vedere la spiegazione successiva.
 - ⊗ **Inputs (Ingressi)**: Toccare l'icona per selezionare una sorgente di ingresso.
 - ⊗ **Picture (Immagine)**: L'utente può impostare la qualità delle immagini del televisore. Vedere pagina 12 per istruzioni dettagliate sull'impostazione.

MODALITÀ DI NAVIGAZIONE DEL MENU SUL DISPLAY

Ci sono due modi per procedere: Primo: alla voce Live TV, premere il pulsante Menu per visualizzare le opzioni del televisore, premere ▲/▼/◀/▶ per selezionare il menu delle impostazioni, quindi premere OK per confermare. Secondo: nell'interfaccia HOME, premere il tasto ▶ per selezionare l'icona del menu ⚙️, quindi premere OK per confermare.

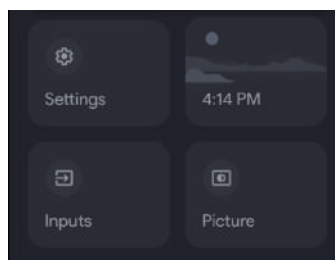
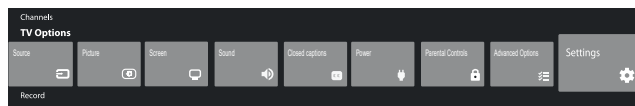

Premere il pulsante ▲/▼ per selezionare l'impostazione desiderata. Premere OK per accedere all'impostazione.

ISTRUZIONI PER L'USO

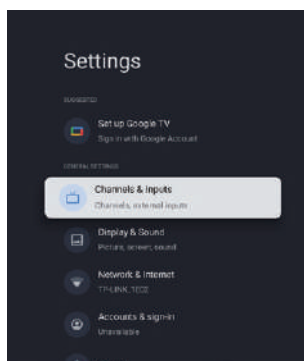

Premere **INDIETRO** per tornare al menu precedente. Se è visualizzato il menu principale, premendo **INDIETRO** si chiude il menu sullo schermo.

CANALI

Menu -> Settings -> Channels & Inputs -> Channels (Menu->Impostazioni->Canali e ingressi->Canali).

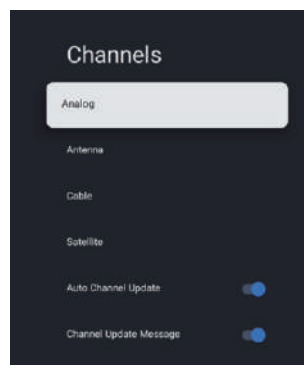

Analog/Antenna/Cable/Satellite (Analogico/Antenna/Cavo/Satellite) - Premere il pulsante **▲/▼** per selezionare l'opzione desiderata, quindi premere il pulsante **OK** per accedere al sottomenu.

Auto Channel Update (Aggiornamento automatico canale) - Premere il pulsante **OK** e selezionare **ON/OFF (Attivo/Disattivo)**. Selezionando **ON (Attivo)**, il sistema esegue automaticamente la scansione e l'aggiornamento dei canali dopo 5 minuti in standby.

Channel Update Message (Messaggio di aggiornamento canale) - Premere il pulsante **OK** e selezionare **ON/OFF (Attivo/Disattivo)**. Selezionando **ON (Attivo)**, il sistema mostrerà il messaggio di aggiornamento.

Nota: la sorgente disponibile potrebbe variare a seconda del modello.

INGRESSI

Menu->Impostazioni->Canali e ingressi->Ingressi

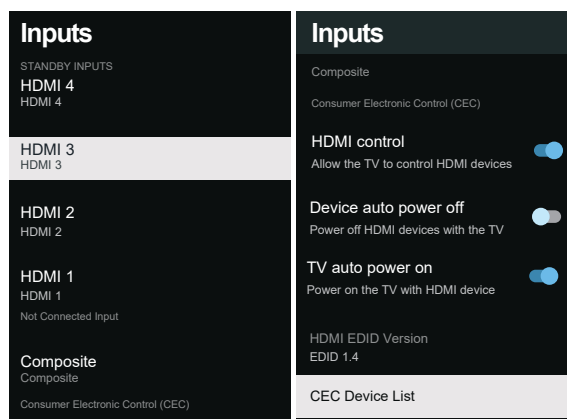

Inputs (Ingressi) – Premere **▲/▼** per selezionare l'opzione desiderata quindi premere **OK** per accedere al sottomenu.

HDMI control (Controllo HDMI) – Premere **▲/▼** per selezionare l'opzione desiderata, quindi premere **OK** per selezionare ON/OFF.

Device auto power off (Spegnimento automatico del dispositivo) - Premere **▲/▼** per selezionare l'opzione desiderata, quindi premere **OK** per selezionare ON/OFF.

TV auto power on (Accensione automatica del televisore) – Premere **▲/▼** per selezionare l'opzione desiderata, quindi premere **OK** per selezionare ON/OFF.

HDMI EDID Version (Versione HDMI EDID) - Visualizza la versione EDID.

CEC Device List (Elenco dispositivi CEC) Premere **▲/▼** per selezionare l'opzione desiderata quindi premere **OK** per accedere al sottomenu.

ISTRUZIONI PER L'USO

DISPLAY E AUDIO

Menu->Impostazioni->Display e audio
In questo menu è possibile impostare l'immagine, l'audio e l'uscita audio del televisore.

1. Premere il pulsante ▲/▼ per selezionare l'impostazione desiderata.
2. Premere il pulsante OK per confermare.
3. Una volta eseguita la regolazione, premere il pulsante **INDIETRO** per tornare al menu precedente.

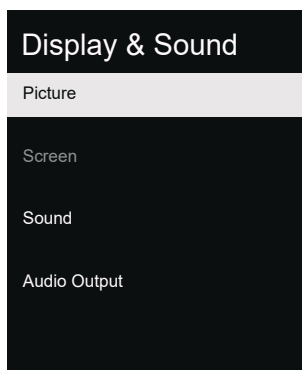

IMMAGINI

Menu->Impostazioni->Display e audio->Immagine.

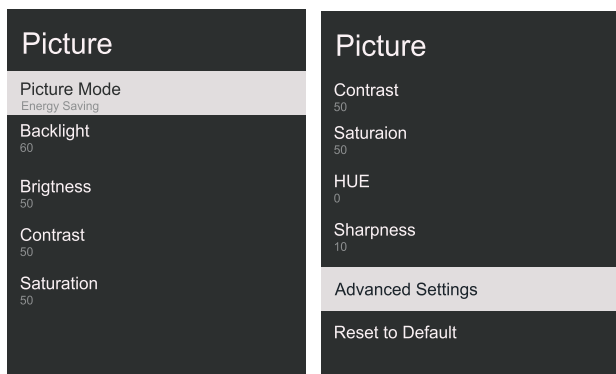

Picture Mode (Modalità immagine) - Premere ▲/▼ per selezionare l'opzione desiderata, quindi premere OK per accedere al sottomenu. (Opzionale: utente, standard, vivido, sport, film, gioco, risparmio energetico).
Backlight/Brightness/Contrast/Saturation/HUE/Sharpness (Retroilluminazione/luminosità/contrasto/saturazione/tonalità/nitidezza) - Premere ▲/▼ per selezionare l'opzione desiderata, quindi premere il pulsante OK per accedervi. Premere ◀ per diminuire il parametro. Premere ▶ per aumentare il parametro.
Advanced Settings (Impostazioni avanzate) - Premere ▲/▼ per selezionare l'opzione desiderata, quindi premere OK per accedere al sottomenu.
Reset to Default (Ripristino delle impostazioni predefinite) - Ripristina tutte le impostazioni predefinite.

SOUND

Menu->Impostazioni->Display e audio->Audio.

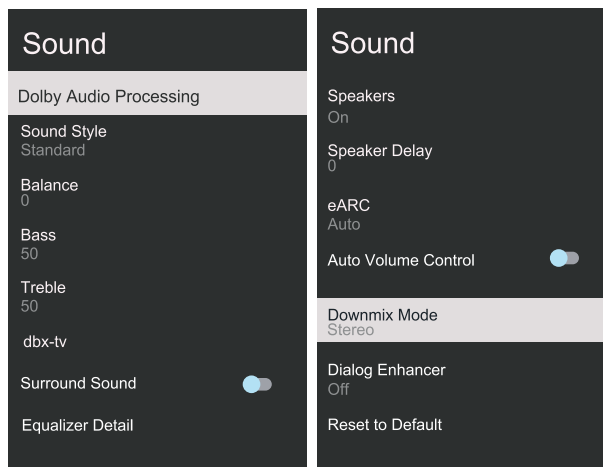

Dolby Audio processing (Elaborazione audio Dolby) - Premere ▲/▼ per selezionare l'opzione desiderata, quindi premere OK per accedere al sottomenu.

Sound style (Stile audio) - Premere ▲/▼ per selezionare l'opzione desiderata, quindi premere OK per accedere al sottomenu.

(Opzionale: utente, standard, notte, sport, film, musica, notizie).

Balance / Bass / Treble (Bilanciamento / Bassi / Acuti) - Premere ▲/▼ per selezionare l'opzione desiderata, quindi premere OK per accedervi.

Premere ◀ per diminuire il parametro.

Premere ▶ per aumentare il parametro.

dbx- tv Premere ▲/▼ per selezionare l'opzione desiderata, quindi premere OK per accedere al sottomenu.

Surround Sound (Audio surround) – Premere ▲/▼ per selezionare l'opzione desiderata, quindi premere OK per selezionare ON/OFF.

Equalizer Detail (Dettagli equalizzatore) - Premere ▲/▼ per selezionare l'opzione desiderata, quindi premere OK per accedere al sottomenu.

Speakers (Altoparlanti) – Premere ▲/▼ per selezionare l'opzione desiderata, quindi premere OK per selezionare ON/OFF.

Speaker Delay (Ritardo altoparlante) - Premere ▲/▼ per selezionare l'opzione desiderata, quindi premere OK per accedervi.

Premere ◀ per diminuire il parametro. Premere ▶ per aumentare il parametro.

eARC – Premere ▲/▼ per selezionare l'opzione desiderata, quindi premere OK per selezionare Automatico/OFF.

Auto Volume Control (Controllo automatico del volume) – Premere ▲/▼ per selezionare l'opzione desiderata, quindi premere OK per selezionare ON/OFF.

Downmix Mode (Modalità Downmix) - Premere ▲/▼ per selezionare l'opzione desiderata, quindi premere OK per accedere al sottomenu. (Opzionale: stereo, surround).

ISTRUZIONI PER L'USO

Dialog Enhancer (Miglioramento del dialogo) -

Premere ▲/▼ per selezionare l'opzione desiderata, quindi premere OK per accedere al sottomenu. (Opzionale: disattivato, basso, medio e alto).

Reset to Default (Ripristino delle impostazioni predefinite) – Ripristina tutte le impostazioni predefinite.

USCITA AUDIO

Menu->Impostazioni->Display e audio->Uscita audio.

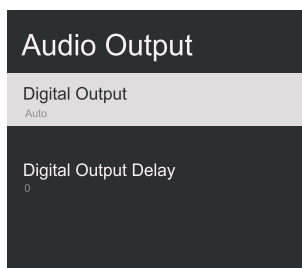

Digital Output (Uscita digitale) - Premere ▲/▼ per selezionare l'opzione desiderata, quindi premere OK per accedere al sottomenu. (Opzionale: Automatico, Bypass, PCM, Dolby Digital Plus e Dolby Audio-Dolby Digital).

Digital Output Delay (Ritardo uscita altoparlante) - Premere ▲/▼ per selezionare l'opzione desiderata, quindi premere OK per accedervi. Premere ◀ per diminuire il parametro. Premere ▶ per aumentare il parametro.

RETE

Menu->Impostazioni->Rete e Internet

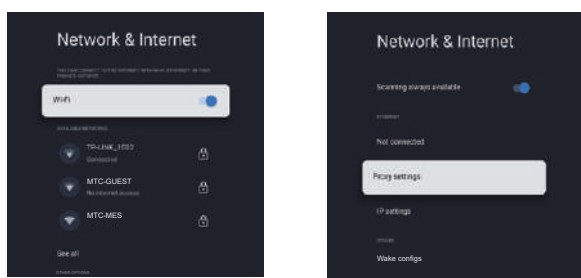

1. Premere il pulsante ▲/▼ per selezionare l'impostazione desiderata.
2. Premere il pulsante OK per confermare.
3. Una volta eseguita la regolazione, premere il pulsante OK per salvare e tornare al menu precedente.

ACCOUNT E ACCESSO

1. Menu->Impostazioni->Account e accesso.
2. Nell'interfaccia HOME, premere ▲/▼ per selezionare "Set up Google TV" (Imposta Google TV) e procedere al passo successivo.

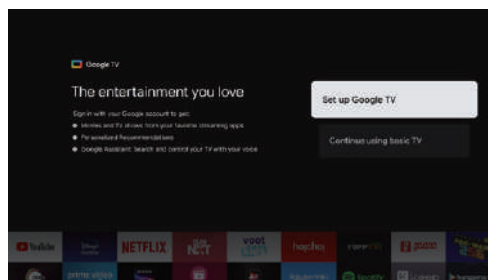

Selezionare "Set up Google TV" (Imposta Google TV) e procedere al passo successivo, inserendo l'account e la password.

Seguire le indicazioni per completare le impostazioni pertinenti.

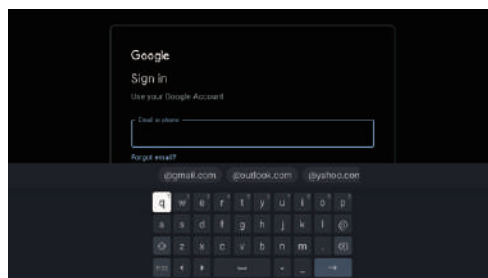

PRIVACY

Menu->Impostazioni->Privacy.

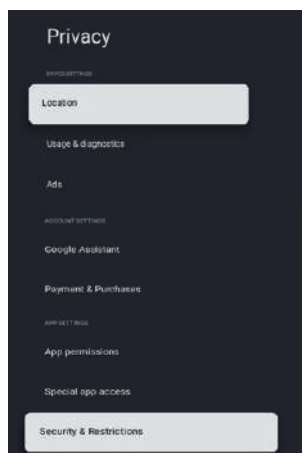

In questo menu è possibile impostare la posizione, l'uso e la diagnostica, ecc. del televisore.

1. Premere il pulsante ▲/▼ per selezionare l'impostazione desiderata.
2. Premere il pulsante OK per confermare.
3. Una volta eseguita la regolazione, premere il pulsante INDIETRO per tornare al menu precedente.

ISTRUZIONI PER L'USO

POSIZIONE

Menu->Impostazioni->Privacy->Posizione.

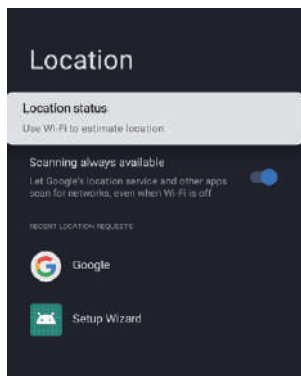

Digital Output Delay (Stato della posizione) –

Premere ▲/▼ per selezionare l'opzione desiderata, quindi premere OK per accedere al sottomenu. (Opzionale: usare il Wi-Fi per stimare la posizione, disattivato)

Scanning always available (Scansione sempre disponibile) – Premere ▲/▼ per selezionare l'opzione desiderata, quindi premere OK per selezionare ON/OFF.

USO E DIAGNOSTICA

Menu->Impostazioni->Privacy->Uso e diagnostica

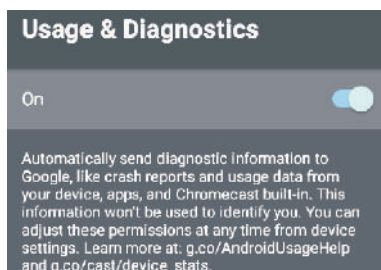

Usage & diagnostics (Uso e diagnostica) – Premere ▲/▼ per selezionare l'opzione desiderata, quindi premere OK per selezionare ON/OFF.

APPLICAZIONI

Menu->Impostazioni->Applicazioni.

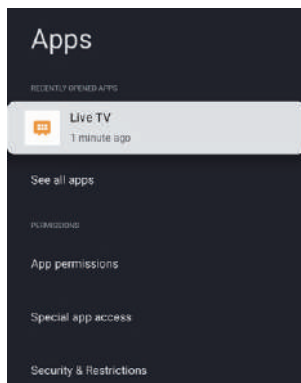

In questo menu è possibile impostare le autorizzazioni dell'APP e consultare gli elenchi delle applicazioni

1. Premere il pulsante ▲/▼ per selezionare l'impostazione desiderata.
2. Premere il pulsante OK per confermare.
3. Una volta eseguita la regolazione, premere il pulsante INDIETRO per tornare al menu precedente.

SISTEMA

Menu->Impostazioni->Sistema.

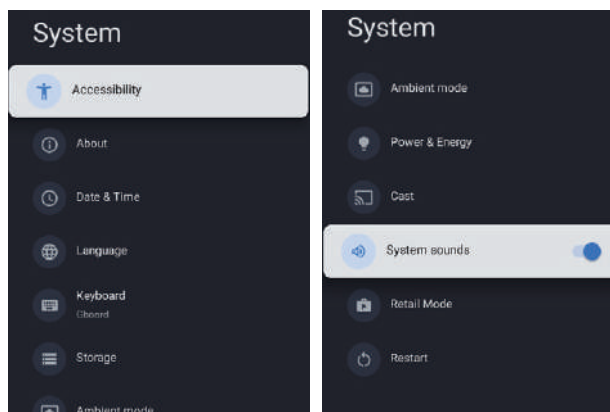

In questo menu è possibile consultare le informazioni e le impostazioni del televisore.

1. Premere il pulsante ▲/▼ per selezionare l'impostazione desiderata.
2. Premere il pulsante OK per confermare.
3. Una volta eseguita la regolazione, premere il pulsante INDIETRO per tornare al menu precedente.

System sounds (Audio di sistema) - Premere ▲/▼ per selezionare l'opzione desiderata, quindi premere OK per selezionare ON/OFF.

Per i dettagli sul sistema, vedere la spiegazione successiva.

ACCESSIBILITÀ

Menu->Impostazioni->Sistema->Accessibilità.

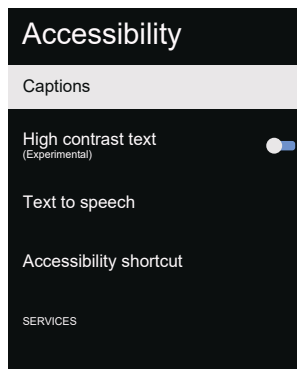

Didascalie - Premere ▲/▼ per selezionare l'opzione desiderata quindi premere OK per accedere al sottomenu.

High contrast text (Testo ad alto contrasto) – Premere ▲/▼ per selezionare l'opzione desiderata, quindi premere OK per selezionare ON/OFF.

ISTRUZIONI PER L'USO

Text to speech (Dal testo al discorso) - Premere ▲/▼ per selezionare l'opzione desiderata, quindi premere OK per accedere al sottomenu.

Accessibility shortcut (Scorciatoie per accedere) - Premere ▲/▼ per selezionare l'opzione desiderata, quindi premere OK per accedere al sottomenu.

INFORMAZIONI

Menu->Impostazioni->Sistema->Informazioni.

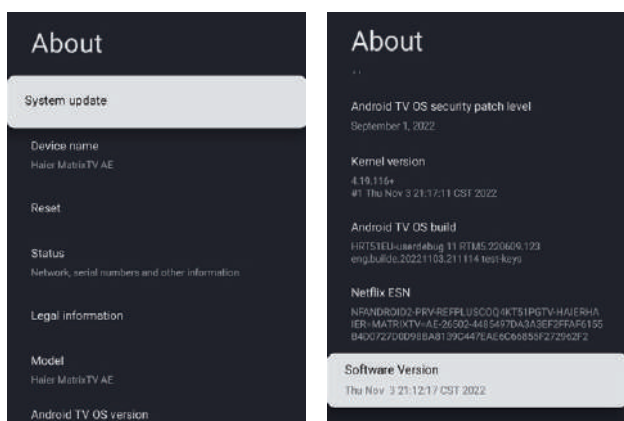

In questo menu è possibile effettuare l'aggiornamento del sistema, il reset e consultare le informazioni del televisore.

1. Premere il pulsante ▲/▼ per selezionare l'impostazione desiderata.
2. Premere il pulsante OK per confermare.
3. Una volta eseguita la regolazione, premere il pulsante INDIETRO per tornare al menu precedente.

DATA E ORA

Menu->Impostazioni->Sistema->Data e ora.

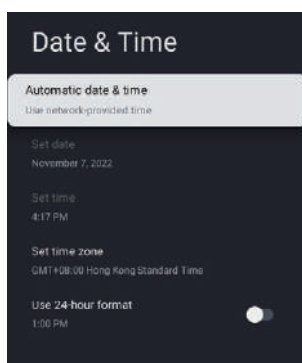

Automatic date & time (Impostazione automatica data e ora) - Premere ▲/▼ per selezionare l'opzione desiderata, quindi premere OK per accedere al sottomenu.

(Opzionale: usare l'orario fornito dalla rete, Off)

NOTE

- Quando la funzione Automatic date & time (Data e ora automatiche) è disattivata, è possibile regolare manualmente la data e l'ora.

Set date (Impostazione data) - Premere ▲/▼ per selezionare l'opzione desiderata, quindi premere OK per accedere al sottomenu.

Set time (Impostazione ora) - Premere ▲/▼ per selezionare l'opzione desiderata, quindi premere OK per accedere al sottomenu.

Set time zone (Impostazione fuso orario) - Premere ▲/▼ per selezionare l'opzione desiderata, quindi premere OK per accedere al sottomenu.

Use 24-hour format (Utilizzo formato 24 ore) - Premere ▲/▼ per selezionare l'opzione desiderata, quindi premere OK per selezionare ON/OFF.

LINGUA

Menu->Impostazioni->Sistema->Lingua.

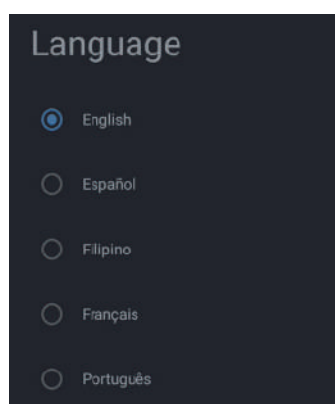

Language (Lingua) - Premere ▲/▼ per selezionare l'opzione desiderata quindi premere OK per accedere alla lingua selezionata.

TASTIERA

Menu->Impostazioni->Sistema->Tastiera.

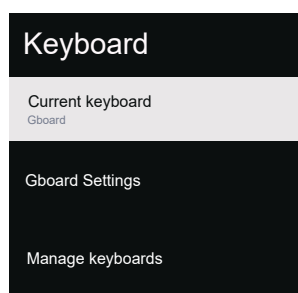

Current keyboard (Tastiera corrente) - Premere ▲/▼ per selezionare l'opzione desiderata, quindi premere OK per accedere al sottomenu.

Gboard Settings (Impostazioni Gboard) - Premere ▲/▼ per selezionare l'opzione desiderata, quindi premere OK per accedere al sottomenu.

Manage keyboards (Gestione tastiere) - Premere ▲/▼ per selezionare l'opzione desiderata, quindi premere OK per accedere al sottomenu.

ISTRUZIONI PER L'USO

MEMORIZZAZIONE

Menu->Impostazioni->Sistema->Memorizzazione.

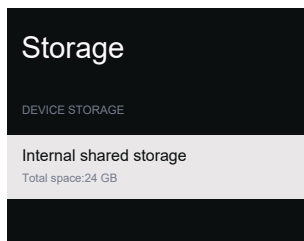

Internal shared storage (Memoria interna condivisa)

- Premere ▲/▼ per selezionare l'opzione desiderata, quindi premere OK per accedere al sottomenu.

MODALITÀ AMBIENTE

Menu->Impostazioni->Sistema->Modalità ambiente.

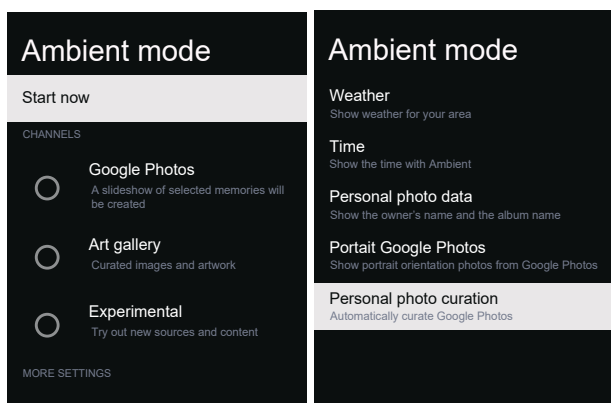

In questo menu è possibile impostare la modalità ambiente.

1. Premere ▲/▼ per selezionare l'impostazione desiderata.
2. Premere il pulsante OK per confermare.
3. Una volta eseguita la regolazione, premere il pulsante INDIETRO per tornare al menu precedente.

POTENZA ED ENERGIA

Menu->Impostazioni->Sistema->Potenza ed energia.

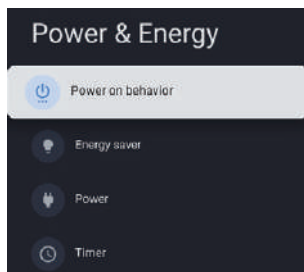

In questo menu è possibile impostare la potenza e l'energia

(accensione, risparmio energetico, alimentazione e timer)

1. Premere il pulsante ▲/▼ per selezionare l'impostazione desiderata.
2. Premere il pulsante OK per confermare.
3. Una volta eseguita la regolazione, premere

il pulsante INDIETRO per tornare al menu precedente.

ACCENSIONE

Menu->Impostazioni->Sistema->Potenza ed energia->Accensione.

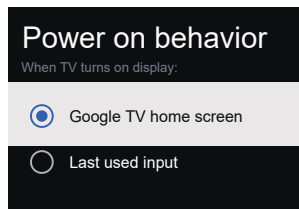

Premere ▲/▼ per selezionare l'opzione desiderata, quindi premere OK per confermare.

RISPARMIO ENERGETICO

Menu->Impostazioni->Sistema->Potenza ed energia->Risparmio energetico.

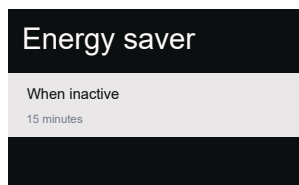

When inactive (Non attivo) - Premere ▲/▼ per selezionare l'opzione desiderata, quindi premere OK per accedere al sottomenu. (Opzionale: 15 minuti, 20 minuti, 30 minuti, 1 ora, 4 ore, 8 ore, 12 ore, 24 ore, mai).

ALIMENTAZIONE

Menu->Impostazioni->Sistema->Potenza ed energia->Potenza.

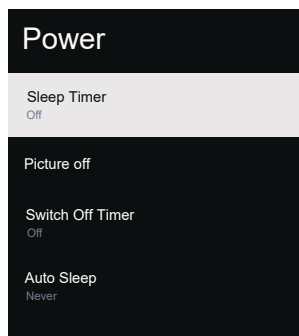

Sleep Timer (Timer di spegnimento automatico) - Premere ▲/▼ per selezionare l'opzione desiderata, quindi premere OK per accedere al sottomenu. (Opzionale: spento, 10 minuti, 20 minuti, 30 minuti, 40 minuti, 50 minuti, 60 minuti, 90 minuti, 120 minuti)

Picture off (Immagine disattivata) - ▲/▼ per selezionare l'opzione desiderata, quindi premere OK per confermare.

Switch off timer (Timer di spegnimento) - Premere ▲/▼ per selezionare l'opzione desiderata, quindi premere OK per accedere al sottomenu.

ISTRUZIONI PER L'USO

(Opzionale: spento, 30 minuti, 60 minuti, 90 minuti, 120 minuti, 150 minuti, 180 minuti, 210 minuti, 240 minuti)

Auto Sleep (Spegnimento automatico) - Premere ▲/▼ per selezionare l'opzione desiderata, quindi premere **OK** per accedere al sottomenu.
(Opzionale: mai, 4 ore, 6 ore, 8 ore)

TIMER

Menu->Impostazioni->Sistema->Potenza ed energia->Timer.

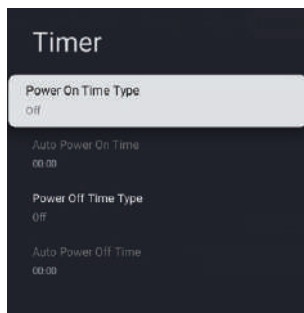

Power On Time Type (Ora di accensione) - Premere ▲/▼ per selezionare l'opzione desiderata, quindi premere il pulsante **OK** per selezionare OFF/ON/UNA VOLTA.

Auto Power On Time (Ora di accensione) automatica - Premere ▲/▼ per selezionare l'opzione desiderata, quindi premere **OK** per accedere al sottomenu.

Power Off Time Type (Ora di spegnimento) - Premere ▲/▼ per selezionare l'opzione desiderata, quindi premere il pulsante **OK** per selezionare OFF/ON/UNA VOLTA.

Auto Power Off Time (Ora di spegnimento) automatico - Premere ▲/▼ per selezionare l'opzione desiderata, quindi premere **OK** per accedere al sottomenu.

TRASMISSIONE

Menu->Impostazioni->Sistema->Trasmissione.

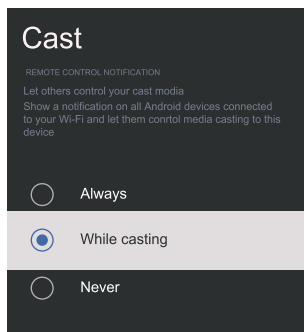

1. Premere il pulsante ▲/▼ per selezionare l'impostazione desiderata.
2. Premere il pulsante **OK** per confermare.
3. Premere il pulsante **INDIETRO** per tornare al menu precedente.

MODALITÀ RETAIL

Menu->Impostazioni->Sistema->Modalità Retail.

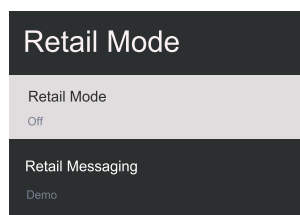

Retail mode (Modalità Retail) Premere ▲/▼ per selezionare l'opzione desiderata, quindi premere **OK** per selezionare ON/OFF.

Retail messaging (Messaggi Retail) - Premere ▲/▼ per selezionare l'opzione desiderata, quindi premere **OK** per accedere al sottomenu. (Nota: Demo, e-POP, e-POP + Demo)

RIAVVIO

Menu->Impostazioni->Sistema->Riavvio.

Premere il pulsante **OK** per accedere al sottomenu.
(Opzionale: riavviare e annullare)

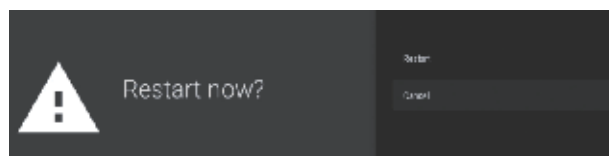

TELECOMANDI E ACCESSORI

Menu->Impostazioni->Telecomandi e accessori.

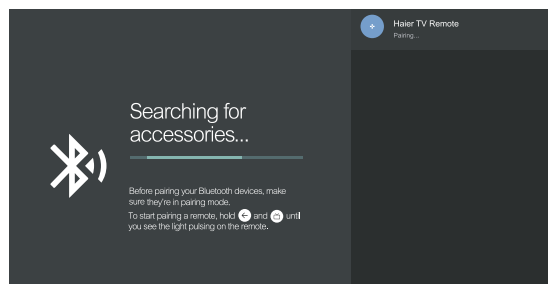
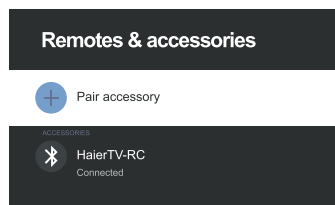

In questo menu è possibile abbinare i dispositivi Bluetooth.

1. Premere i pulsanti "←" e "⏻" nella parte inferiore del telecomando per 5 secondi.
2. Quando il LED inizia a lampeggiare, rilasciarli. Il telecomando invia il segnale di abbinamento al televisore e visualizza le informazioni del telecomando sul lato destro dello schermo.
3. Premere il pulsante **OK** per visualizzare l'abbinamento. Se viene visualizzato il

ISTRUZIONI PER L'USO

messaggio "Abbinamento riuscito", significa che la connessione è stata eseguita con successo.

4. Se viene visualizzato il messaggio "Abbinamento non possibile", significa che la connessione non è riuscita. Attendere 30 secondi, quindi premere per 5 secondi i pulsanti "←" e "📺" nella parte inferiore del telecomando per ripetere i passaggi precedenti.
5. Premere "←" per tornare al menu precedente.

UTILIZZO DEL LETTORE MULTIMEDIALE

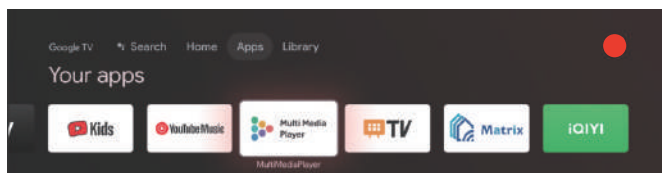

1. Nell'interfaccia HOME o APP, premere ▲/▼/◀/▶ per selezionare l'applicazione "Multi Media Player" (Lettore multimediale)

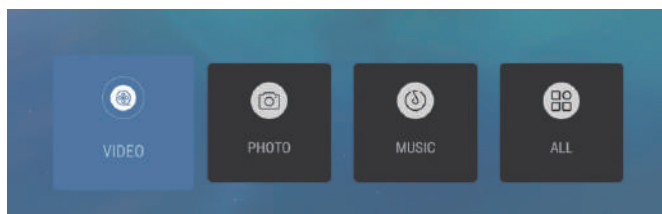

2. Selezionare il tasto OK per accedere a "Multi Media Player" (Lettore multimediale) e visualizzare video, foto e audio. Dopo avere inserito l'unità flash USB, è possibile visualizzare i file corrispondenti nell'unità flash USB (formato FAT32).

NOTE

Il menu potrebbe essere diverso a seconda della versione del televisore.

RISOLUZIONE DEI PROBLEMI

Prima di contattare l'assistenza, eseguire questi semplici controlli. Questi suggerimenti possono farvi risparmiare tempo e denaro, poiché le spese per l'installazione del ricevitore e la regolazione dei comandi del cliente non sono coperte dalla garanzia.

Sintomi	Elementi da controllare e azioni da eseguire
Effetto "fantasma" o doppia immagine	<ul style="list-style-type: none">Potrebbero essere causati da un'ostruzione dell'antenna dovuta ad edifici alti o a colline. L'uso di un'antenna direzionale può migliorare la qualità dell'immagine.
Mancanza di alimentazione	<ul style="list-style-type: none">Controllare se il cavo di alimentazione CA del televisore è inserito nella presa.Scollegare il televisore e attendere 60 secondi. Inserire nuovamente la spina di alimentazione nella presa e riaccendere il televisore.
Nessuna immagine	<ul style="list-style-type: none">Controllare le connessioni dell'antenna sul retro del televisore per verificare che sia collegata correttamente al televisore.Possibili problemi della stazione di trasmissione. Provare con un altro canale.Regolare le impostazioni del contrasto e della luminosità.Verificare che il controllo delle didascalie sia chiuso. Alcune modalità di TESTO potrebbero bloccare lo schermo.
Buona qualità dell'immagine ma nessun audio	<ul style="list-style-type: none">Premere il pulsante SILENZIOSO sul telecomando per visualizzare il menu principale.
Buona qualità del suono ma colore scadente	<ul style="list-style-type: none">Regolare le impostazioni del contrasto, del colore e della luminosità.
Immagine scadente	<ul style="list-style-type: none">La qualità dell'immagine può risultare scadente quando una fotocamera o una videocamera S-VHS attivata è collegata contemporaneamente al televisore e ad altre unità periferiche. Spegnerne una delle unità periferiche.
Immagine offuscata e rumore	<ul style="list-style-type: none">Controllare il collegamento dell'antenna.
Linea orizzontale tratteggiata	<ul style="list-style-type: none">Il problema potrebbe essere causato da un'interferenza elettrica (ad esempio, un asciugacapelli, luci al neon nelle vicinanze, ecc.). Spegnerne queste apparecchiature.
Il televisore non risponde al telecomando	<ul style="list-style-type: none">Controllare se le batterie funzionano. Sostituire se necessario.Pulire la lente del sensore del telecomando sul televisore.
I pixel (punti) sono sempre scuri o sempre illuminati	<ul style="list-style-type: none">Il televisore è realizzato con precisione e con un livello di tecnologia estremamente elevato. Tuttavia, a volte i pixel non vengono visualizzati correttamente. Questi tipi di eventi sono caratteristici del prodotto e non costituiscono un difetto.

NOTE

- Questo prodotto utilizza un pannello composto da sub-pixel che richiede una sofisticata tecnologia di realizzazione. Tuttavia, sullo schermo potrebbero essere presenti alcuni pixel chiari o scuri. Questi pixel non hanno alcun impatto sulle prestazioni del prodotto.



I termini HDMI, interfaccia multimediale HDMI ad alta definizione, i tratti distintivi di HDMI e i loghi HDMI sono marchi o marchi registrati di HDMI Licensing Administrator, Inc.



Dolby, Dolby Vision, Dolby Atmos, Dolby Audio e il simbolo della doppia D sono marchi commerciali di Dolby Laboratories Licensing Corporation. Prodotto su licenza di Dolby Laboratories. Opere inedite riservate. Copyright ©2012-2024 Dolby Laboratories. Tutti i diritti riservati.

SPECIFICHE DEL PRODOTTO

TV LED 43" UHD

Qualità dell'immagine del televisore:	UHD Digitale integrato. Dimensioni dello schermo: 108 cm Risoluzione 3840x2160 pixel 60 Hz.
Sistema del televisore:	PAL-B/G, SECAM-B/G
Decoder con sintonizzatore DTV	DVB-T, DVB-C, DVB-T2, DVB-S2 Modulazione QAM 16/32/64/128/256 MPEG2, MPEG4, H.265
Connettività:	1 porta ottica 2 porte USB 1 LAN 4 prese HDMI 1 presa VIDEO 1 presa S 1 presa D 2 prese RF 1 porta per AURICOLARI 1 slot CI Sistemi supportati: PAL+SECAM Numero di canali di archiviazione: 1000 (DTV), 100 (ATV) TV (RF): 75 Ω Non bilanciato Ingresso video AV: 75 Ω, 1 V-P, RCA Ingresso audio AV: 20 KΩ, 500 mV RMS Ingresso video HDMI: 480i, 480p, 720p, 1080i, 1080p, 2160p Wi-Fi: Standard: IEEE 802.11 a/b/g/n/ac, Frequenza: 2,4 Ghz ~ 5 GHz Bluetooth: V5.1
Qualità del suono:	Sistema audio stereo. 2 x 10 watt RMS potenza in uscita.
Consumo di energia in stand-by	≤0,5 W
Funzionalità digitali:	Interattivo digitale. Testo digitale. Sono disponibili sottotitoli per la trasmissione video digitale (DVB). Impostazione automatica. Scansione automatica di nuovi canali. Guida ai programmi attuali e successivi. Guida elettronica ai programmi di 7 giorni (EPG). Slot CI. Compatibile con la descrizione audio.
Funzionalità aggiuntive:	Sintonizzatore UHF/VHF; timer di spegnimento automatico; parental control; immagine e testo Batterie del telecomando: 2 x AAA. Dimensioni VESA: 300 x 300 mm Dimensioni della confezione (LxAxP): 1075 x 652 x 142 mm Dimensioni del televisore (LxAxP) con supporto: 957,2 x 607,4 x 240,7 mm Dimensioni del televisore (LxAxP) senza supporto: 957,2 x 566,7 x 86,6 mm Peso della confezione: 10 kg Peso del televisore con supporto: 7,2 kg Peso del televisore senza supporto: 6,8 kg

* Le specifiche dei componenti di questo televisore sono fornite solo a titolo di riferimento. Possono esservi delle differenze a seconda delle versioni dei prodotti di volta in volta aggiornati. Design e specifiche sono soggetti a modifiche senza preavviso.

SPECIFICHE DEL PRODOTTO

TV LED 50" UHD

Qualità dell'immagine del televisore:	UHD Digitale integrato. Dimensioni dello schermo: 126cm Risoluzione 3840x2160 pixel 60 Hz.
Sistema del televisore:	PAL-B/G, SECAM-B/G
Decoder con sintonizzatore DTV	DVB-T, DVB-C, DVB-T2, DVB-S2 Modulazione QAM 16/32/64/128/256 MPEG2, MPEG4, H.265
Connettività:	1 porta ottica 2 porte USB 1 LAN 4 prese HDMI 1 presa VIDEO 1 presa S 1 presa D 2 prese RF 1 porta per AURICOLARI 1 slot CI Sistemi supportati: PAL+SECAM Numero di canali di archiviazione: 1000 (DTV), 100 (ATV) TV (RF): 75 Ω Non bilanciato Ingresso video AV: 75 Ω, 1 V-P, RCA Ingresso audio AV: 20 KΩ, 500 mV RMS Ingresso video HDMI: 480i, 480p, 720p, 1080i, 1080p, 2160p Wi-Fi: Standard: IEEE 802.11 a/b/g/n/ac, Frequenza: 2,4 Ghz ~ 5 GHz Bluetooth: V5.1
Qualità del suono:	Sistema audio stereo. 2 x 13.5 watt RMS potenza in uscita.
Consumo di energia in stand-by	≤0,5 W
Funzionalità digitali:	Interattivo digitale. Testo digitale. Sono disponibili sottotitoli per la trasmissione video digitale (DVB). Impostazione automatica. Scansione automatica di nuovi canali. Guida ai programmi attuali e successivi. Guida elettronica ai programmi di 7 giorni (EPG). Slot CI. Compatibile con la descrizione audio.
Funzionalità aggiuntive:	Sintonizzatore UHF/VHF; timer di spegnimento automatico; parental control; immagine e testo Batterie del telecomando: 2 x AAA. Dimensioni VESA: 300 x 300 mm Dimensioni della confezione (LxAxP): 1250 x 760 x 144 mm Dimensioni del televisore (LxAxP) con supporto: 1111,2 x 710,5 x 277,2 mm Dimensioni del televisore (LxAxP) senza supporto: 1111,2 x 651,8 x 88 mm Peso della confezione: 13,5 kg Peso del televisore con supporto: 10 kg Peso del televisore senza supporto: 9,5 kg

* Le specifiche dei componenti di questo televisore sono fornite solo a titolo di riferimento. Possono esservi delle differenze a seconda delle versioni dei prodotti di volta in volta aggiornati. Design e specifiche sono soggetti a modifiche senza preavviso.

SPECIFICHE DEL PRODOTTO

TV LED 55" UHD

Qualità dell'immagine del televisore:	UHD Digitale integrato. Dimensioni dello schermo: 139 cm Risoluzione 3840x2160 pixel 60 Hz.
Sistema del televisore:	PAL-B/G, SECAM-B/G
Decoder con sintonizzatore DTV	DVB-T, DVB-C, DVB-T2, DVB-S2 Modulazione QAM 16/32/64/128/256 MPEG2, MPEG4, H.265
Connettività:	1 porta ottica 2 porte USB 1 LAN 4 prese HDMI 1 presa VIDEO 1 presa S 1 presa D 2 prese RF 1 porta per AURICOLARI 1 slot CI Sistemi supportati: PAL+SECAM Numero di canali di archiviazione: 1000 (DTV), 100 (ATV) TV (RF): 75 Ω Non bilanciato Ingresso video AV: 75 Ω, 1 V-P, RCA Ingresso audio AV: 20 KΩ, 500 mV RMS Ingresso video HDMI: 480i, 480p, 720p, 1080i, 1080p, 2160p Wi-Fi: Standard: IEEE 802.11 a/b/g/n/ac, Frequenza: 2,4 Ghz ~ 5 GHz Bluetooth: V5.1
Qualità del suono:	Sistema audio stereo. 2 x 13,5 watt RMS potenza in uscita.
Consumo di energia in stand-by	≤0,5 W
Funzionalità digitali:	Interattivo digitale. Testo digitale. Sono disponibili sottotitoli per la trasmissione video digitale (DVB). Impostazione automatica. Scansione automatica di nuovi canali. Guida ai programmi attuali e successivi. Guida elettronica ai programmi di 7 giorni (EPG). Slot CI. Compatibile con la descrizione audio.
Funzionalità aggiuntive:	Sintonizzatore UHF/VHF; timer di spegnimento automatico; parental control; immagine e testo Batterie del telecomando: 2 x AAA. Dimensioni VESA: 300 x 300 mm Dimensioni della confezione (LxAxP): 1350 x 837 x 144 mm Dimensioni del televisore (LxAxP) con supporto: 1225,8 x 777,3 x 277,2 mm Dimensioni del televisore (LxAxP) senza supporto: 1225,8 x 719,4 x 88,1 mm Peso della confezione: 16,4 kg Peso del televisore con supporto: 11,9 kg Peso del televisore senza supporto: 11,4 kg

* Le specifiche dei componenti di questo televisore sono fornite solo a titolo di riferimento. Possono esservi delle differenze a seconda delle versioni dei prodotti di volta in volta aggiornati. Design e specifiche sono soggetti a modifiche senza preavviso.

SPECIFICHE DEL PRODOTTO

TV LED 65" UHD

Qualità dell'immagine del televisore:	UHD Digitale integrato. Dimensioni dello schermo: 164cm Risoluzione 3840x2160 pixel 60 Hz.
Sistema del televisore:	PAL-B/G, SECAM-B/G
Decoder con sintonizzatore DTV	DVB-T, DVB-C, DVB-T2, DVB-S2 Modulazione QAM 16/32/64/128/256 MPEG2, MPEG4, H.265
Connettività:	1 porta ottica 2 porte USB 1 LAN 4 prese HDMI 1 presa VIDEO 1 presa S 1 presa D 2 prese RF 1 porta per AURICOLARI 1 slot CI Sistemi supportati: PAL+SECAM Numero di canali di archiviazione: 1000 (DTV), 100 (ATV) TV (RF): 75 Ω Non bilanciato Ingresso video AV: 75 Ω, 1 V-P, RCA Ingresso audio AV: 20 KΩ, 500 mV RMS Ingresso video HDMI: 480i, 480p, 720p, 1080i, 1080p, 2160p Wi-Fi: Standard: IEEE 802.11 a/b/g/n/ac, Frequenza: 2,4 Ghz ~ 5 GHz Bluetooth: V5.1
Qualità del suono:	Sistema audio stereo. 2 x 13,5 watt RMS potenza in uscita.
Consumo di energia in stand-by	≤0,5 W
Funzionalità digitali:	Interattivo digitale. Testo digitale. Sono disponibili sottotitoli per la trasmissione video digitale (DVB). Impostazione automatica. Scansione automatica di nuovi canali. Guida ai programmi attuali e successivi. Guida elettronica ai programmi di 7 giorni (EPG). Slot CI. Compatibile con la descrizione audio.
Funzionalità aggiuntive:	Sintonizzatore UHF/VHF; timer di spegnimento automatico; parental control; immagine e testo Batterie del telecomando: 2 x AAA. Dimensioni VESA: 400 x 300 mm Dimensioni della confezione (LxAxP): 1600 x 960 x 164 mm Dimensioni del televisore (LxAxP) con supporto: 1446,4 x 904,7 x 313,8 mm Dimensioni del televisore (LxAxP) senza supporto: 1446,4 x 841,3 x 85,1 mm Peso della confezione: 24 kg Peso del televisore con supporto: 17,2 kg Peso del televisore senza supporto: 16,5 kg

* Le specifiche dei componenti di questo televisore sono fornite solo a titolo di riferimento. Possono esservi delle differenze a seconda delle versioni dei prodotti di volta in volta aggiornati. Design e specifiche sono soggetti a modifiche senza preavviso.

Haier

Haier

Inspirert tilværelse

Brukerhåndbok

MODELLER:

H43Q80FUX

H50Q80FUX

H55Q80FUX

H65Q80FUX



Illustrasjonene i denne bruksanvisningen gis bare som referanse og kan variere fra det faktiske produktet.

Produktets design og spesifikasjoner kan endres uten forvarsel.

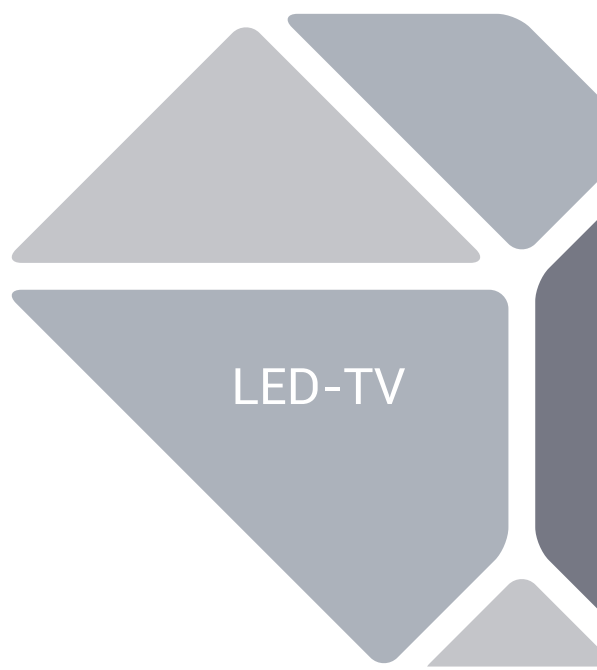

INNHold

1. VIKTIGE SIKKERHETSINSTRUKSJONER	1
2. FORBEREDELSE	3
3. TILKOBLING AV PERIFERIUTSTYR OG KONTROLLER	4
4. OPPRETT FORBINDELSER.....	5
5. BRUKSINSTRUKSJONER.....	6
6. FEILSØKING.....	18
7. PRODUKTSPESIFIKASJONER	19



Illustrasjonene i denne bruksanvisningen gis bare som referanse og kan variere fra det faktiske produktet. Produktets design og spesifikasjoner kan endres uten forvarsel.

VIKTIGE SIKKERHETSINSTRUKSJONER

- 1) Les disse instruksjonene nøye.
- 2) Ta vare på instruksjonene.
- 3) Overhold alle advarsler.
- 4) Følg alle instruksjonene.
- 5) Ikke bruk apparatet i nærheten av vann.
- 6) Rengjør bare med en tørr klut.
- 7) Ikke blokker noen ventilasjonsåpninger. Monter i henhold til instruksjonene.
- 8) Ikke monter i nærheten av varmekilder som radiatorer, ovner, komfyrer og andre innretninger (inkludert forsterkere) som produserer varme.
- 9) Ødelegg ikke sikkerhetsinnretningene til jordingspluggen. Hvis den medleverte pluggen ikke passer i din kontakt, må du forhøre deg med en elektriker for utskiftning av det overflødig uttaket.
- 10) Pass på at strømkabelen ikke trækkes på eller kommer i klem, især ved pluggen og kontakter, og stedet hvor de går ut av enheten.
- 11) Bruk kun tillegg/tilbehør som er spesifisert av produsenten.
- 12) Plugg ut apparatet ved tordenvær eller hvis den ikke skal brukes over lengre tid.
- 13) All service skal utføres av kvalifisert servicepersonell. Service er påkrevd hvis apparatet har blitt skadet på noen måte, sånn som hvis strømledningen eller pluggen har blitt skadet, hvis væske har blitt sølt på den eller gjenstander faller inn i enheten, hvis enheten har blitt utsatt for regn eller fuktighet, eller hvis enheten ikke virker normalt eller har falt ned.
- 14) Hvis strømpluggen brukes for frakobling, må frakoblingsenheten alltid være klar til bruk.
- 15) Ventilasjonen må ikke hindres ved å dekke til ventilasjonsåpningene med gjenstander som aviser, duker, gardiner osv.
- 16) Ingen åpne flammekilder som talglys må plasseres oppå apparatet.
- 17) Ta hensyn til miljøet når du skal kaste brukte batterier.
- 18) Bruk av apparater i moderat klima.
- 19) Apparatet må ikke utsettes for sprut/drypp av væske, og ingen væskefylte gjenstander som f.eks. vaser må settes på apparatet.
- 20) Advarsel: For å unngå skader forårsaket av at produktet lener seg mot noe, må du alltid sørge for at hele produktet er plassert horisontalt innenfor bordflaten.

* Faktisk produkt kan variere i utseende fra bildet ovenfor*

Hvis pluggen på strømledningen brukes som frakobling, vil monteringsveiledningen angi at for pluggbart utstyr, skal stikkkontakten være lett tilgjengelig.

	FORSIKTIG FARE FOR ELEKTRISK STØT Må ikke åpnes!	
FORSIKTIG FOR Å REDUSERE RISIKOEN FOR ELEKTRISK STØT MÅ IKKE DEKSLER TAS AV (ELLER BAKSIDEN). DET ER INGEN DELER BRUKEREN KAN UTFØRE SERVICE PÅ. KONTAKT KVALIFISERT SERVICEPERSONELL FOR SERVICE.		



Symbolet indikerer at farlige spenninger som utgjør en risiko for elektrisk støt er tilstede i denne enheten.



Symbolet indikerer at det er viktige bruks- og vedlikeholdsinstruksjoner i tekstene som følger med denne enheten.

ADVARSEL:

For å redusere risiko for brann eller elektrisk støt, må ikke apparatet utsettes for regn eller fuktighet.

ADVARSEL:

Batterier må ikke utsettes for sterk varme, som solskinn, flammer eller lignende.



Dette symbolet indikerer at dette produktet har dobbel isolasjon mellom farlig nettspenning og brukertilgjengelige deler. Ved service brukes kun identiske reservedeler.



Dette merket indikerer at dette produktet ikke skal kastes sammen med vanlig husholdningsavfall. For å unngå skade på miljø og helse som følge av tilfeldig avfallsavhandling må det kjøleskapet skilles fra andre typer avfall og leveres til gjenvinning. For å returnere ditt brukte apparat, brukes retur- og innsamlingsordninger, eller kontakt forhandleren hvor produktet ble kjøpt. De kan ta imot produktet for miljøvennlig resirkulering.

VIKTIGE SIKKERHETSINSTRUKSJONER

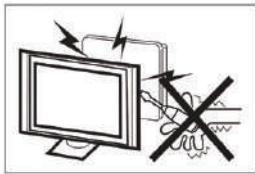

Det brukes høy spenning i driften av denne TV-mottakeren. Ikke fjern skapet bak på apparatet. Kontakt kvalifisert servicepersonell for service.

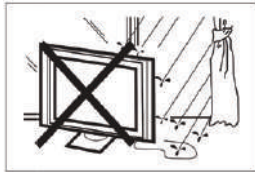

For å unngå fare for brann eller elektrisk støt, må ikke TV-mottakeren utsettes for regn eller fuktighet.



Ikke slipp eller skyv gjenstander inn i sporene eller åpningene på TV-kabinettet. Søl aldri noen form for væske på TV-mottakeren.



Ikke blokker ventilasjonshullene i bakdekselet. Tilstrekkelig ventilasjon er avgjørende for å forhindre svikt i elektriske komponenter.



Ikke klem strømledningen under TV-mottakeren.



Hvis du skal rengjøre produktet, må du koble fra TV-en. Bruk mykt stoff, ikke vann og aldri kjemikalier.



Du må aldri stå på, lene deg på eller plutselig skyve på TV-en eller stativet. Du bør være spesielt oppmerksom på barn. Alvorlig skade kan oppstå hvis den faller ned.

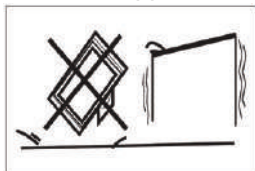

Ikke plasser dette TV-en på en ustabil tralle, et stativ eller et bord. Alvorlig personskade og skade på TV-en kan oppstå hvis den faller ned.



Hvis TV-mottakeren ikke skal brukes på en lengre periode, anbefales det å koble strømledningen fra stikkkontakten.



TV-mottakeren må ikke utsettes for direkte solskinn og andre varmekilder. Ikke sett TV-mottakeren direkte på andre produkter som avgir varme, f.eks. videokassettspillere og lydforsterkere. Plasser ikke åpne flammekilder, sånn som lyste talglys, på TV-en.

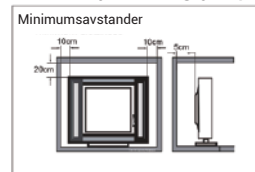

Hvis fjernsynet skal bygges inn i et rom eller lignende innkapsling, må minimumsavstandene opprettholdes. Varmeoppbygging kan redusere levetiden til TV-en din, og kan også være farlig.

Merk: bruk av apparater i moderat klima.

Forsiktig:

Et TV-apparat kan falle og forårsake alvorlige skader eller dødsfall. Mange skader, spesielt hos barn, kan unngås ved å ta enkle forholdsregler som:

- Bruk ALLTID kabinetter eller stativer eller monteringsmetoder anbefalt av produsenten av TV-en.
- Bruk ALLTID møbler som på en sikker måte kan holde vekten av TV-en.
- Pass ALLTID på at kanten av TV-en ikke kommer utenfor kanten til møbelet det står på.
- Fortell ALLTID barn om farene ved å klatre på møbler for å komme til TV-en eller kontrollene på den.
- Trekk ALLTID ledninger og kabler tilkoblet til TV-en slik at ingen snubler i dem, trekker i dem eller hekter seg i dem.
- Plasser ALDRI et TV-apparat på et ustabilt sted.
- Plasser ALDRI TV-en på høye møbler (som skap eller bokhyller) uten å feste både møbelet og TV-en på en egnet måte.
- Plasser ALDRI TV-en på en duk eller andre materialer som måtte befinne seg mellom TV-en og støttemøbelet.
- Plasser ALDRI gjenstander, som leker og fjernkontroller, som kan friste barn til å klatre opp på TV-en eller møbler som TV-en er plassert på.

Hvis din nåværende TV skal beholdes og flyttes, må samme hensyn som de ovenstående tas.

FORBEREDELSE

VIKTIG: Ikke bruk trykk på skjermens visningsområde da det kan redusere integriteten til skjermen. Produsentens garanti dekker ikke feil bruk fra brukerens side eller feilaktig montering.

FESTE STATIVET

VIKTIG: Stativet til TV-en må monteres før bruk.

1. Plasser TV-enheten med forsiden ned på en myk og flat overflate (teppe, skum, klut osv.) for å unngå skade på TV-en.
2. Fest stativet til bunnen av TV-en med de 6 skruene.

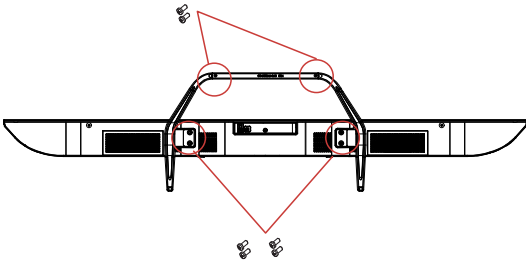

! MERK
Produktets utseende skal være av type.

KLARGJØRING AV LED-TV-EN DIN FOR VEGGMONTERING

Vi anbefaler at du har TV-en minst 60 mm fra veggen for å forhindre kabelinterferens. Før du monterer TV-en på veggen, må du ta av stativet.

For din egen sikkerhet må denne kun brukes med en UL-listet veggmonteringsbrakett med minimumsvekt på TV-en uten stativ.

Slik fester du en veggmonteringsbrakett til TV-en:

1. Skru ut skruene som holder TV-en til stativet.
2. Ta av stativet fra TV-en.
3. Fest veggfestebraketten på baksiden av TV-en med fire skruer. Følg instruksjonene i brukerhåndboken som fulgte med veggfestebraketten for å montere.

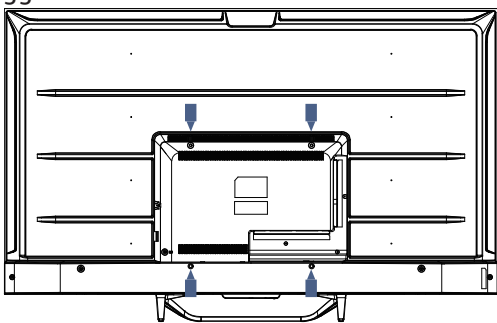

! MERK
Veggfestebraketten er ikke inkludert.

4. Fest veggmonteringsskruene (M6x12 mm / 4 stk) på baksiden av LED-TV-en, med et dreiemoment på 12 kgf,cm.

SLÅ PÅ TV-EN

1. Monter stativet og plasser TV-en på en hard overflate.

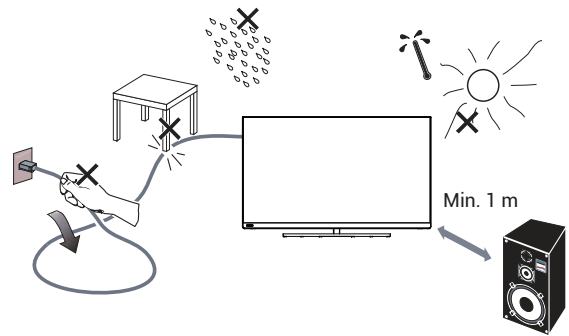

! MERK

- Sørg for at TV-en er plassert i en posisjon som muliggjør fri flyt av luft. Ikke dekk til ventilasjonsåpningene på bakdekselet.
 - For å unngå utrygge situasjoner bør ikke noen kilder med åpen flamme, for eksempel tente stearinlys, plasseres på eller i nærheten.
 - Unngå varme, direkte sollys og eksponering for regn eller vann. Apparatet må ikke bli utsatt for drypp eller sprut.
2. Koble antennekabelen eller kabel-TV-kabelen til **ANT IN**-antennekontakten på baksiden av TV-apparatet.
 3. Fjernkontroll:
Fjern dekslet over batteriholderen. Sett inn 2 batterier (Type AAA 1,5 V).

FORSIKTIG: Det finnes en risiko for branneeksplosjon hvis batteriet skiftes ut med et annet av feil type.

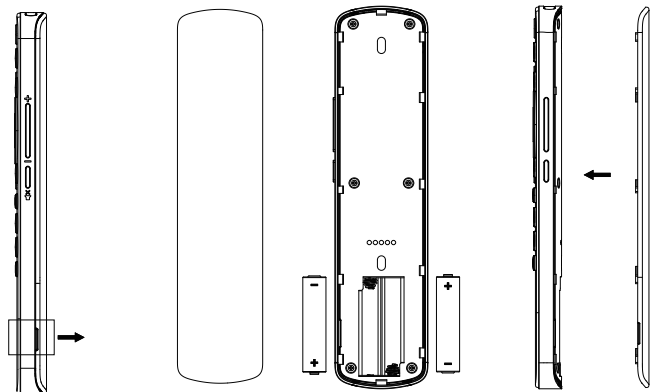

4. Strøm:
Plugg inn kabelen i en fungerende stikkontakt.

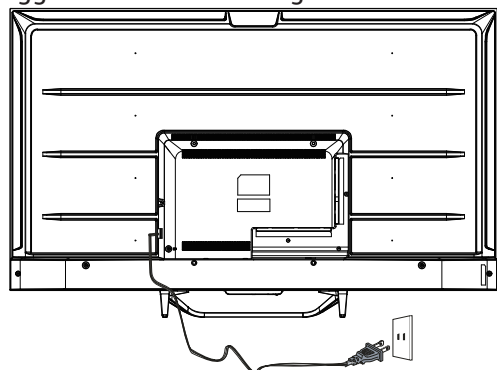

5. Slå på TV-en:
Trykk på  på fjernkontrollen eller **POWER**-knappen på sidekontrollpanelet på TV-en.

TILKOBLING AV PERIFERIUTSTYR OG KONTROLLER

KNAPPEKONTROLL

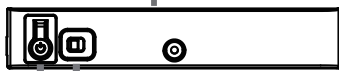
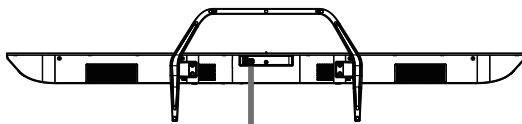
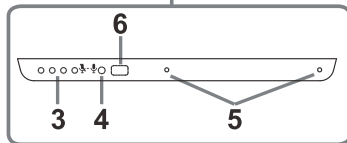
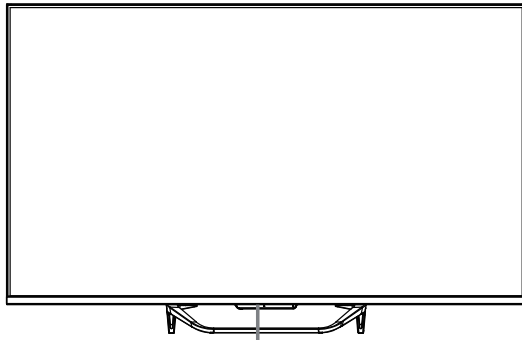

1. Slå på / slå av
2. Stemme på / stemme av
 - 🗨️ Aktiver Far Field-assistent
 - 🗨️ Deaktiver Far Field-assistent

Skru den til høyre for å slå den på. Indikatorlampen vil lyse og deretter slukke, stemmefunksjonen er initiert. du kan si «Ok Google» for å bruke stemmefunksjonen, så vil indikatoren lyse når TV-en mottar stemmen, så kan du si forespørselen din direkte.

Vri den til venstre for å slå den av for å avslutte stemmefunksjonen. Indikatorlyset vil bli gult.

3. Far Field-assistantens lys
4. Fjernkontrollsignalomtaker
5. Stemmesignalmottaker
6. Strømforsynings-LED

! MERK
Sørg for at TV-en er koblet til Internett før du bruker Voice.
Sett den til På før du bruker Voice.
Logg på GOOGLE-kontoen din før du bruker Voice.

TILBEHØR

- Fjernkontroll – 1 stk
- Brukerhåndbok – 1 stk
- Skruer – 6 stk
- Hurtigstartguide – 1 stk
- Garantikort – 1 stk

TILKOBLING AV PERIFERIUTSTYR



Alle terminalene er (fra venstre til høyre):
LAN, OPTISK, VIDEO, V, H, HDMI4, HDMI3, HDMI2,



Alle terminalene er (fra venstre til høyre):
HDMI1 (eARC/ARC), LNB IN (SATELLITT), ANT IN (ANTENNE/KABEL), USB1 , USB2, HODETELEFON, CI.

OPPRETT FORBINDELSER

AV-UTSTYR

Denne TV-en har én gruppe med AV for praktisk tilkobling til videospiller, DVD eller annet videoutstyr. Se også brukerhåndboken til utstyret som skal kobles til. Du kan bruke inngangsterminalene på TV-apparatets bakside som følger.

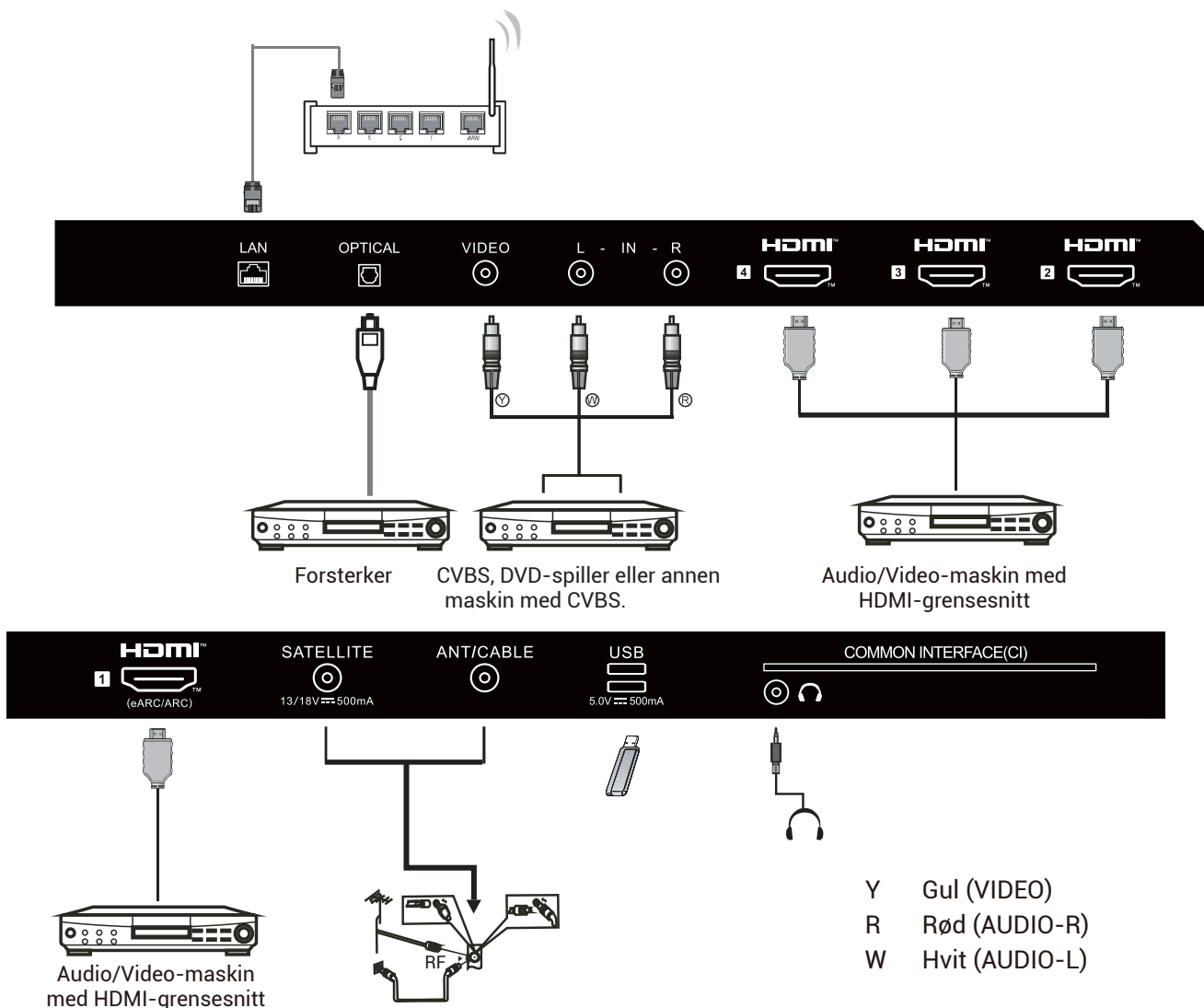

De kan kobles til følgende apparater: Videospiller, multi disc-spiller, DVD, videokamera, spillkonsoll eller stereoanlegg, osv.

Merk:

Noen ganger vil den ikke støtte annen enhet fordi enheten leverer et ikke-standard signal.

BRUKSINSTRUKSJONER

BRUKE FJERNKONTROLLEN

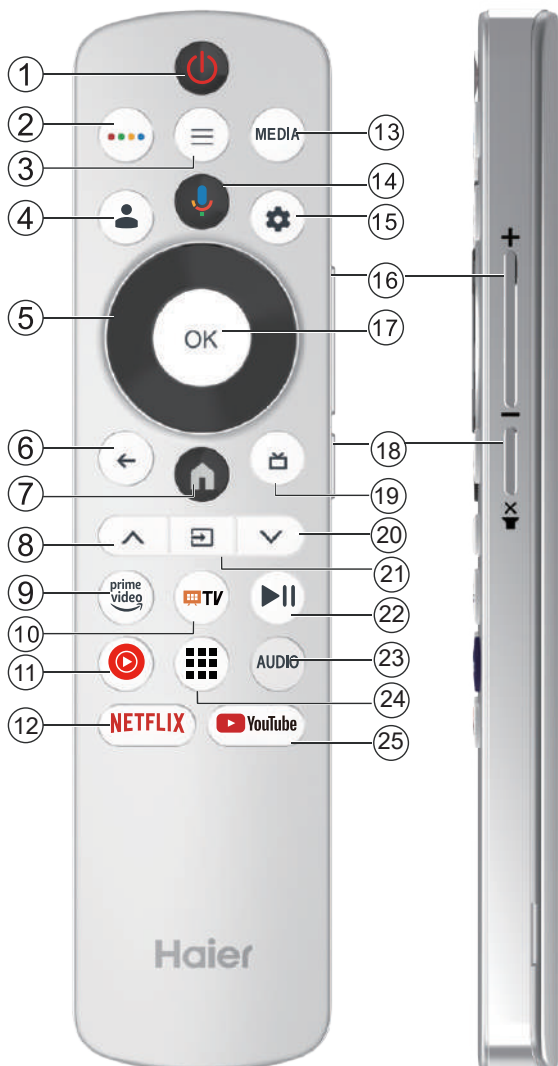

#	Element	Beskrivelser
1	Power	Trykk eller for å slå TV-en på eller av. Når TV-en er av, er det fortsatt strøm i den. For å koble TV-en helt fra strømmen, må du koble fra strømledningen
2		Trykk for å åpne MAGIC BOARD.
3		Trykk for å åpne eller lukke skjermmenyen.
4		Trykk for å gå til Kontoer og pålogging på Google TV. (Når du setter opp grunnleggende TV, har ikke denne tasten noen effekt)
5		For å gå ut av skjermmenyen.
6		Går tilbake til den forrige menyen.
7		Trykk for å åpne Hjem-siden.
8		Trykk for å bytte TV-kanal.
9		Trykk for å gå til prime video, for å se TV-serier og filmer på nett (internettilkobling kreves).
10		Trykk for å åpne Live TV.
11		Trykk for å åpne YouTube Music.
12		Trykk for å åpne NETFLIX.
13		Trykk for å åpne multimediaspiller.
14		Trykk for å åpne Google Assistant eller starte talesøk.
15		Trykk for å åpne innstillingsmenyen.
16	VOL+VOL-	Trykk på VOL+ eller VOL- for å justere volumnivået.
17	OK	Angi det valgte alternativet eller utfør den valgte handlingen.
18		For å dempe og oppheve demping av lyden.
19		Trykk for å vise elektronisk programguide i TV-modus.
20		Trykk for å bytte TV-kanal.
21		Trykk for å åpne inndatakilde listen.
22		Trykk for å spille av/pause i multimediemodus.
23	AUDIO	Trykk for å bytte lydspor.
24		Trykk for å åpne appene.
25		Trykk for å åpne YouTube.

BRUKSINSTRUKSJONER

FØRSTE INNSTILLING

Første gang du slår på TV-en, vil oppsettsveiviseren veilede deg gjennom å sette opp grunnleggende innstillinger.

Vennligst i henhold til teksttips til førstegangsoppsett.



Denne funksjonen brukes for fjernkontrollens parkode. Etter at koden er vellykket, kan du bruke Bluetooth-fjernkontrollen til å betjene TV-en.

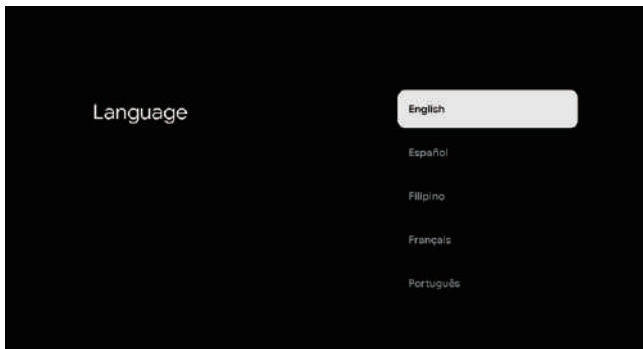

Trykk ▲/▼ for å velge systemspråk og trykk OK for å bekrefte språket.

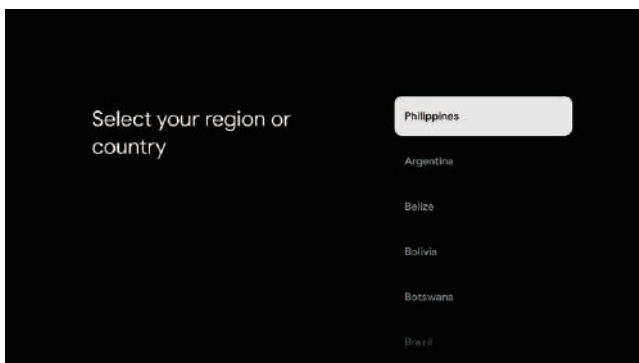

Trykk ▲/▼ for å velge land/region, og trykk på OK for å bekrefte.

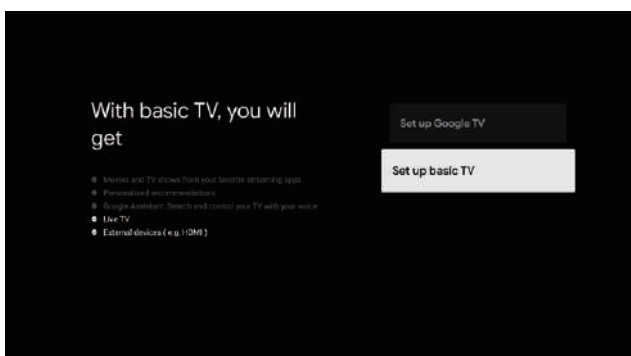

Trykk på ▲/▼ for å velge «Set up basic TV» (Konfigurer grunnleggende TV) for enheten, og trykk OK for å fullføre oppsettet.

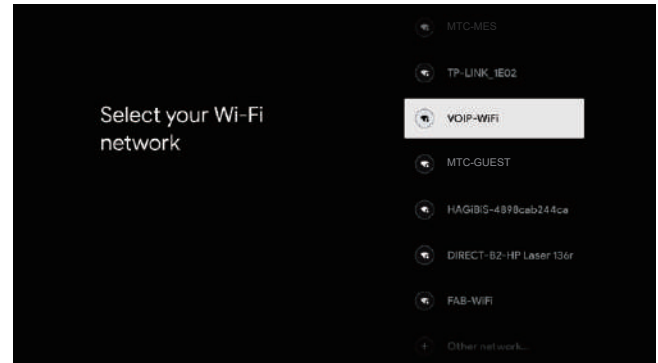

Trykk ▲/▼ for å velge wifi som skal kobles til, trykk OK og skriv inn passordet for å bekrefte at tilkoblingen er vellykket.

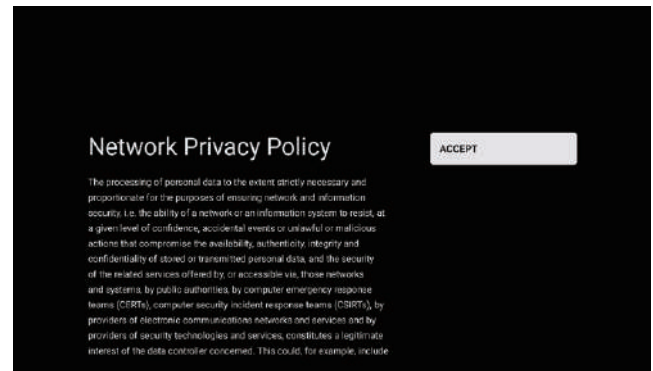

Velg «Accept» (Godta) for å godta disse vilkårene i Nettverkets retningslinjer for personvern.

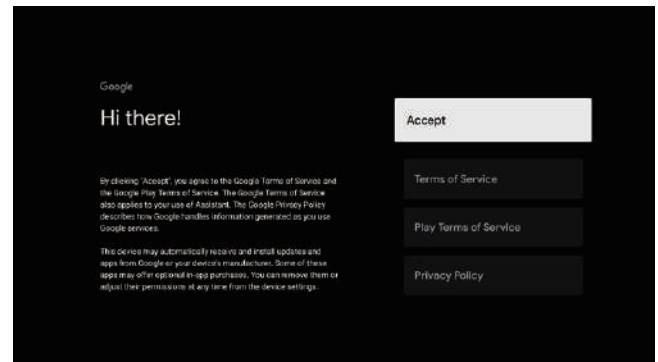

Godta Googles vilkår for bruk for å forbedre produktopplevelsen ved å velge «Accept» (Godta).

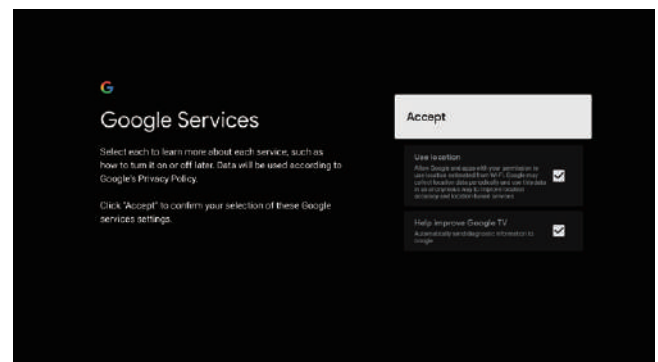

BRUKSINSTRUKSJONER

Godta Google Services for å forbedre produktopplevelsen ved å velge «Accept» (Godta).



Brukes til å angi enhetens passord for å besørge sikkerhet og personvern.

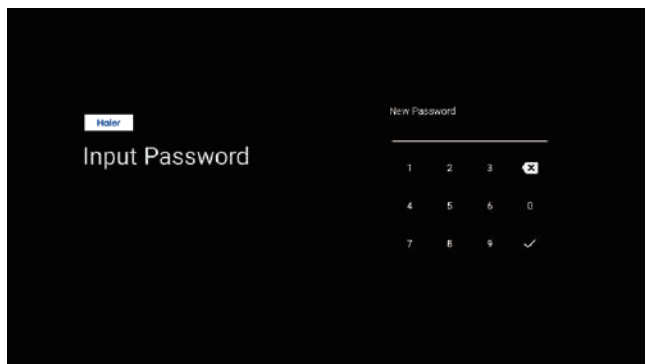

Bruk fjernkontrollen / skjermtastaturet til å skrive inn det 4-sifrede passordet for automatisk å hoppe til neste grensesnitt.

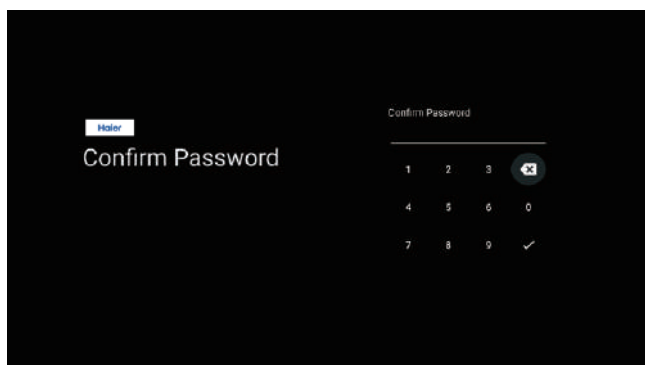

Bekreft passordet på nytt og sørg for at det er identisk. Bruk fjernkontrollen/skjermtastaturet til å skrive inn passordet og fullføre passordet.

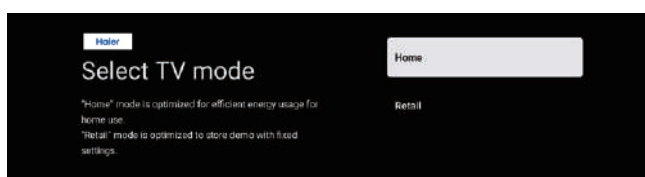

For å velge modus, trykk ▲/▼-tasten for å velge Hjem-modus og trykk OK.

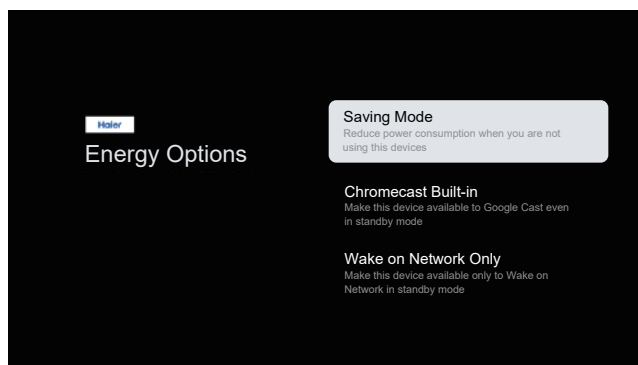

Velg «Saving Mode» (Lagremodus) og fortsett til neste trinn.

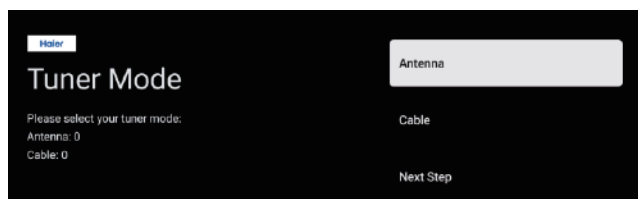

Velg Tuner-modus for søking, trykk for å velge og trykk OK for å bekrefte.

BRUKSINSTRUKSJONER

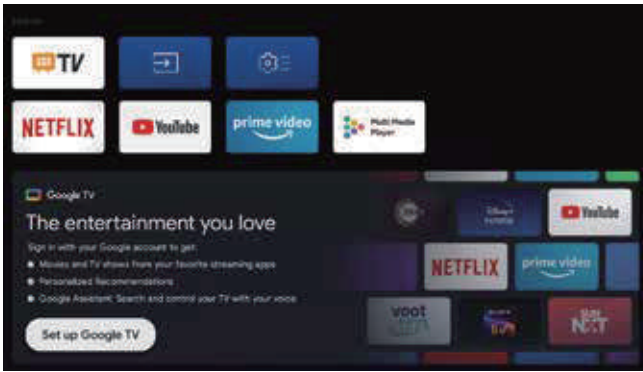

- Når du er i brukergrensesnittet, kan du bytte fra grunnleggende TV-innstillinger til Google TV-innstillinger.

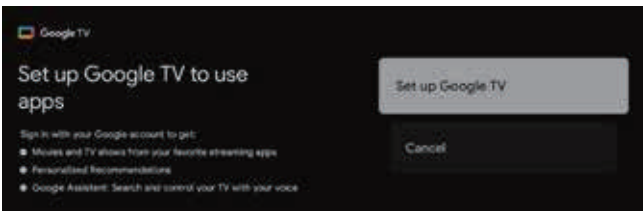

Trykk på ▲/▼ for å velge «Set up Google TV» (Konfigurer Google TV) på enheten og trykk OK for å fullføre oppsettet.

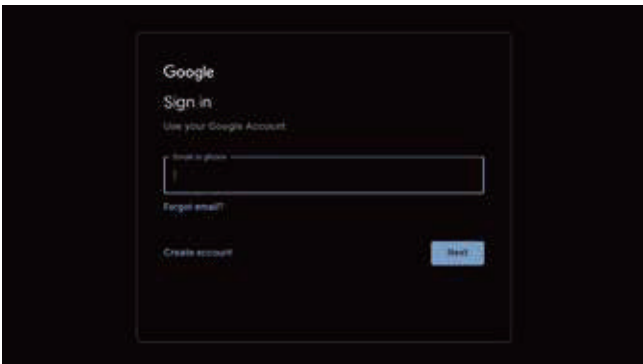

Bruk pålogging med Google-konto

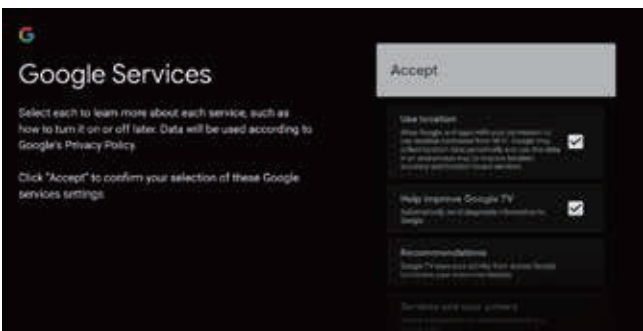
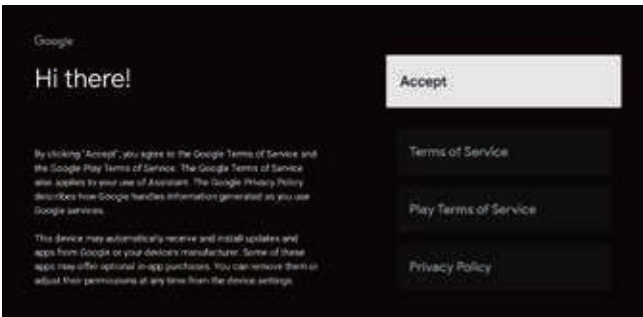

Godta Googles vilkår for bruk for å forbedre produktopplevelsen ved å velge «Accept» (Godta).

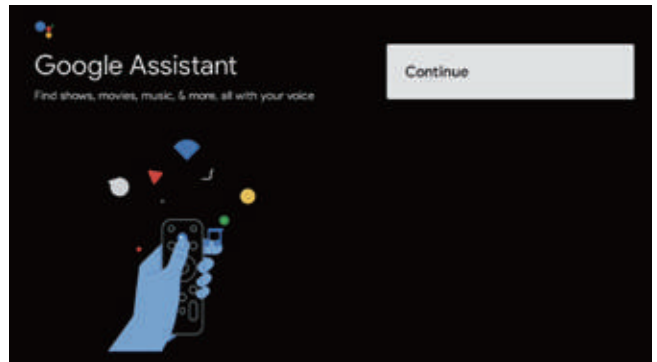

Trykk for å velge, og trykk deretter på OK for å fortsette.

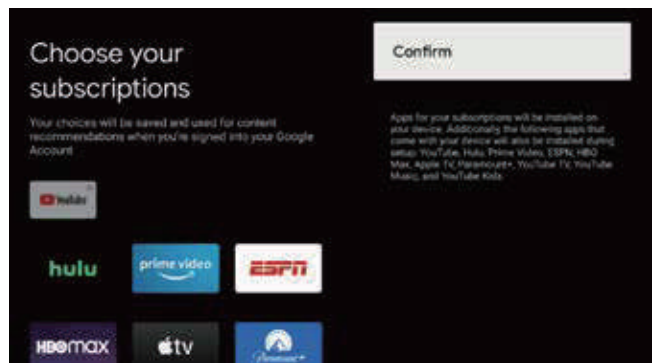

Trykk på ▲/▼ for å velge Velg dine abonnementer og trykk OK.

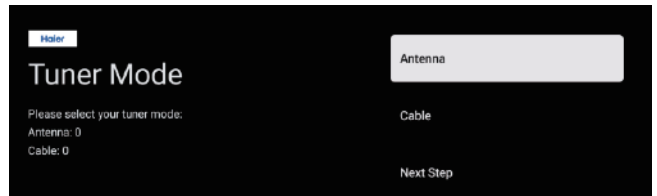

BRUKSINSTRUKSJONER

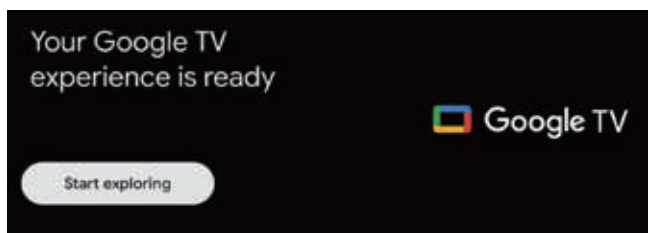

Google TV-opplevelsen din er klar, og trykk OK for å begynne å utforske.

HJEMSKJERM

Etter å ha fullført innstillingene i veiviseren, kan du se på TV og gå til startskjermen.

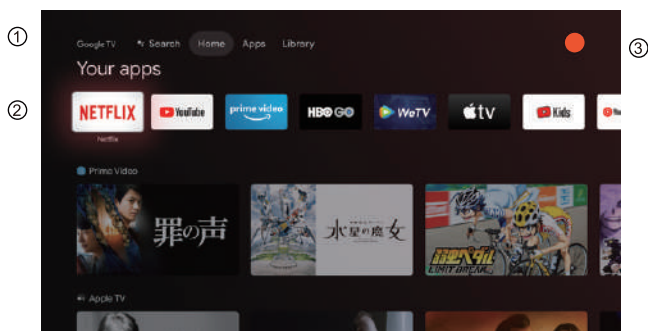

- ① **Search** Åpne Google-assistenten eller start et talesøk.
Home Åpne TV-hjemmesiden din.
Apps Åpne listen over apper du har installert og legg til favorittappene dine.
Library Se innholdet som er kjøpt og leid under brukerkontoen.
- ② En liste over applikasjoner og push-innhold du har installert.
- ③ Åpne kontoinformasjon, innstillinger, tid, innganger og bilde.
Innstillinger: Ulike innstillinger kan konfigureres her. Detaljer om innstillingene kommer i neste forklaring.
Innganger: Ikon for å velge inngangskilde.
Bilde: Brukeren kan stille inn TV-bildet. Se side 12 for detaljerte instruksjoner om oppsett.

NAVIGERING AV SKJERMMENYEN

Det er to måter å gå inn på. Først, i direkte TV, trykk på menyknappen for å vise TV-alternativer, trykk **▲/▼/◀/▶** for å velge innstillingsmenyen og trykk **OK** for å bekrefte. For det andre, i HJEM-grensesnittet, trykker du **▶**-knappen for å velge ikonet for -menyen, trykk **OK** for å bekrefte.

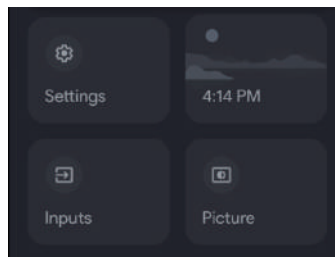
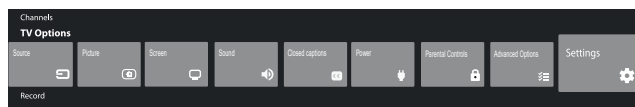

Trykk på **▲/▼**-knappen for å velge hva du vil angi. Trykk **OK** for å gå inn i innstillinger.

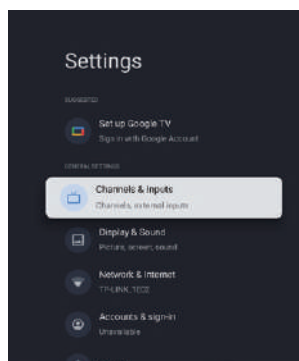

Trykk på **TILBAKE** for å gå tilbake til forrige meny. Hvis hovedmenyen vises, vil et trykk på **TILBAKE** lukke skjermmenyen.

BRUKSINSTRUKSJONER

KANALER

Menu -> Settings -> Channels & Inputs -> Channels (Meny -> Innstillinger -> Kanaler og innganger -> Kanaler).

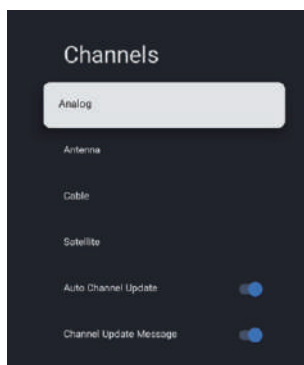

Analog/Antenna/Cable/Satellite (Analog/Antenne/Kabel/Satellitt) - Trykk på ▲/▼ knappen for å velge alternativet, og trykk deretter på OK for å gå inn i undermenyen.

Auto Channel Update (Automatisk oppdatering av kanaler) - Trykk på OK-knappen for å velge mellom ON/OFF (PÅ/AV). Hvis du velger ON (PÅ), vil systemet automatisk skanne og oppdatere kanalene etter en standby-tid på 5 minutter.

Channel Update Message (Melding for oppdatering av kanaler) - Trykk på Ok-knappen for å velge mellom ON/OFF (PÅ/AV). Hvis du velger ON (PÅ), vil systemet vise deg meldingen for oppdateringen.

MERK: Hvilken kilde som er tilgjengelig, avhenger av modellen.

INPUTS (INNGANGER)

Meny -> Innstillinger -> Kanaler og innganger -> Innganger

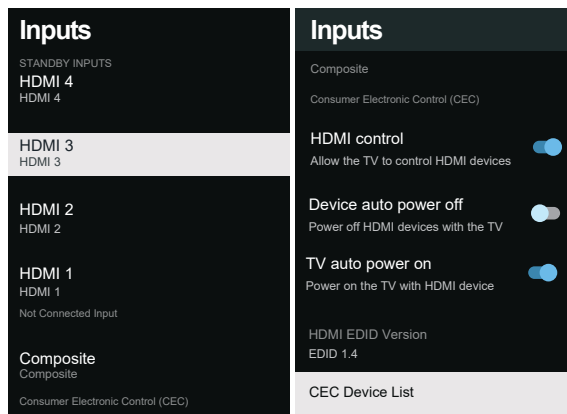

Inputs (Innganger) – trykk på ▲/▼-knappen for å velge alternativet, og trykk deretter på OK-knappen for å gå inn i undermenyen.

HDMI control (HDMI-kontroll) – trykk på ▲/▼-knappen for å velge alternativet, og trykk deretter på OK-knappen for å velge PÅ/AV.

Device auto power off (Automatisk avslåing av enheten) – trykk på ▲/▼-knappen for å velge alternativet, og trykk deretter på OK-knappen for å velge ON/OFF (PÅ/AV).

TV auto power on (TV-automatisk på) – trykk på ▲/▼-knappen for å velge alternativet, og trykk deretter på OK-knappen for å velge ON/OFF (PÅ/AV).

HDMI EDID Version (HDMI EDID-versjon) – vis EDID-versjon.

CEC Device List (CEC Device-enhetsliste) – trykk på ▲/▼-knappen for å velge alternativet og trykk deretter OK-knappen for å gå inn i undermenyen.

DISPLAY OG LYD

Meny -> Innstillinger -> Skjerm og lyd

I denne menyen kan du stille inn bildet og lyden til TV-en.

1. Trykk på ▲/▼-knappen for å velge hva du vil angi.
2. Trykk knappen OK for å
3. Etter å ha fullført justeringen, trykker du på BACK-knappen for å gå tilbake til forrige meny.

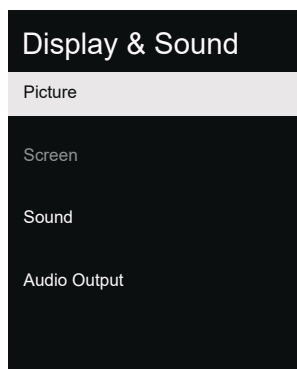

BRUKSINSTRUKSJONER

PICTURE (BILDE)

Meny -> Innstillinger -> Skjerm og lyd -> Bilde.

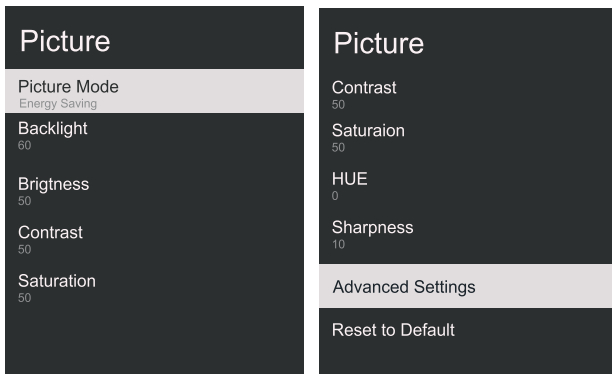

Picture Mode (Bildemodus) – trykk på ▲/▼-knappen for å velge alternativet og trykk deretter OK-knappen for å gå inn i undermenyen.

(Valgfritt: Bruker, Standard, Livlig, Sport, Film, Spill, Energisparing).

Backlight/Brightness/Contrast/Saturation/HUE/Sharpness (Bakgrunnslys/Lysstyrke/Kontrast/Metning/Fargetone/Skarphet) – trykk ▲/▼-knappen for å velge alternativet og trykk deretter OK-knappen for å gå inn.

Trykk på ◀ for å redusere parameteren. Trykk på ▶ for å øke parameteren.

Advanced Settings (Avanserte innstillinger) – trykk på ▲/▼-knappen for å velge alternativet, og trykk deretter på OK-knappen for å gå inn i undermenyen.

Reset to Default (Nullstill til standard) – nullstill alle innstillinger til fabrikkstandard.

SOUND

Meny -> Innstillinger -> Skjerm og lyd -> Lyd.

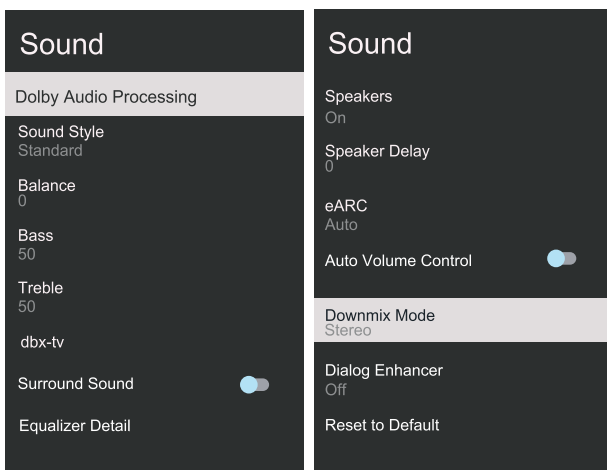

Dolby Audio processing (Dolby Audio-prosessering) – trykk på ▲/▼-knappen for å velge alternativet og trykk deretter OK-knappen for å gå inn i undermenyen.

Sound style (Lydstil) – trykk på ▲/▼-knappen for å velge alternativet, og trykk deretter på OK-knappen for å gå inn i undermenyen.

(Valgfritt: Bruker, Standard, Natt, Sport, Film, Musikk, Nyheter).

Balance/Bass/Treble (Balanse/bass/diskant) – trykk ▲/▼-knappen for å velge alternativet og trykk deretter OK-knappen for å gå inn.

Trykk på ◀ for å redusere parameteren.

Trykk på ▶ for å øke parameteren.

dbx-tv – trykk på ▲/▼-knappen for å velge alternativet, og trykk deretter på OK-knappen for å gå inn i undermenyen.

Surround Sound (Surroundlyd) – trykk på ▲/▼-knappen for å velge alternativet, og trykk deretter på OK-knappen for å velge PÅ/AV.

Equalizer Detail (Equalizer-detalj) – trykk på ▲/▼-knappen for å velge alternativet, og trykk deretter på OK-knappen for å gå inn i undermenyen.

Speakers (Høytalere) – trykk på ▲/▼-knappen for å velge alternativet, og trykk deretter på OK-knappen for å velge PÅ/AV.

Speaker Delay (Høytalerforsinkelse) – trykk ▲/▼-knappen for å velge alternativet og trykk deretter OK-knappen for å gå inn.

Trykk på ◀ for å redusere parameteren. Trykk på ▶ for å øke parameteren.

eARC – trykk på ▲/▼-knappen for å velge alternativet, og trykk deretter på OK-knappen for å velge PÅ/AV.

Auto Volume Control (Automatisk volumkontroll) – trykk på ▲/▼-knappen for å velge alternativet, og trykk deretter på OK-knappen for å velge PÅ/AV.

Downmix Mode (Nedmiksmodus) – trykk på ▲/▼-knappen for å velge alternativet, og trykk deretter på OK-knappen for å gå inn i undermenyen. (Valgfritt: Stereo, Surround).

Dialog Enhancer (Dialogforsterker) – trykk på ▲/▼-knappen for å velge alternativet, og trykk deretter på OK-knappen for å gå inn i undermenyen. (Valgfritt: Av, Lav, Medium og Høy).

Reset to Default (Nullstill til standard) – nullstill alle innstillinger til fabrikkstandard.

AUDIO OUTPUT (LYDUTGANG)

Meny -> Innstillinger -> Skjerm og lyd -> Lydutgang.

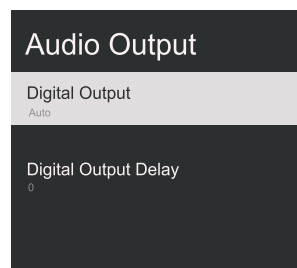

Digital Output (Digital utgang) – trykk på ▲/▼-knappen for å velge alternativet, og trykk deretter på OK-knappen for å gå inn i undermenyen. (Valgfritt: Auto, Bypass, PCM, Dolby Digital Plus og Dolby Audio-Dolby Digital).

Digital Output Delay (Digital utgangsforsinkelse) – trykk ▲/▼-knappen for å velge alternativet og trykk deretter OK-knappen for å gå inn.

Trykk på ◀ for å redusere parameteren.

Trykk på ▶ for å øke parameteren.

BRUKSINSTRUKSJONER

NETWORK (NETTVERK)

Meny -> Innstillinger -> Nettverk og Internett

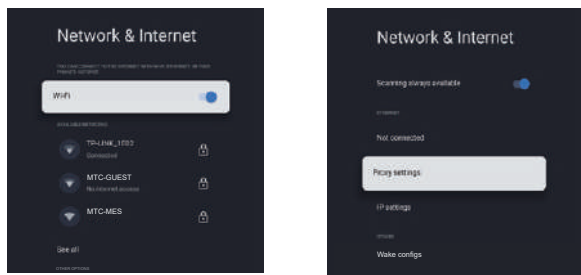

1. Trykk på ▲/▼-knappen for å velge hva du vil angi.
2. Trykk på OK-knappen for å bekrefte.
3. Etter å ha fullført justeringen, trykker du på OK-knappen for å lagre og gå tilbake til forrige meny.

ACCOUNTS & SIGN IN (KONTOER OG PÅLOGGING)

1. Meny -> Innstillinger -> Kontoer og pålogging.
2. I HJEM-grensesnittet trykker du på ▲/▼-knappen for å velge «Set up Google TV» (Konfigurer Google TV) og fortsetter til neste trinn.

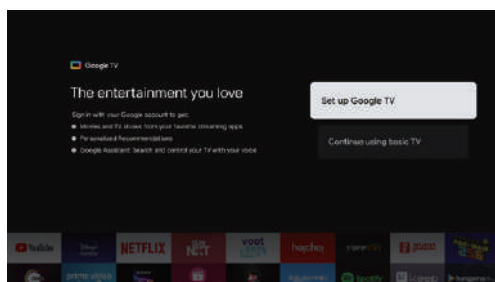

Velg «Set up Google TV» (Konfigurer Google TV) og fortsett til neste trinn, skriv inn kontoen din og passordet ditt. Og følg instruksjonene for å fullføre de relevante innstillingene.

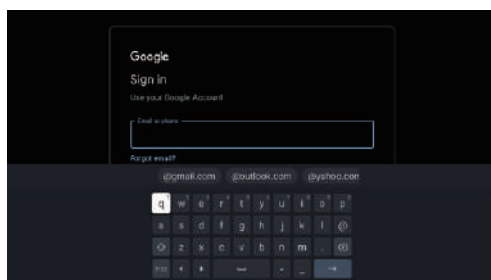

PRIVACY (PERSONVERN)

Meny -> Innstillinger -> Personvern.

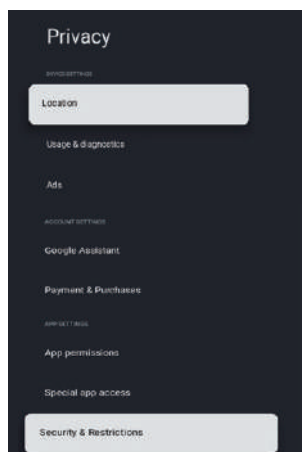

I denne menyen kan du stille inn plassering, bruk og diagnostikk osv. for TV-en.

1. Trykk på ▲/▼-knappen for å velge hva du vil angi.
2. Trykk på OK-knappen for å bekrefte.
3. Etter å ha fullført justeringen, trykker du på BACK-knappen for å gå tilbake til forrige meny.

LOCATION (PLASSERING)

Meny -> Innstillinger -> Personvern -> Plassering.

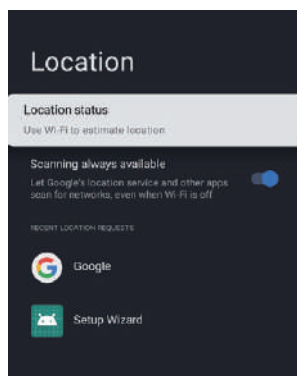

Location status (Plasseringsstatus) – trykk på ▲/▼-knappen for å velge alternativet, og trykk deretter på OK-knappen for å gå inn i undermenyen. (Valgfritt: Bruk Wi-Fi for å beregne plassering, av)

Scanning always available (Skanning alltid tilgjengelig) – trykk på ▲/▼-knappen for å velge alternativet, og trykk deretter på OK-knappen for å velge PÅ/AV.

USAGE & DIAGNOSTICS (BRUK OG DIAGNOSTIKK)

Meny -> Innstillinger -> Personvern -> Bruk og diagnostikk

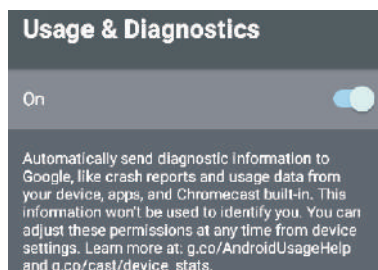

BRUKSINSTRUKSJONER

Usage & diagnostics (Bruk og diagnostikk) – trykk på ▲/▼-knappen for å velge alternativet, og trykk deretter på OK-knappen for å velge PÅ/AV.

APPS (APPER)

Meny -> Innstillinger -> Apper.

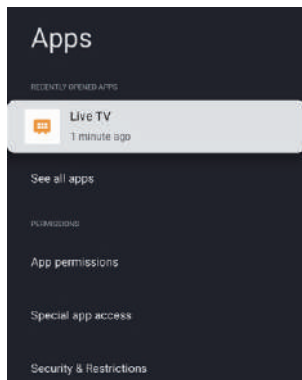

I denne menyen kan du angi APP-tillatelsene og lese applistene

1. Trykk på ▲/▼-knappen for å velge hva du vil angi.
2. Trykk på OK-knappen for å bekrefte.
3. Etter å ha fullført justeringen, trykker du på BACK-knappen for å gå tilbake til forrige meny.

SYSTEM

Meny -> Innstillinger -> System.

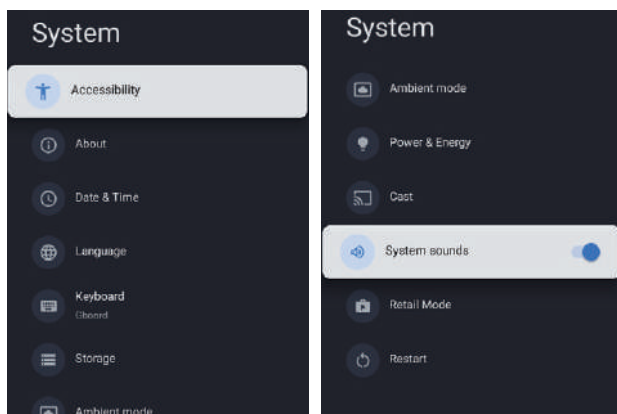

I denne menyen kan du lese informasjonen og innstillingene til TV-en.

1. Trykk på ▲/▼-knappen for å velge hva du vil angi.
2. Trykk på OK-knappen for å bekrefte.
3. Etter å ha fullført justeringen, trykker du på BACK-knappen for å gå tilbake til forrige meny.

System sounds (Systemlyder) – trykk på ▲/▼-knappen for å velge alternativet, og trykk deretter på OK-knappen for å velge PÅ/AV. Detaljer om systemet kommer i neste forklaring.

ACCESSIBILITY (TILGJENGELIGHET)

Meny -> Innstillinger -> System -> Tilgjengelighet.

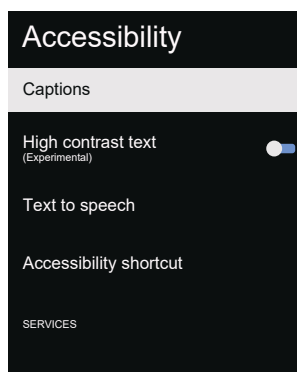

Captions (Bildetekst) – trykk på ▲/▼-knappen for å velge alternativet, og trykk deretter på OK-knappen for å gå inn i undermenyen.

High contrast text (Tekst med høy kontrast) – trykk på ▲/▼-knappen for å velge alternativet, og trykk deretter på OK-knappen for å velge PÅ/AV.

Text to speech (Tekst til tale) – trykk på ▲/▼-knappen for å velge alternativet, og trykk deretter på OK-knappen for å gå inn i undermenyen.

Accessibility shortcut (Tilgjengelighetssnarvei) – trykk på ▲/▼-knappen for å velge alternativet, og trykk deretter på OK-knappen for å gå inn i undermenyen.

ABOUT (OM)

Meny -> Innstillinger -> System -> Om.

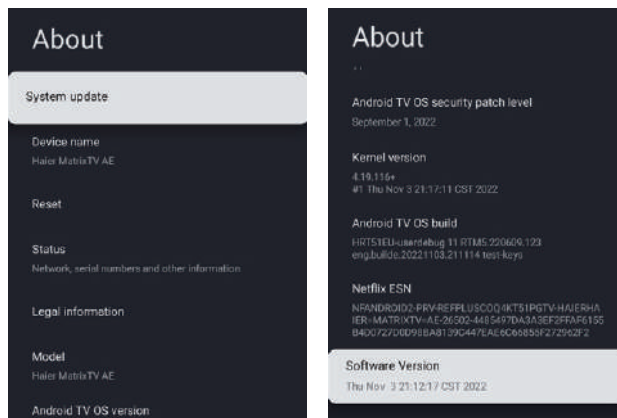

I denne menyen kan du oppdatere eller tilbake stille systemet, samt lese informasjonen til TV-en.

1. Trykk på ▲/▼-knappen for å velge hva du vil angi.
2. Trykk på OK-knappen for å bekrefte.
3. Etter å ha fullført justeringen, trykker du på BACK-knappen for å gå tilbake til forrige meny.

DATE & TIME (DATO OG TID)

Meny -> Innstillinger -> System -> Dato og tid.

BRUKSINSTRUKSJONER

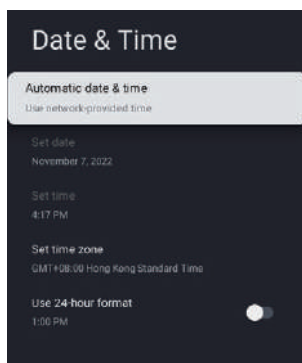

Automatic date & time (Automatisk dato og klokkeslett) – trykk på ▲/▼-knappen for å velge alternativet og trykk deretter **OK**-knappen for å gå inn i undermenyen.
(Valgfritt: Bruk nettverkslevert tid, av)

MERK

- Hvis du har satt Automatic date & time (Automatisk dato/tid) på OFF (AV), kan du stille dato & tid manuelt.

Set date (Stille inn dato) – trykk på ▲/▼-knappen for å velge alternativet og trykk deretter **OK**-knappen for å gå inn i undermenyen.

Set time (Stille inn tid) – trykk på ▲/▼-knappen for å velge alternativet og trykk deretter **OK**-knappen for å gå inn i undermenyen.

Set time zone (Stille inn tidssone) – trykk på ▲/▼-knappen for å velge alternativet og trykk deretter **OK**-knappen for å gå inn i undermenyen.

Use 24-hour format (Bruk 24-timers format) – trykk på ▲/▼-knappen for å velge alternativet, og trykk deretter på **OK**-knappen for å velge PÅ/AV.

LANGUAGE (SPRÅK)

Meny -> Innstillinger -> System -> Språk.

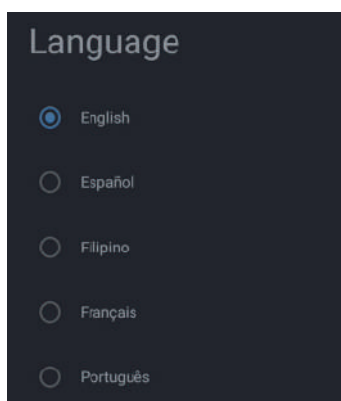

Language (Språk) – trykk på ▲/▼-knappen for å velge alternativet, og trykk deretter på **OK**-knappen for å gå inn i valgt språk.

KEYBOARD (TASTATUR)

Meny -> Innstillinger -> System -> Tastatur.

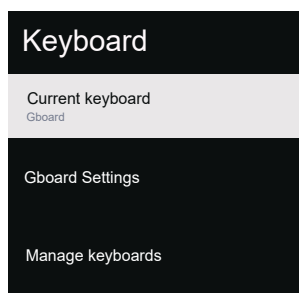

Current keyboard (Gjeldende tastatur) – trykk på ▲/▼-knappen for å velge alternativet og trykk deretter **OK**-knappen for å gå inn i undermenyen.
Gboard Settings (Gboard-innstillinger) – trykk på ▲/▼-knappen for å velge alternativet, og trykk deretter på **OK**-knappen for å gå inn i undermenyen.
Manage keyboards (Administrer tastaturer) – trykk på ▲/▼-knappen for å velge alternativet og trykk deretter **OK**-knappen for å gå inn i undermenyen.

STORAGE (LAGRING)

Meny -> Innstillinger -> System -> Lagring.

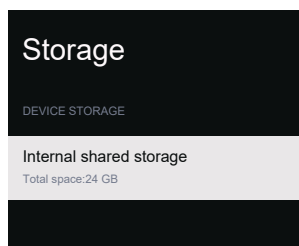

Internal shared storage (Intern delt lagring) – trykk på ▲/▼-knappen for å velge alternativet og trykk deretter **OK**-knappen for å gå inn i undermenyen.

AMBIENT MODE (AMBIENTMODUS)

Meny -> Innstillinger -> System -> Ambientmodus.

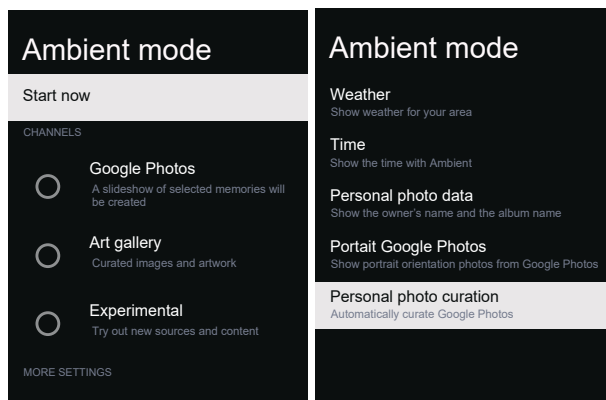

I denne menyen kan du stille inn ambientmodus.

1. Trykk på ▲/▼-knappen for å velge hva du vil angi.
2. Trykk på **OK**-knappen for å bekrefte.
3. Etter å ha fullført justeringen, trykker du på **BACK**-knappen for å gå tilbake til forrige meny.

BRUKSINSTRUKSJONER

STRØM OG ENERGI

Meny -> Innstillinger -> System -> Strøm og energi.

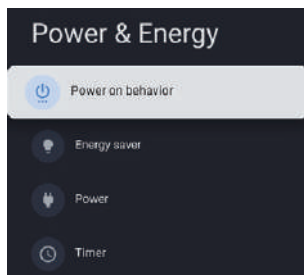

I denne menyen kan du stille inn strøm og energi. (strøm på-atferd, energisparing, strøm og tidtaker)

1. Trykk på ▲/▼-knappen for å velge hva du vil angi.
2. Trykk på **OK**-knappen for å bekrefte.
3. Etter å ha fullført justeringen, trykker du på **BACK**-knappen for å gå tilbake til forrige meny.

POWER ON BEHAVIOR (STRØM PÅ-ATFERD)

Meny -> Innstillinger -> System -> Strøm og energi -> Slå på atferd.

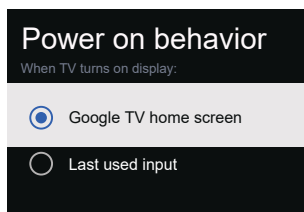

Trykk ▲/▼-knappen for å velge mappen du ønsker, og trykk **OK**-knappen for å bekrefte.

ENERGY SAVER (ENERGISPARER)

Meny -> Innstillinger -> System -> Strøm og energi -> Energisparer.

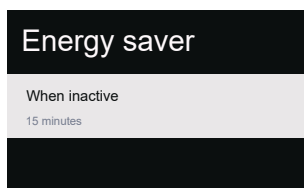

When inactive (Når inaktiv) – trykk på ▲/▼-knappen for å velge alternativet og trykk deretter **OK**-knappen for å gå inn i undermenyen.

(Valgfritt: 15 minutter, 20 minutter, 30 minutter, 1 time, 4 timer, 8 timer, 12 timer, 24 timer, Aldri).

POWER (EFFEKT)

Meny -> Innstillinger -> System -> Strøm og energi -> Strøm.

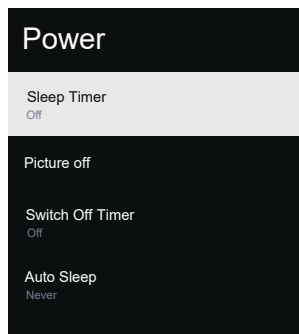

Sleep Timer (Innsøvningstimer) – trykk på ▲/▼-knappen for å velge alternativet og trykk deretter **OK**-knappen for å gå inn i undermenyen. (Valgfritt: av, 10 minutter, 20 minutter, 30 minutter, 40 minutter, 50 minutter, 60 minutter, 90 minutter, 120 minutter)

Picture off (Bilde av) – trykk ▲/▼-knappen for å velge alternativet og trykk deretter **OK**-knappen for å gå inn.

Switch off timer (Avslåingstimer) – trykk på ▲/▼-knappen for å velge alternativet og trykk deretter **OK**-knappen for å gå inn i undermenyen. (Valgfritt: av, 30 minutter, 60 minutter, 90 minutter, 120 minutter, 150 minutter, 180 minutter, 210 minutter, 240 minutter)

Auto sleep (Automatisk innsøvning) – trykk på ▲/▼-knappen for å velge alternativet og trykk deretter **OK**-knappen for å gå inn i undermenyen. (Valgfritt: Aldri, 4 timer, 6 timer, 8 timer)

TIMER (TIDTAKER)

Meny -> Innstillinger -> System -> Strøm og energi -> Timer.

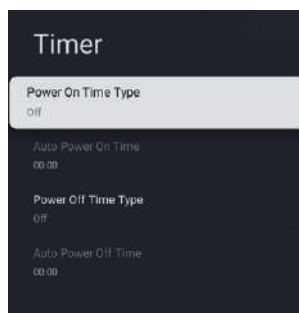

Power On Time Type (Tidstype for strøm på) – trykk på ▲/▼-knappen for å velge alternativet, og trykk deretter på **OK**-knappen for å velge AV / PÅ / ÉN GANG.

Auto Power On Time (Automatisk påslåingstid) – trykk på ▲/▼-knappen for å velge alternativet og trykk deretter **OK**-knappen for å gå inn i undermenyen.

Power Off Time Type (Tidstype for strøm av) – trykk på ▲/▼-knappen for å velge alternativet, og trykk deretter på **OK**-knappen for å velge AV / PÅ / ÉN GANG.

Auto Power Off Time (Automatisk avslåingstid) – trykk på ▲/▼-knappen for å velge alternativet og trykk deretter **OK**-knappen for å gå inn i undermenyen.

BRUKSINSTRUKSJONER

CAST

Meny -> Innstillinger -> System -> Cast.

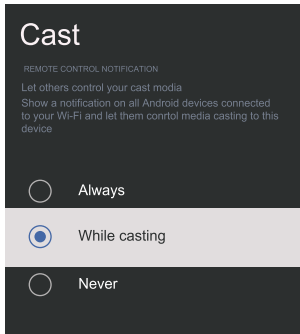

1. Trykk på ▲/▼-knappen for å velge hva du vil angi.
2. Trykk på OK-knappen for å bekrefte.
3. Trykk på -knappen for å gå tilbake til forrige meny.

RETAIL MODE (FORHANDLERMODUS)

Meny -> Innstillinger -> System -> Forhandlermodus.

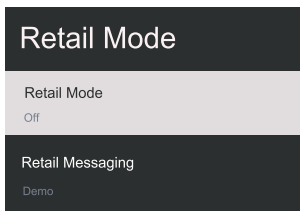

Retail mode (Forhandlermodus) – trykk på ▲/▼-knappen for å velge alternativet, og trykk deretter på OK-knappen for å velge PÅ/AV.

Retail messaging (Forhandlermeldinger) – trykk på ▲/▼-knappen for å velge alternativet og trykk deretter OK-knappen for å gå inn i undermenyen. (Merk: Demo, e-POP, e-POP + demo)

RESTART (OMSTART)

Meny -> Innstillinger -> System -> Start på nytt. Trykk på OK-knappen for å gå inn i undermenyen. (Valgfritt: start på nytt og avbryt)

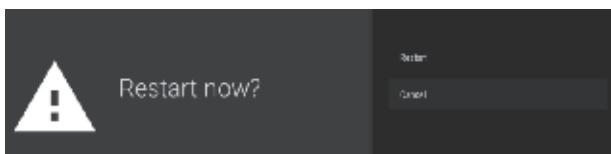

REMOTE & ACCESSORIES (FJERNKONTROLLER OG TILBEHØR)

Meny -> Innstillinger -> Fjernkontroller og tilbehør.

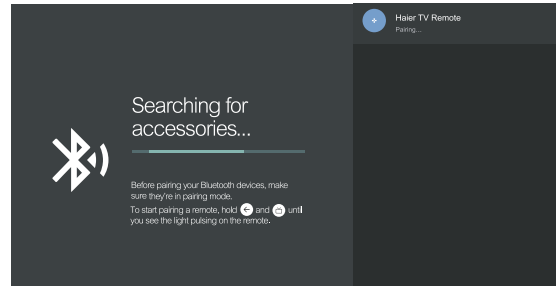
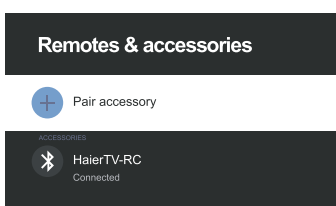

I denne menyen kan du pare Bluetooth-enheter.

1. Trykk på knappene «←» og «→» nederst på fjernkontrollen i 5 sekunder.
2. Når dioden begynner å blinke, slipper du den opp. Fjernkontrollen sender paringssignalet til TV-en og viser informasjonen til fjernkontrollen på høyre side av skjermen.
3. Trykk på OK-knappen for å vise paringen. Hvis den parede vises, er tilkoblingen vellykket.
4. Hvis den parede ikke vises, mislykkes tilkoblingen. Vent 30 sekunder og trykk deretter på knappene «←» og «→» nederst på fjernkontrollen i 5 sekunder for å gjenta de foregående trinnene.
5. Trykk «←»-knappen for å gå tilbake til den forrige menyen.

BRUK AV MULTIMEDIASPILLEREN

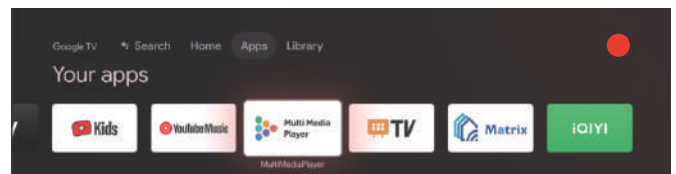

1. I HJEM- eller APPS-grensesnittet trykker du ▲/▼//◀/▶ for å velge multimediaspiller-applikasjonen

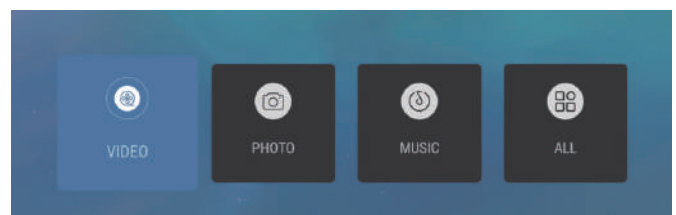

2. Velg OK-tasten for å gå inn i multimediaspilleren og vise Video, Bilde, Lyd. Etter at du har satt inn usb-minnet, kan du se de tilsvarende filene i usb-minnet (FAT32-format).

MERK

Menyen kan være annerledes, avhengig av når du kjøpte TV-en.

FEILSØKING

Utfør disse enkle sjekkene før du ringer service. Disse tipsene kan spare deg for tid og penger siden gebyrer for mottakerinstallasjon og justeringer av kundekontroller ikke dekkes av garantien.

Symptomer	Elementer som må sjekke og handlinger som må utføres
«Spøkelses»- eller dobbeltbilder	<ul style="list-style-type: none">• Dette kan forårsakes av en antennehindring pga. høye bygninger eller fjell. Hvis du bruker en retningsbestemt antenne kan dette forbedre bildekvaliteten.
Ikke strøm	<ul style="list-style-type: none">• Sjekk om TV-ens strømledning er koblet til stikkontakten.• Koble fra TV-en, vent i 60 sekunder. Sett deretter inn støpselet i stikkontakten igjen og slå på TV-en igjen.
Intet bilde	<ul style="list-style-type: none">• Sjekk antennetilkoblingene på baksiden av TV-en for å se om antennen er riktig koblet til TV-en.• Mulige problemer med kringkastingsstasjonen. Prøv en annen kanal.• Justér kontrasten og lysstyrken.• Sjekk kontrollen for teksting. Noen TEKST-moduser kan blokkere skjermen.
Bra bilde men ingen lyd	<ul style="list-style-type: none">• Trykk på MUTE (DEMP)-knappen på fjernkontrollen for å påse at lyden er slått av.
Bra lyd, men dårlig farge	<ul style="list-style-type: none">• Juster innstillingene for kontrast, farge og lysstyrke.
Dårlig bilde	<ul style="list-style-type: none">• Dårlig bildekvalitet kan oppstå når et aktivert S-VHS-kamera eller videokamera kobles til TV-en og andre eksterne enheter samtidig. Slå av en av ekstrautstyret.
Kornete bilde og støy	<ul style="list-style-type: none">• Kontroller antennetilkoblingen.
Horisontal stiptet linje	<ul style="list-style-type: none">• Dette kan være forårsaket av elektrisk interferens (f.eks. hårføner, neonlys i nærheten osv.). Slå av utstyret.
TV-en reagerer ikke på fjernkontrollen	<ul style="list-style-type: none">• Kontroller om batteriene funker. Bytt ut om nødvendig.• Rengjør fjernkontrollsensorlinsen på TV-en.
Piksler (prikker) som alltid er mørke eller alltid lyser	<ul style="list-style-type: none">• TV-en din er presisjonsprodusert med et ekstremt høyt teknologinivå. Noen ganger kan det imidlertid hende at piksler ikke vises riktig. Denne typen hendelser er iboende for denne typen produkter og utgjør ikke et defekt produkt.

MERK

- Dette produktet bruker et panel som består av underpiksler som krever sofistikert teknologi for å produsere. Det kan imidlertid være noen få lyse eller mørke piksler på skjermen. Disse pikslene vil ikke ha noen innvirkning på ytelsen til produktet.



Begrepene HDMI, High-Definition Multimedia Interface, HDMI Trade dress og HDMI-logoen er varemerker eller registrerte varemerker til HDMI Licensing Administrator, Inc.



Dolby, Dolby Vision, Dolby Atmos, Dolby Audio og det dobbelte D-symbolet er varemerker som tilhører Dolby Laboratories Licensing Corporation. Produsert under lisens fra Dolby Laboratories. Konfidensielle upubliserte verk. Copyright ©2012-2024 Dolby Laboratories. Med enerett.

PRODUKTSPEKIFIKASJONER

43 tommer UHD LED-TV

TV-ens bildekvalitet:	UHD Integrert digital. Skjermstørrelse: 108 cm Oppløsning 3840x2160 piksler 60 Hz.
TV-system:	PAL-B/G, SECAM-B/G
DTV-tuner-dekoder	DVB-T, DVB-C, DVB-T2, DVB-S2 16/32/64/128/256 QAM-modulasjon MPEG2, MPEG4, H.265
Forbindelser:	1 optisk port 2 USB-porter 1 LAN 4 HDMI-kontakter 1 VIDEO-kontakt 1 V kontakt 1 H kontakt 2 RF-kontakter 1 hodetelefonport 1 CI-spor Støttede systemer: PAL+SECAM Lagringskanalnummer: 1000(DTV), 100(ATV) TV (RF): 75 Ω impedanse AV-videoinngang: 75 Ω, 1 V-P, RCA AV-lydinngang: 20 KΩ, 500 mV RMS HDMI-videoinngang: 480i, 480p, 720p, 1080i, 1080p, 2160p WiFi: Standard: IEEE 802.11 a/b/g/n/ac, frekvens: 2,4 GHz / 5 GHz Bluetooth: V5.1
Lydkvalitet:	Stereo lydsystem. 2 x 10 watt RMS-utgangseffekt.
Strømforbruk i standby	≤ 0,5 W
Digitale funksjoner:	Digitalt interaktiv. Digital tekst. Digital video kringkasting (DVB), undertekster tilgjengelig. Autooppsett. Autosøk etter nye kanaler. Nå og neste programguide. 7 dagers elektronisk programguide (EPG). CI-spor. Lydbeskrivelse-kompatibel.
Andre funksjoner:	UHF/VHF-tuner; innsovningstimer; barnesikring; bilde og tekst Fjernkontrollbatterier: krever 2 x AAA. VESA-festestørrelse: 300x300 mm Pakkestørrelse (BxHxD): 1075x652x142 mm Settstørrelse (BxHxD) med stativ: 957,2 x 607,4 x 240,7 mm Apparatets størrelse (BxHxD) uten stativ: 957,2 x 566,7 x 86,6 mm Pakkens vekt: 10 kg Angi vekt med stativ: 7,2 kg Angi vekt uten stativ: 6,8 kg

* Delespesifikasjonene for dette TV-apparatet som er gitt her er kun for referanse.
Det kan oppstå forskjeller når produktteknologien oppdateres.
Design og spesifikasjoner kan endres uten varsel.

PRODUKTSPEKIFIKASJONER

50 tommer UHD LED-TV

TV-ens bildekvalitet:	UHD Integrert digital. Skjermstørrelse: 126 cm Oppløsning 3840x2160 piksler 60 Hz.
TV-system:	PAL-B/G, SECAM-B/G
DTV-tuner-dekoder	DVB-T, DVB-C, DVB-T2, DVB-S2 16/32/64/128/256 QAM-modulasjon MPEG2, MPEG4, H.265
Forbindelser:	1 optisk port 2 USB-porter 1 LAN 4 HDMI-kontakter 1 VIDEO-kontakt 1 V kontakt 1 H kontakt 2 RF-kontakter 1 hodetelefonport 1 CI-spor Støttede systemer: PAL+SECAM Lagringskanalnummer: 1000(DTV), 100(ATV) TV (RF): 75 Ω impedanse AV-videoinngang: 75 Ω, 1 V-P, RCA AV-lydinngang: 20 KΩ, 500 mV RMS HDMI-videoinngang: 480i, 480p, 720p, 1080i, 1080p, 2160p WiFi: Standard: IEEE 802.11 a/b/g/n/ac, frekvens: 2,4 GHz / 5 GHz Bluetooth: V5.1
Lydkvalitet:	Stereo lydsystem. 2 x 13.5 watt RMS-utgangseffekt.
Strømforbruk i standby	≤ 0,5 W
Digitale funksjoner:	Digitalt interaktiv. Digital tekst. Digital video kringkasting (DVB), undertekster tilgjengelig. Autooppsett. Autosøk etter nye kanaler. Nå og neste programguide. 7 dagers elektronisk programguide (EPG). CI-spor. Lydbeskrivelse-kompatibel.
Andre funksjoner:	UHF/VHF-tuner; innsovningstimer; barnesikring; bilde og tekst Fjernkontrollbatterier: krever 2 x AAA. VESA-festestørrelse: 300x300 mm Pakkestørrelse (BxHxD): 1250x760x144 mm Settstørrelse (BxHxD) med stativ: 1111,2x710,5x277,2 mm Apparatets størrelse (BxHxD) uten stativ: 1111,2x651,8x88mm Pakkens vekt: 13,5 kg Angi vekt med stativ: 10 kg Angi vekt uten stativ: 9,5 kg

* Delespesifikasjonene for dette TV-apparatet som er gitt her er kun for referanse.
Det kan oppstå forskjeller når produktteknologien oppdateres.
Design og spesifikasjoner kan endres uten varsel.

PRODUKTSPEKIFIKASJONER

55 tommer UHD LED-TV

TV-ens bildekvalitet:	UHD Integrert digital. Skjermstørrelse: 139 cm Oppløsning 3840x2160 piksler 60 Hz.
TV-system:	PAL-B/G, SECAM-B/G
DTV-tuner-dekoder	DVB-T, DVB-C, DVB-T2, DVB-S2 16/32/64/128/256 QAM-modulasjon MPEG2, MPEG4, H.265
Forbindelser:	1 optisk port 2 USB-porter 1 LAN 4 HDMI-kontakter 1 VIDEO-kontakt 1 V kontakt 1 H kontakt 2 RF-kontakter 1 hodetelefonport 1 CI-spor Støttede systemer: PAL+SECAM Lagringskanalnummer: 1000(DTV), 100(ATV) TV (RF): 75 Ω impedanse AV-videoinngang: 75 Ω , 1 V-P, RCA AV-lydinngang: 20 K Ω , 500 mV RMS HDMI-videoinngang: 480i, 480p, 720p, 1080i, 1080p, 2160p WiFi: Standard: IEEE 802.11 a/b/g/n/ac, frekvens: 2,4 GHz / 5 GHz Bluetooth: V5.1
Lydkvalitet:	Stereo lydsystem. 2 x 13,5 watt RMS-utgangseffekt.
Strømforbruk i standby	\leq 0,5 W
Digitale funksjoner:	Digitalt interaktiv. Digital tekst. Digital video kringkasting (DVB), undertekster tilgjengelig. Autooppsett. Autosøk etter nye kanaler. Nå og neste programguide. 7 dagers elektronisk programguide (EPG). CI-spor. Lydbeskrivelse-kompatibel.
Andre funksjoner:	UHF/VHF-tuner; innsovningstimer; barnesikring; bilde og tekst Fjernkontrollbatterier: krever 2 x AAA. VESA-festestørrelse: 300x300 mm Pakkestørrelse (BxHxD): 1350x837x144 mm Settstørrelse (BxHxD) med stativ: 1225,8 x 777,3 x 277,2 mm Apparatets størrelse (BxHxD) uten stativ: 1225,8 x 719,4 x 88,1 mm Pakkens vekt: 16,4 kg Angi vekt med stativ: 11,9 kg Angi vekt uten stativ: 11,4 kg

* Delespesifikasjonene for dette TV-apparatet som er gitt her er kun for referanse.
Det kan oppstå forskjeller når produktteknologien oppdateres.
Design og spesifikasjoner kan endres uten varsel.

PRODUKTSPEKIFIKASJONER

65 tommer UHD LED-TV

TV-ens bildekvalitet:	UHD Integrert digital. Skjermstørrelse: 165 cm Oppløsning 3840x2160 piksler 60 Hz.
TV-system:	PAL-B/G, SECAM-B/G
DTV-tuner-dekoder	DVB-T, DVB-C, DVB-T2, DVB-S2 16/32/64/128/256 QAM-modulasjon MPEG2, MPEG4, H.265
Forbindelser:	1 optisk port 2 USB-porter 1 LAN 4 HDMI-kontakter 1 VIDEO-kontakt 1 V kontakt 1 H kontakt 2 RF-kontakter 1 hodetelefonport 1 CI-spor Støttede systemer: PAL+SECAM Lagringskanalnummer: 1000(DTV), 100(ATV) TV (RF): 75 Ω impedanse AV-videoinngang: 75 Ω , 1 V-P, RCA AV-lydinngang: 20 K Ω , 500 mV RMS HDMI-videoinngang: 480i, 480p, 720p, 1080i, 1080p, 2160p WiFi: Standard: IEEE 802.11 a/b/g/n/ac, frekvens: 2,4 GHz / 5 GHz Bluetooth: V5.1
Lydkvalitet:	Stereo lydsystem. 2 x 13,5 watt RMS-utgangseffekt.
Strømforbruk i standby	\leq 0,5 W
Digitale funksjoner:	Digitalt interaktiv. Digital tekst. Digital video kringkasting (DVB), undertekster tilgjengelig. Autooppsett. Autosøk etter nye kanaler. Nå og neste programguide. 7 dagers elektronisk programguide (EPG). CI-spor. Lydbeskrivelse-kompatibel.
Andre funksjoner:	UHF/VHF-tuner; innsovningstimer; barnesikring; bilde og tekst Fjernkontrollbatterier: krever 2 x AAA. VESA-festestørrelse: 400x300 mm Pakkestørrelse (BxHxD): 1600x960x164 mm Settstørrelse (BxHxD) med stativ: 1446,4x904,7x313,8 mm Apparatets størrelse (BxHxD) uten stativ: 1446,4x841,3x85,1 mm Pakkens vekt: 24 kg Angi vekt med stativ: 17,2 kg Angi vekt uten stativ: 16,5 kg

* Delespesifikasjonene for dette TV-apparatet som er gitt her er kun for referanse.
Det kan oppstå forskjeller når produktteknologien oppdateres.
Design og spesifikasjoner kan endres uten varsel.

Haier

Haier

Viver inspirado

Manual do
utilizador

MODELOS:

H43Q80FUX

H50Q80FUX

H55Q80FUX

H65Q80FUX



As ilustrações abaixo servem apenas como referência e poderão ser diferentes do aspeto atual do produto.

O design e as especificações do produto podem ser alterados sem aviso prévio.

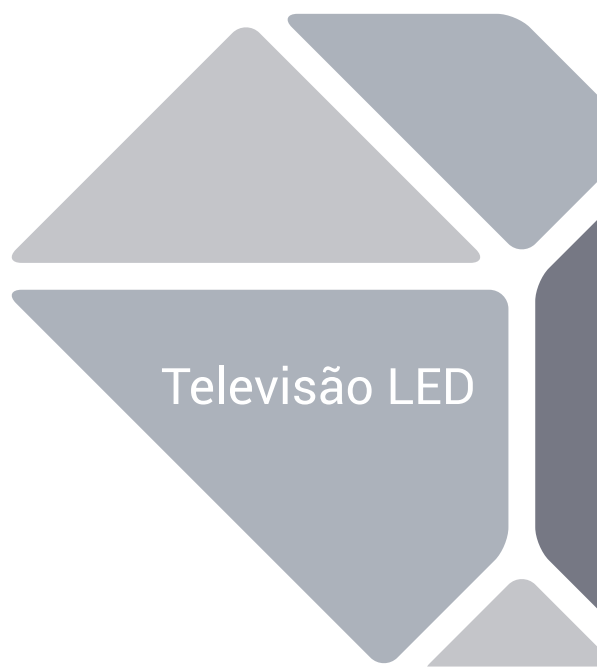

ÍNDICE

1. INSTRUÇÕES DE SEGURANÇA IMPORTANTES.....	1
2. PREPARAÇÃO.....	3
3. LIGAÇÃO DE PERIFÉRICOS E CONTROLOS.....	4
4. EFETUAR LIGAÇÕES.....	5
5. INSTRUÇÕES DE OPERAÇÃO.....	6
6. RESOLUÇÃO DE PROBLEMAS.....	19
7. ESPECIFICAÇÃO DO PRODUTO.....	20





As ilustrações abaixo servem apenas como referência e poderão ser diferentes do aspeto atual do produto. O design e as especificações do produto podem ser alterados sem aviso prévio.

INSTRUÇÕES DE SEGURANÇA IMPORTANTES

- 1) Leia estas instruções.
- 2) Guarde estas instruções.
- 3) Cumpra todos os avisos.
- 4) Siga todas as instruções.
- 5) Não utilize este aparelho perto de água.
- 6) Limpe-o apenas com um pano seco.
- 7) Não bloquear as aberturas de ventilação, instalar de acordo com as instruções.
- 8) Não instalar perto de fontes de calor, tais como radiações, registos de calor, fogões ou outros aparelhos (incluindo amplificadores) que produzam calor.
- 9) Não anule o objetivo de segurança da ficha polarizada. Se a ficha fornecida não for adequada para a sua tomada elétrica, consulte um electricista para substituição da tomada obsoleta.
- 10) Proteja o cabo elétrico para que não seja pisado ou entalado, principalmente junto das tomadas, nos componentes e no ponto de saída do aparelho.
- 11) Utilize apenas ligações/acessórios especificados pelo fabricante.
- 12) Desligue este aparelho da tomada durante trovoadas ou quando não o utilizar durante períodos prolongados.
- 13) As reparações devem ser realizadas apenas por pessoal qualificado. É necessária manutenção quando o aparelho tiver sido danificado de qualquer forma, como, por exemplo, o cabo ou a tomada de alimentação estão danificados, foi entornado líquido ou caíram objetos dentro do aparelho, este foi exposto a chuva ou humidade, não funciona normalmente ou foi deixado cair.
- 14) A ficha elétrica é utilizada como o dispositivo desligado, e este deverá manter-se sempre operacional.
- 15) A ventilação não deve ser obstruída cobrindo as aberturas de ventilação com itens, como jornais, toalhas de mesa, cortinas, etc.
- 16) Nenhuma fonte de chamas nuas, tais como velas acesas, deve ser colocada sobre o aparelho.
- 17) Deve ter em atenção os aspetos ambientais para a eliminação das pilhas.
- 18) A utilização do aparelho deve ser realizada em clima moderado.
- 19) O aparelho não deve ser exposto a gotas ou salpicos, e objetos que contenham líquidos, como jarras, não devem ser colocados sobre o aparelho.
- 20) Advertência: Para evitar ferimentos causados pela inclinação do produto, certifique-se sempre de que todo o produto foi colocado na superfície da mesa na horizontal.

* O aspeto do produto real pode variar em relação à imagem acima*.

Se for utilizada uma ficha no cabo de alimentação como dispositivo de corte, as instruções de instalação devem indicar que, no caso de equipamento com ficha, a tomada deve ser facilmente acessível.

	ATENÇÃO RISCO DE CHOQUE ELÉTRICO NÃO ABRIR!	
ATENÇÃO PARA REDUZIR O RISCO DE CHOQUE ELÉTRICO, NÃO REMOVA A COBERTURA (OU A PARTE POSTERIOR). NÃO EXISTEM NO INTERIOR PEÇAS REPARÁVEIS PELO UTILIZADOR. A ASSISTÊNCIA TÉCNICA DEVE SER EFECTUADA POR PESSOAL QUALIFICADO.		



O símbolo indica que estão presentes nesta unidade tensões perigosas que constituem um risco de choque elétrico.



O símbolo indica que existem instruções importantes de funcionamento e manutenção na literatura que acompanha esta unidade.

ADVERTÊNCIA:

Para reduzir o risco de ocorrência de incêndio ou de choques elétricos, não exponha este aparelho à chuva ou à humidade.

ADVERTÊNCIA:

As pilhas não devem ser expostas ao calor excessivo como luz do sol, fogo ou similares.



Este símbolo indica que este produto incorpora um isolamento duplo entre a tensão de rede perigosa e as peças acessíveis ao utilizador. Quando em manutenção utilize apenas peças de reposição idênticas.



Esta marcação indica que o produto não deve ser eliminado juntamente com os resíduos domésticos. Para evitar possíveis danos ao meio ambiente ou à saúde humana por motivo de uma eliminação não controlada de resíduos, recicle-o de forma a promover a reutilização sustentável de recursos materiais. Para devolver o seu aparelho usado, recorra ao sistema de devolução e recolha ou contacte o revendedor que lhe vendeu o produto. Podem levar este produto para uma reciclagem ambientalmente segura.

INSTRUÇÕES DE SEGURANÇA IMPORTANTES

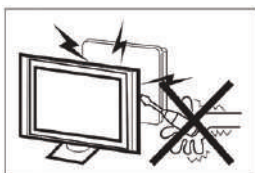

Este televisor funciona com tensões elevadas. Não retire a parte de trás da caixa do seu aparelho. A assistência técnica deve ser efectuada por pessoal qualificado.

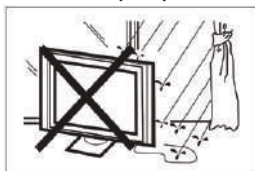

Para evitar o risco de incêndio ou de choque eléctrico, não exponha o televisor à chuva ou à humidade.



Não deixe cair nem empurre objetos para as ranhuras ou aberturas do televisor. Nunca derrame qualquer tipo de líquido sobre o televisor.



Não obstrua os orifícios de ventilação na tampa traseira. Uma ventilação adequada é essencial para evitar falhas nos componentes eléctricos.



Não prender o cabo de alimentação debaixo do televisor.



Se for limpar o produto, desligue o televisor da tomada, utilize um tecido macio, sem água e nunca produtos químicos.



Nunca se apoie, incline ou empurre subitamente o televisor ou o seu suporte. Deve prestar especial atenção às crianças. Se o televisor cair, podem ocorrer ferimentos graves.

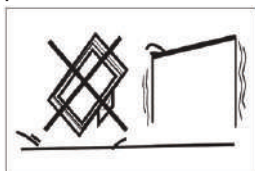

Não coloque o televisor num carrinho, suporte, prateleira ou mesa instável. Se o televisor cair, podem ocorrer ferimentos graves e danos no televisor.

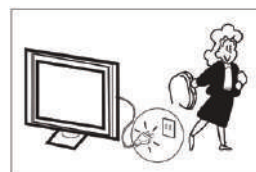

Quando o recetor de televisão não for utilizado durante um longo período de tempo, é aconselhável desligar o cabo de alimentação de CA da tomada de CA.



Evite expor o televisor à luz solar direta e a outras fontes de calor. Não coloque o televisor diretamente sobre outros produtos que libertem calor, como, por exemplo, leitores de cassetes de vídeo e amplificadores de áudio. Não colocar fontes de chama livre, como velas acesas, sobre o televisor.

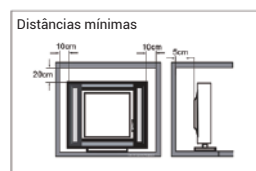

Se o televisor for montado num compartimento ou numa caixa semelhante, devem ser respeitadas as distâncias mínimas. A acumulação de calor pode reduzir a vida útil do televisor e pode também ser perigosa. Nota: a utilização do aparelho deve ser realizada em climas moderados.

Cuidado:

O aparelho de televisão pode cair e provocar lesões pessoais graves ou morte. É possível evitar inúmeras lesões, particularmente em crianças, tomando as seguintes medidas de precaução simples:

- Utilize SEMPRE armários ou suportes ou métodos de montagem recomendados pelo fabricante do televisor.
- Utilize SEMPRE móveis que consigam suportar o peso do aparelho de televisão em segurança.
- Assegure SEMPRE que o aparelho de televisão não fica saliente junto à extremidade do móvel de suporte.
- Informe SEMPRE as crianças sobre os perigos de subir para cima dos móveis para alcançar o televisor ou os seus comandos.
- Organize SEMPRE os fios e cabos ligados ao televisor de forma a que não possam tropeçar, ser puxados ou agarrados.
- NUNCA coloque o aparelho de televisão num local instável.
- NUNCA coloque o televisor em cima de móveis altos (por exemplo, armários ou estantes) sem fixar tanto o móvel como o televisor num suporte adequado.
- NUNCA coloque o televisor sobre tecidos ou outros materiais que possam estar situados entre o televisor e os móveis de apoio.
- NUNCA coloque objetos que possam incitar as crianças a trepar, como brinquedos e comandos à distância, em cima do televisor ou do móvel onde o televisor está colocado.

Se o televisor existente for mantido e transferido para outro local, devem ser aplicadas as mesmas considerações acima referidas.

PREPARAÇÃO

IMPORTANTE: Não exerça pressão sobre a área de visualização do ecrã, o que pode comprometer a integridade do mesmo. A garantia do fabricante não cobre abusos por parte do utilizador ou instalações inadequadas.

FIXAÇÃO DO SUPORTE

IMPORTANTE: O suporte do televisor deve ser montado antes da sua utilização.

1. Colocar a unidade de TV virada para baixo sobre uma superfície macia e plana (cobertor, espuma, pano, etc.) para evitar danos na TV.
2. Fixar o suporte na parte inferior do televisor com os 6 parafusos.

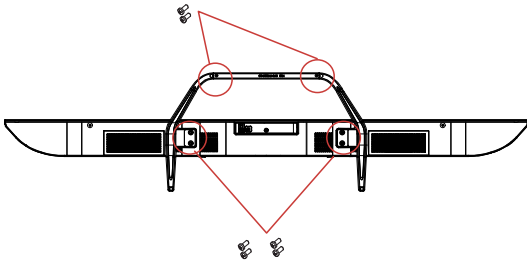

! NOTA
O aspeto do produto deve ser semelhante.

PREPARAÇÃO DO TELEVISOR LED PARA MONTAGEM NA PAREDE

Sugerimos que mantenha o televisor a uma distância mínima de 60 mm (2,36 polegadas) da parede para evitar interferências nos cabos. Antes de montar o televisor na parede, é necessário retirar o suporte. Para sua segurança, utilize apenas um suporte de montagem na parede certificado pela UL com o peso mínimo do televisor sem suporte.

Para fixar um suporte de montagem na parede ao televisor:

1. Retire os parafusos que prendem o televisor ao suporte.
2. Retire o suporte do televisor.
3. Fixe o suporte de montagem na parede na parte de trás do televisor utilizando quatro parafusos. Siga as instruções do manual do utilizador que acompanha o suporte de montagem na parede para efetuar a instalação.

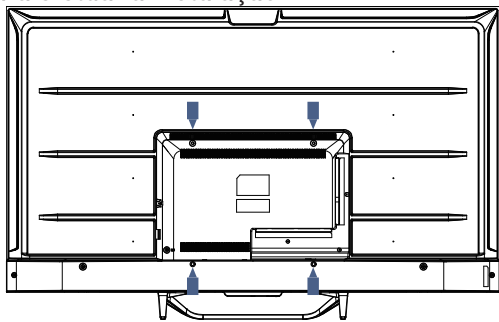

! NOTA
O suporte de montagem na parede não está incluído.

4. Fixe os parafusos de montagem na parede (4 parafusos M6 de 12 mm) na parte de trás do televisor LED, utilizando o binário de 12 kgf,cm.

LIGAR A TV

1. Instale o suporte e coloque a TV sobre uma superfície sólida.

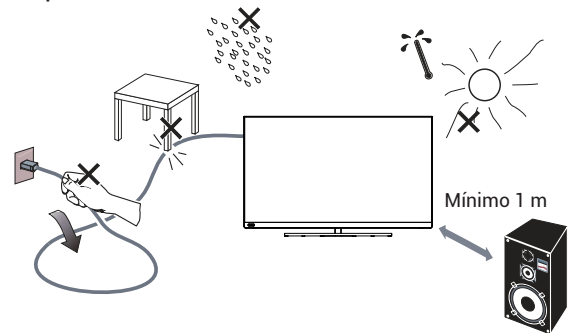

! NOTA

- Certifique-se de que a TV é colocada numa posição que permita a livre circulação de ar. Não cubra as aberturas de ventilação na tampa traseira.
 - Para evitar situações de insegurança, não devem ser colocadas fontes de chama aberta, como velas acesas, em cima ou nas proximidades do televisor.
 - Evite o calor, a luz solar direta e a exposição à chuva ou à água. O equipamento não deve ser exposto a pingos ou salpicos.
2. Ligue o cabo da antena ou o cabo da TV por cabo à tomada da antena **ANT IN** na parte de trás do televisor.
 3. Telecomando:
Retire a tampa do compartimento das pilhas. Introduza 2 pilhas (tipo AAA 1,5V).

CUIDADO: Existe risco de fogo ou explosão se a pilha for substituída por outra de tipo incorreto.

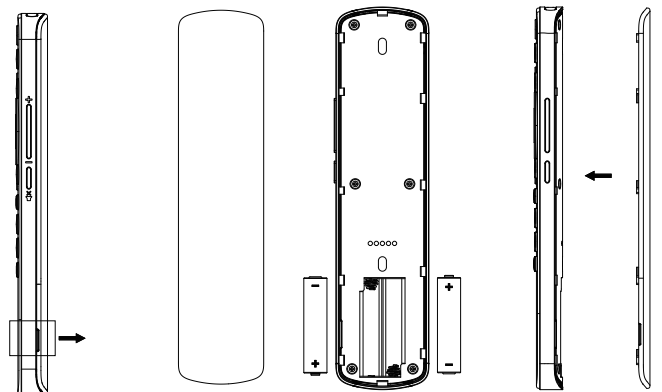

4. Alimentação:
ligue o cabo a uma tomada elétrica em funcionamento.

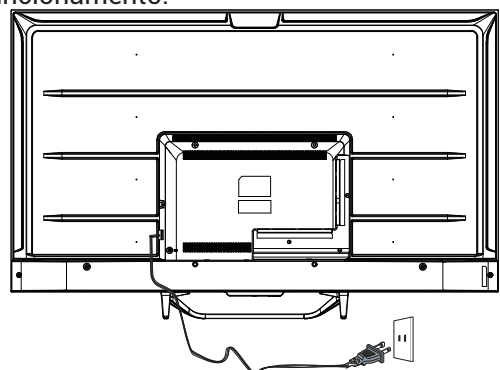

5. Ligar a TV:
Prima no telecomando ou o botão **POWER** no painel de controlo lateral do televisor.

LIGAÇÃO DE PERIFÉRICOS E CONTROLOS

CONTROLO POR BOTÃO

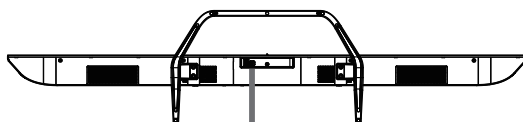
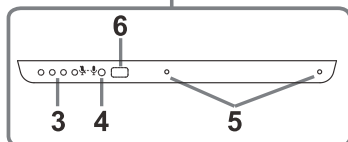
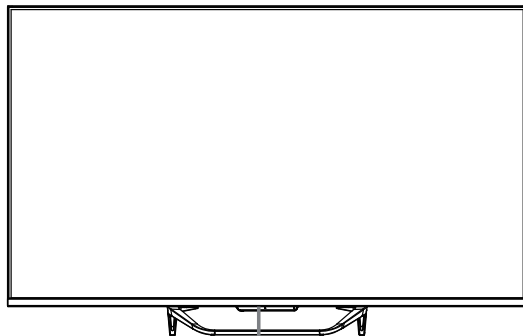

1 2

1. Ligar/Desligar
2. Voz ligada / Voz desligada
 - 🗣️ Ativar o Assistente de campo distante
 - 🗣️ Desativar o Assistente de campo distanteRode-o para a direita para o ligar, a luz indicadora acende-se e depois apaga-se, a função de voz foi iniciada. Pode dizer "Ok Google" para utilizar a função de voz e o indicador acende-se quando o televisor recebe a voz e, em seguida, diz diretamente o seu pedido.
Rode-o para a esquerda para a posição (Off) Desligado e sair da função de voz, a luz indicadora passa a amarelo.
3. Luz do Assistente de campo distante
4. Recetor do sinal do telecomando
5. Recetor do sinal de voz
6. LED de alimentação

! NOTA
Certifique-se de que o televisor está ligado à Internet antes de utilizar o Voice.
Selecione a opção (On) Ligado antes de utilizar o Voice.
Inicie sessão na sua conta GOOGLE antes de utilizar o Voice.

ACESSÓRIOS

- Telecomando - 1 unidade
- Manual do utilizador - 1 unidade
- Parafusos - 6 unidades
- Guia de início rápido - 1 unidade
- Cartão de garantia - 1 unidade

LIGAÇÃO DOS PERIFÉRICOS



Todos os terminais são (da esquerda para a direita):
LAN, ÓTICO, VÍDEO, L, R, HDMI4, HDMI3, HDMI2,



Todos os terminais são (da esquerda para a direita):
HDMI1 (eARC/ARC), LNB IN (SATÉLITE), ANT IN (ANTENA/CABO), USB1 , USB2, AURICULAR, CI.

EFETUAR LIGAÇÕES

EQUIPAMENTO AV

Esta TV fornece um grupo de AV para uma ligação conveniente ao gravador de vídeo, DVD ou outro equipamento de vídeo.

Consulte também o manual do proprietário do equipamento a ser ligado.

Pode utilizar os terminais de entrada na parte de trás da TV da seguinte forma.

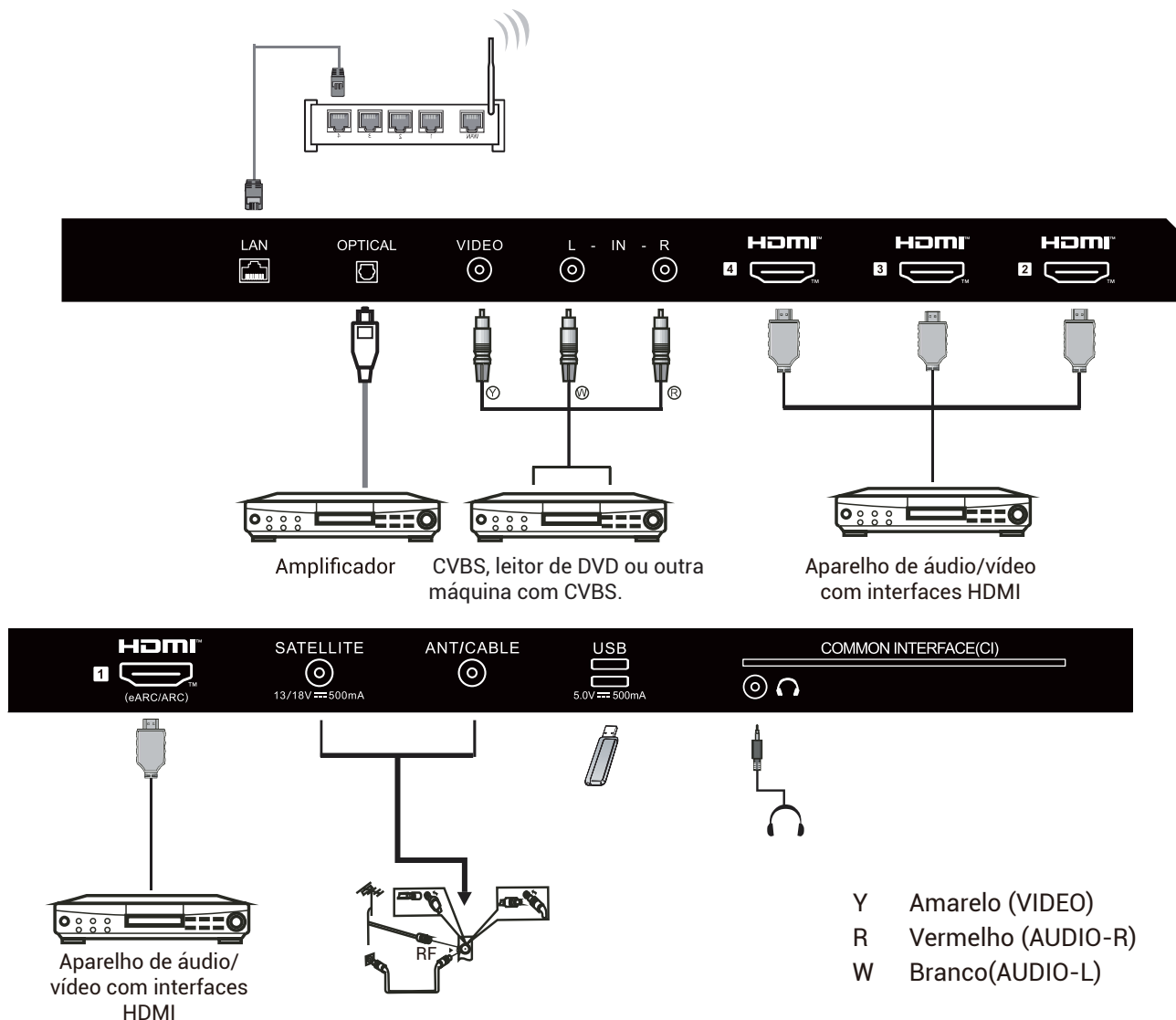

Pode ser ligado aos seguintes aparelhos: Gravador de vídeo, leitor multi-disco, DVD, câmara de vídeo, videojogo ou sistema estéreo, etc....

Nota:

Por vezes, não é compatível com diferentes dispositivos, porque o dispositivo fornece um sinal não normalizado.

INSTRUÇÕES DE OPERAÇÃO

UTILIZAR O TELECOMANDO

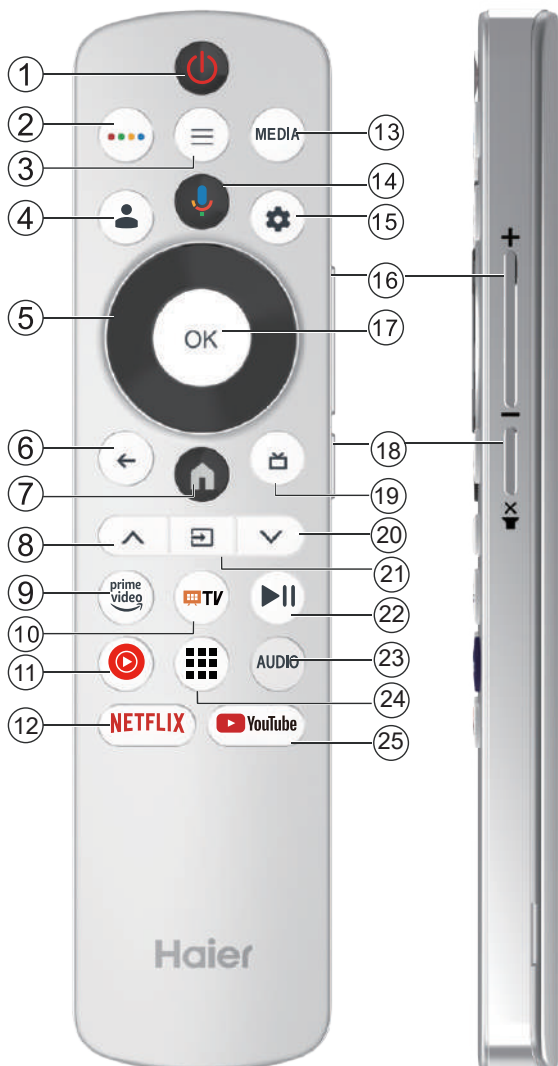

#	Item	Descrições
1	Ligar/desligar	Prima para ligar ou desligar a TV. Quando a TV está desligada, a energia continua a passar por ela. Para desligar completamente a alimentação, desligue o cabo de alimentação
2		Prima para abrir o MAGIC BOARD.
3		Prima para abrir ou fechar o menu no ecrã.
4		Prima para Contas e início de sessão na Google TV. (Ao configurar a TV básica, esta tecla não tem qualquer efeito)
5		Prima para navegar no menu no ecrã.
6		Para voltar ao menu anterior.
7		Prima para abrir a Página inicial
8		Prima para mudar os canais de TV.
9		Prima para o Prime Video para ver séries de TV e filmes online (é necessária uma ligação à Internet).
10		Prima para abrir a TV em direto.
11		Prima para abrir o YouTube Music.
12		Prima para abrir a NETFLIX.
13	MEDIA	Prima para abrir o Multi Media Player.
14		Prima para abrir o Assistente do Google ou iniciar a pesquisa por voz.
15		Prima para abrir o menu de definições.
16	VOL+VOL-	Prima VOL+ or VOL- para ajustar o nível do volume.
17	OK	Entrar na opção seleccionada ou executar a operação seleccionada.
18		Premir para silenciar ou repor o som.
19		Prima para apresentar o guia do programa eletrónico no modo de TV.
20		Prima para mudar os canais de TV.
21		Prima para abrir a lista de fontes de entrada.
22		Prima para reproduzir/pausar no modo multimédia.
23	AUDIO	Prima para mudar de faixa de áudio.
24		Prima para abrir as aplicações.
25		Prima para abrir o YouTube.

INSTRUÇÕES DE OPERAÇÃO

CONFIGURAÇÃO INICIAL

A primeira vez que ligar a TV, o assistente de configuração guiá-lo-á na configuração das definições básicas.

Consulte a Sugestão de texto para a Primeira configuração.

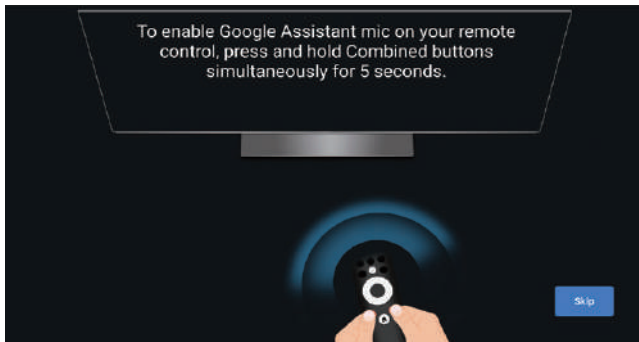

Esta função é utilizada para o código de emparelhamento do telecomando. Depois de o código ter sido introduzido com êxito, pode utilizar o telecomando Bluetooth para operar o televisor.

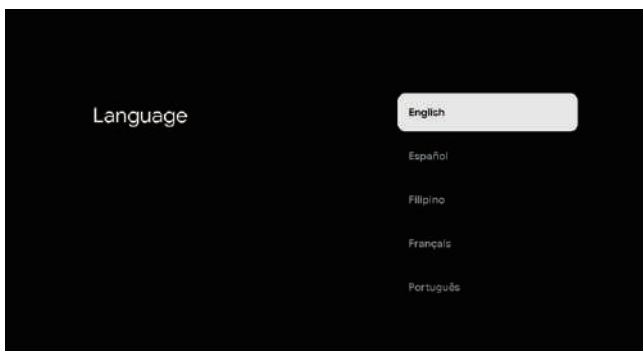

Prima ▲/▼ para seleccionar a língua do sistema e prima OK para confirmar a língua.

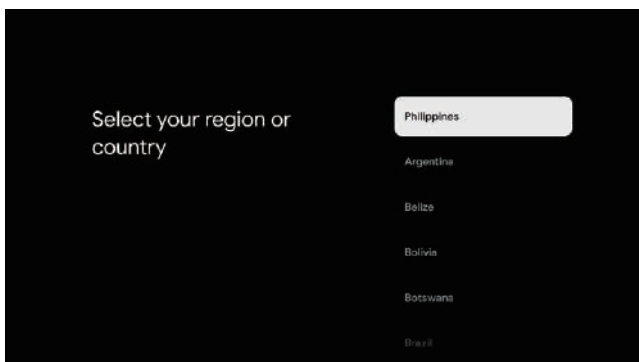

Prima ▲/▼ para seleccionar o seu país ou região e prima OK para confirmar.

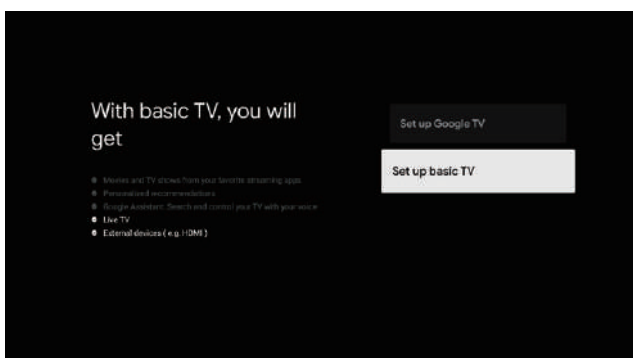

Prima ▲/▼ para seleccionar a opção "Set up basic TV (Configurar TV básica)" do seu dispositivo e prima OK para concluir a configuração.

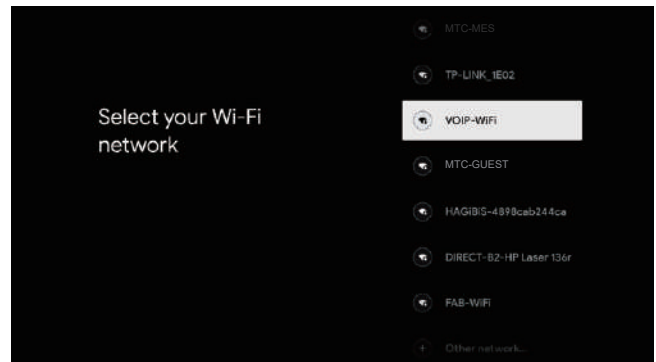

Prima ▲/▼ para seleccionar a rede Wi-Fi a ligar, prima OK e introduza a palavra-passe para confirmar que a ligação foi bem sucedida.

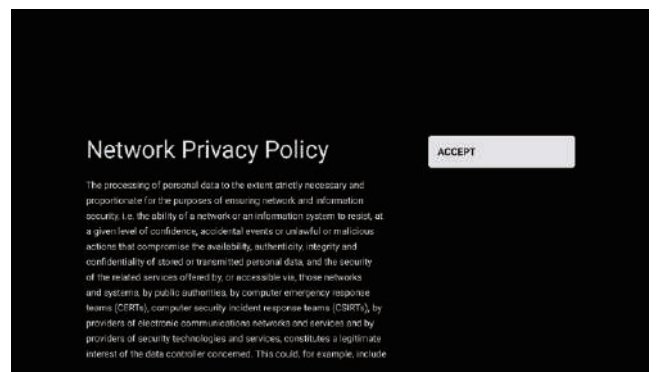

Selecione "Accept (Aceitar)" para aceitar estes termos da Política de Privacidade da Rede.

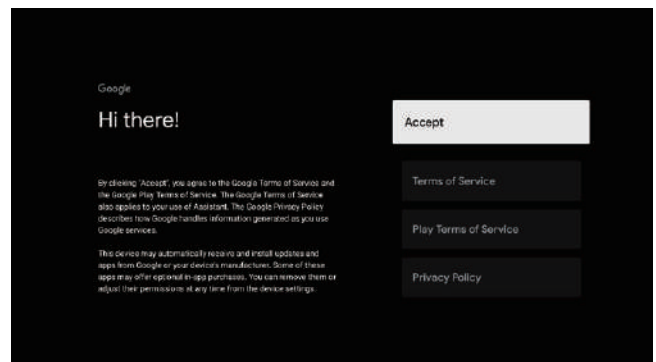

Ao aceitar os Termos de Serviço do Google para melhorar a experiência do produto, seleccione "Accept (Aceitar)" para aceitar esta condição.

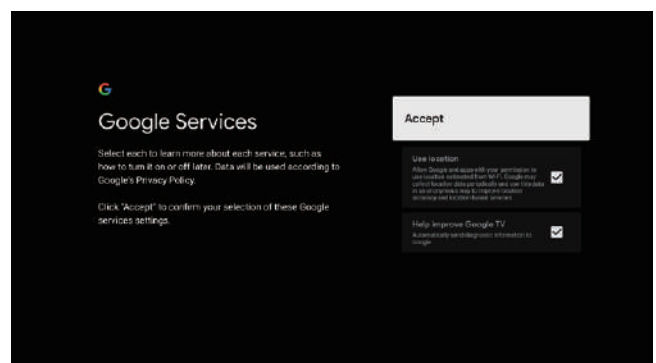

INSTRUÇÕES DE OPERAÇÃO

Ao aceitar os Serviços Google para melhorar a experiência do produto, selecione "Accept (Aceitar)" para aceitar esta condição.

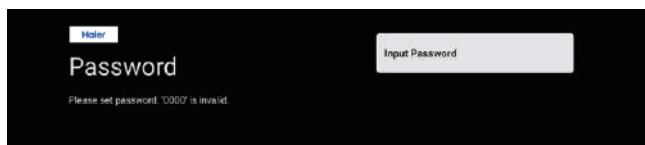

Utilizado para definir a palavra-passe do seu dispositivo para garantir a segurança e a privacidade.

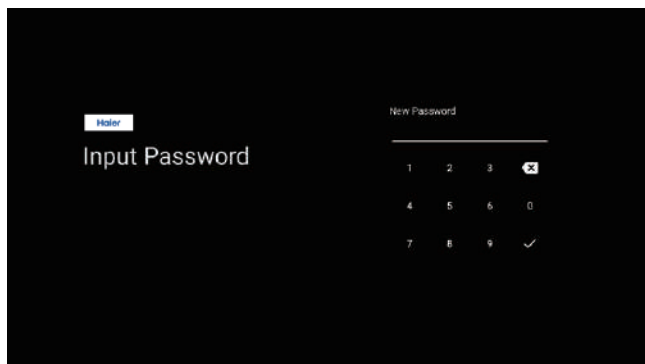

Utilize o telecomando/ teclado virtual para introduzir a palavra-passe de 4 dígitos e saltar automaticamente para a interface seguinte.

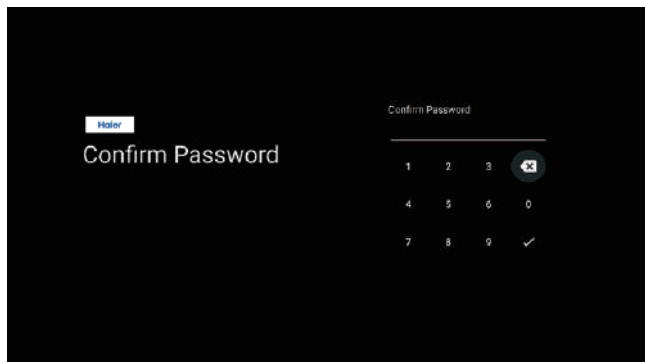

Confirme novamente a palavra-passe e mantenha-a constante. Utilize o telecomando/teclado virtual para introduzir a palavra-passe e completar a palavra-passe.

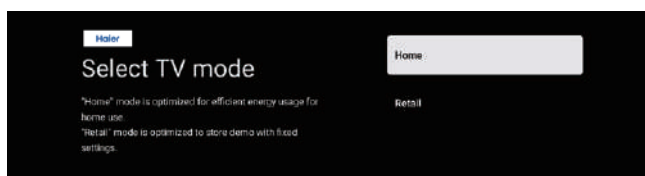

Para seleccionar o modo, prima a tecla ▲/▼ para seleccionar o modo Home (Casa) e prima OK.

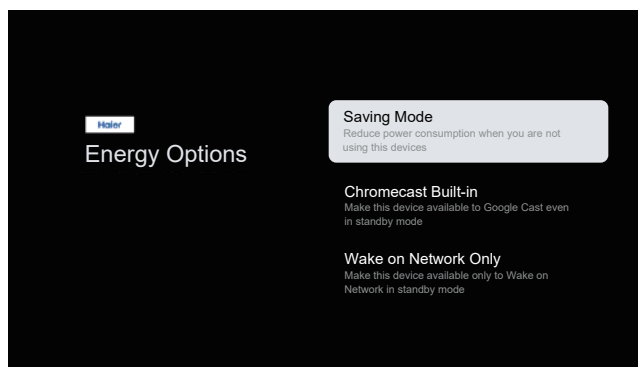

Selecione "Saving Mode (Modo de poupança)" e avance para o passo seguinte.

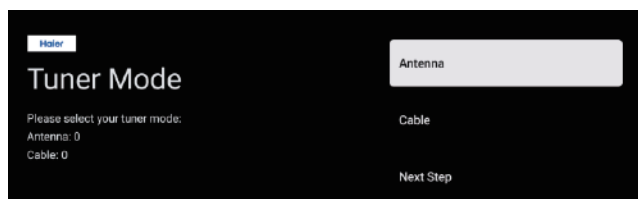

Selecione o modo de "Tuner (Sintonizador)" para procurar, prima para seleccionar e prima OK para confirmar.

INSTRUÇÕES DE OPERAÇÃO

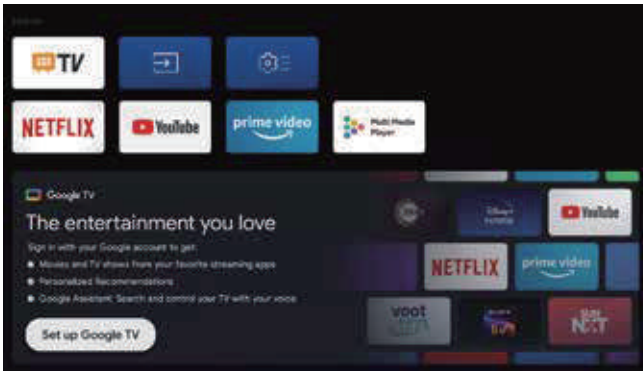

- Uma vez na interface do utilizador, pode mudar das definições básicas de TV para as definições do Google TV.

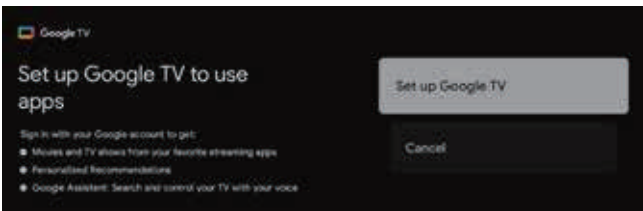

Prima ▲/▼ para seleccionar a opção "Set up Google TV (Configurar Google TV)" do seu dispositivo e prima OK para concluir a configuração.

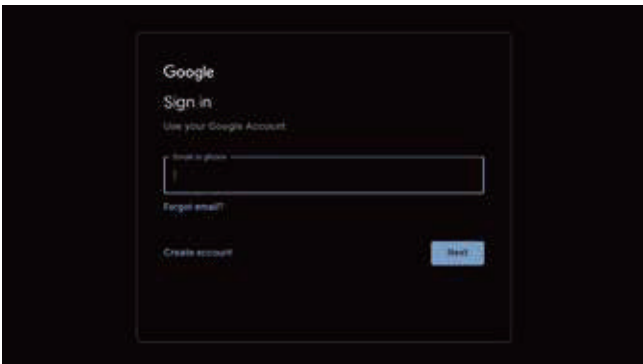

Utilizar o seu Início de sessão da conta Google

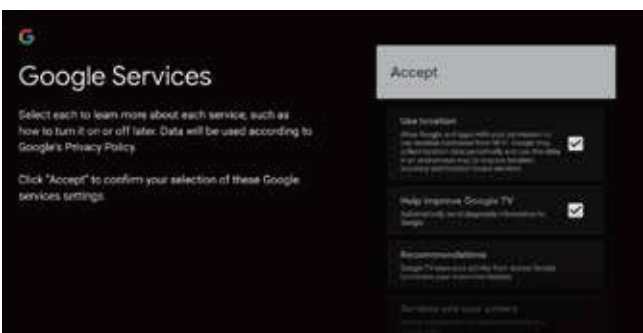
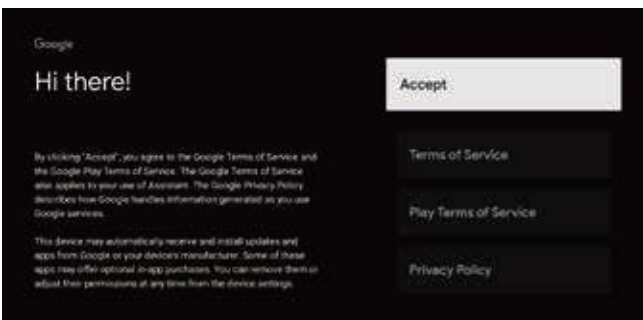

Ao aceitar os Termos de Serviço do Google para melhorar a experiência do produto, seleccione "Accept (Aceitar)" para aceitar esta condição.

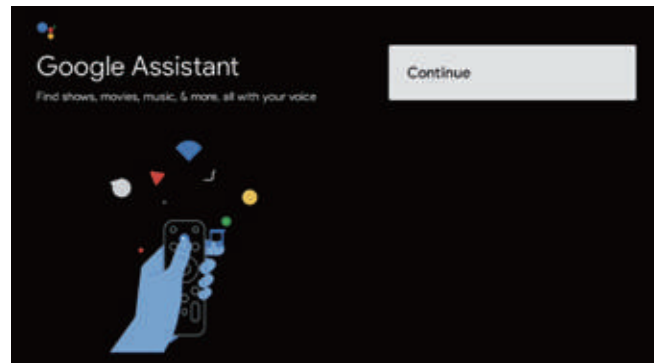

Prima para seleccionar e prima OK para continuar.

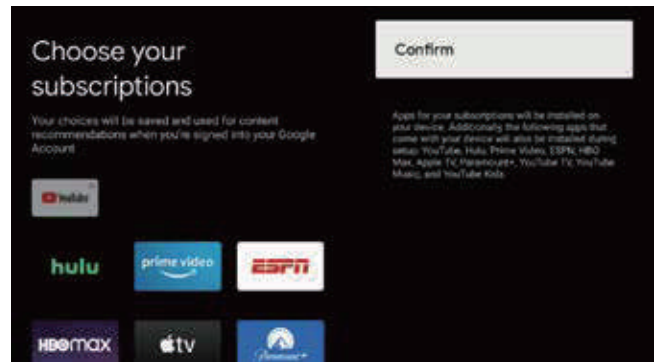

Prima ▲/▼ para seleccionar a opção "Choose your subscriptions (Escolher as suas subscrições)" e prima OK.

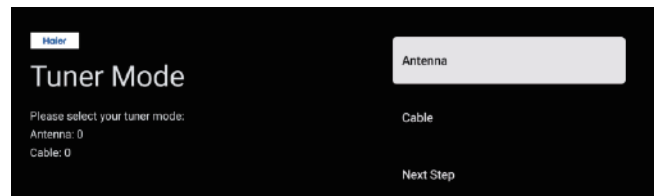

INSTRUÇÕES DE OPERAÇÃO

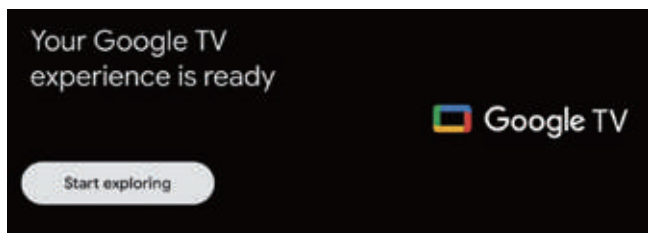

A sua experiência de Google TV está pronta e prima OK para Começar a explorar.

ECRÃ INICIAL

Depois de concluir as definições do assistente, pode ver televisão e ir para o ecrã inicial.

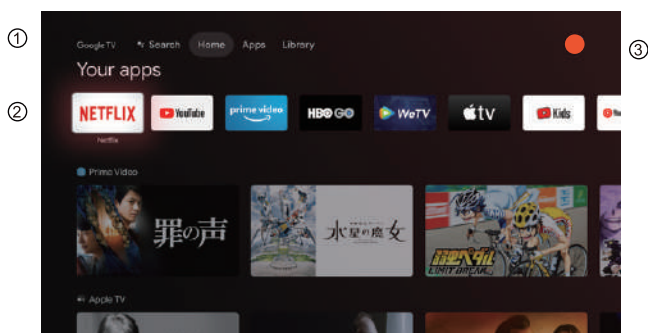

- 1 **Search** Abra o assistente do Google ou inicie uma pesquisa por voz.
Home Abra a página inicial da sua TV.
Apps Abra a lista de aplicações que instalou e adicione as suas aplicações favoritas.
Library Veja os conteúdos comprados e alugados na conta de utilizador.
- 2 Uma lista das aplicações que instalou e dos programas de envio de conteúdos que instalou.
- 3 Abra as informações da sua conta, definições, hora, entradas e imagem.
Settings (Definições): Aqui podem ser configuradas várias definições. Para mais informações sobre as definições, consulte a explicação seguinte.
Inputs (Entradas): Ícone para seleccionar uma fonte de entrada.
Picture (Imagem): O utilizador pode definir a imagem do televisor. Consulte a página 12 para obter instruções pormenorizadas sobre a configuração.

NAVEGAR NO MENU NO ECRÃ

Existem duas formas de aceder. Primeiro, na TV em direto, prima o botão de menu para visualizar as opções de TV, prima ▲/▼/◀/▶ para seleccionar o menu de definições e prima OK para confirmar. Segundo, na interface HOME (INÍCIO), prima a tecla ▶ para seleccionar o ícone do menu ⚙️, prima OK para confirmar.

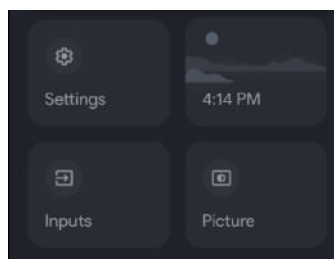
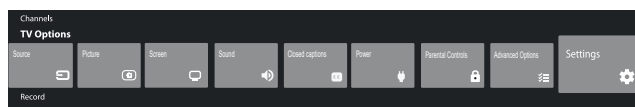

Prima o botão ▲/▼ para seleccionar o que pretende definir. Prima OK para entrar na definição.

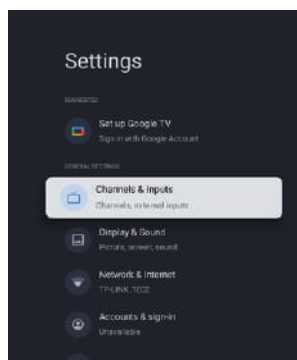

Prima BACK (VOLTAR) para regressar ao menu anterior.

Se o menu principal for apresentado, premir BACK (VOLTAR) fechará o menu no ecrã.

INSTRUÇÕES DE OPERAÇÃO

CANAIS

Menu->Settings->Channels & Inputs->Channels.
(Menu->Definições->Canais e Entradas->Canais).

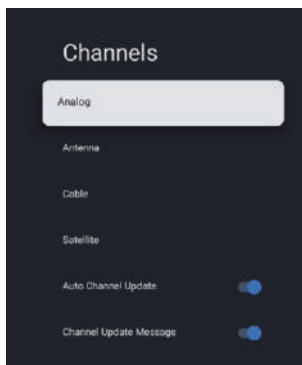

Analog/Antenna/Cable/Satellite (Analógico/Antena/Cabo/Satélite) - Prima o botão ▲/▼ para selecionar a opção e, em seguida, prima o botão OK para aceder ao submenu.

Auto Channel Update (Atualização automática de canal) - Prima o botão OK para escolher ON/OFF (LIGAR/DESLIGAR). Ao selecionar ON (LIGAR), o sistema irá procurar e atualizar automaticamente os canais após 5 minutos de espera.

Channel Update Message (Mensagem de atualização de canal) - Prima o botão OK para escolher ON/OFF (LIGAR/DESLIGAR). Ao selecionar ON (LIGAR), o sistema mostra a mensagem de atualização.

Nota: A fonte disponível pode ser diferente dependendo do modelo.

ENTRADAS

Menu->Settings->Channels & Inputs->Inputs (Menu->Definições->Canais e Entradas->Entradas).

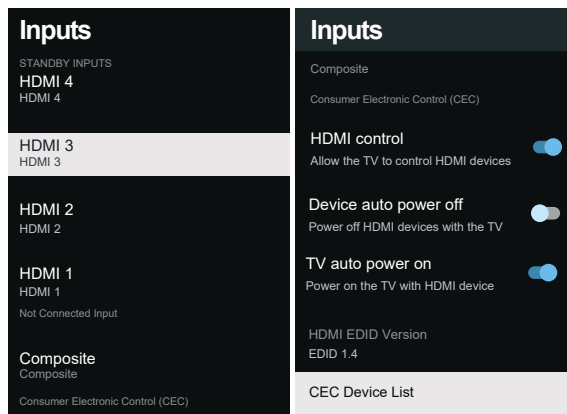

Inputs (Entradas) – Prima o botão ▲/▼ para selecionar a opção e, em seguida, prima o botão OK para entrar no sub-menu.

HDMI control (Controlo de HDMI) – Prima o botão ▲/▼ para selecionar a opção e, em seguida, prima o botão OK para selecionar LIGAR/DESLIGAR.

Device auto power off (Desligar automático do dispositivo) – Prima ▲/▼ para selecionar a opção e, em seguida, prima o botão OK para escolher LIGAR/DESLIGAR.

TV auto power on (Ligação automática da TV) – Prima o botão ▲/▼ para selecionar a opção e, em seguida, prima o botão OK para escolher LIGAR/DESLIGAR.

HDMI EDID Version (Versão EDID HDMI) – mostrar a versão EDID.

CEC Device List (Lista de dispositivos CEC) – Prima o botão ▲/▼ para selecionar a opção e, em seguida, prima o botão OK para aceder ao sub-menu.

ECRÃ E SOM

Menu->Settings-> Display & Sound (Menu->Definições-> Ecrã e Som)

Neste menu, pode definir a imagem, o som e a saída de áudio do televisor.

1. Prima o botão ▲/▼ para selecionar o que pretende definir.
2. Prima o botão OK para
3. Depois de terminar o ajuste, prima o botão BACK (VOLTAR) para regressar ao menu anterior.

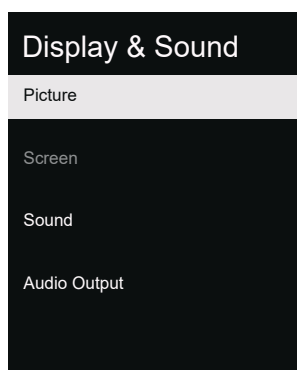

INSTRUÇÕES DE OPERAÇÃO

IMAGEM

Menu->Settings-> Display & Sound-> Picture (Menu->Definições-> Ecrã e Som-> Imagem)

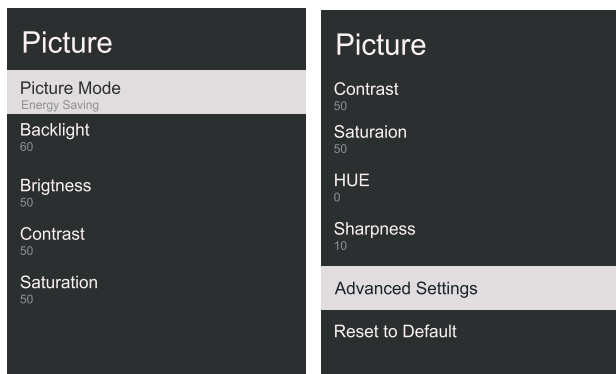

Picture Mode (Modo de Imagem) – Prima o botão ▲/▼ para seleccionar o botão de opção para aceder ao sub-menu. (Opcional: utilizador, Padrão, Vívido, Desporto, Filme, Jogo, Poupança de energia).

Backlight/Brightness/Contrast/Saturation/HUE/Sharpness (Retroiluminação/Brilho/Contraste/Saturação/Azul/Nitidez) – Prima o botão ▲/▼ para seleccionar a opção e, em seguida, prima o botão OK para aceder.

Prima o botão ◀ para reduzir o parâmetro. Premir o botão ▶ para aumentar o parâmetro.

Advanced Settings (Definições avançadas) – Prima o botão ▲/▼ para seleccionar a opção e, em seguida, prima o botão OK para aceder ao sub-menu.

Reset to Default (Repor predefinição) – Repor todas as definições para as predefinições de fábrica.

SOM

Menu->Settings-> Display & Sound->Sound (Menu->Definições-> Ecrã e Som->Som).

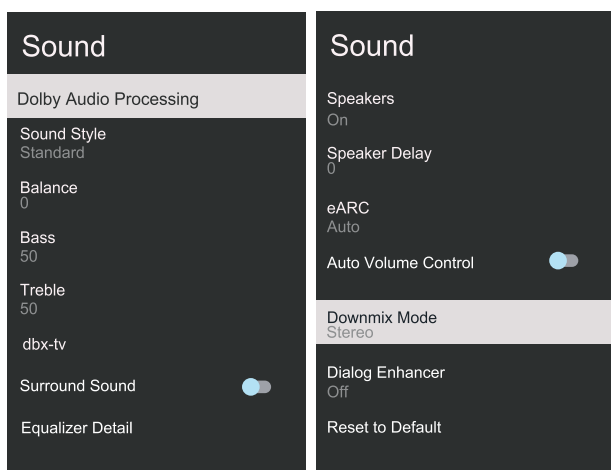

Dolby Audio processing (Processamento de áudio Dolby)– Prima o botão ▲/▼ para seleccionar a opção e, em seguida, prima o botão OK para aceder ao sub-menu.

Sound Style (Estilo do som) – Prima o botão ▲/▼ para seleccionar a opção e, em seguida, prima o botão OK para aceder ao sub-menu. (Opcional: utilizador, Padrão, Noite, Desporto, Filme, Música, Notícias).

Balance/ Bass/ Treble (Equilíbrio/ Graves/ Agudos) – Prima o botão ▲/▼ para seleccionar a opção e, em seguida, prima o botão OK para aceder ao sub-menu.

Prima o botão ◀ para reduzir o parâmetro. Premir o botão ▶ para aumentar o parâmetro.

dbx- tv – Prima o botão ▲/▼ para seleccionar a opção e, em seguida, prima o botão OK para aceder ao sub-menu.

Surround Sound (Som surround) – Prima o botão ▲/▼ para seleccionar a opção e, em seguida, prima o botão OK para escolher LIGAR/DESLIGAR.

Equalizer Detail (Detalhe do equalizador) – Prima o botão ▲/▼ para seleccionar a opção e, em seguida, prima o botão OK para aceder ao sub-menu.

Speakers (Altifalantes) – Prima o botão ▲/▼ para seleccionar a opção e, em seguida, prima o botão OK para seleccionar LIGAR/DESLIGAR.

Speaker Delay (Atraso nos altifalantes) – Prima o botão ▲/▼ para seleccionar a opção e, em seguida, prima o botão OK para seleccionar.

Prima o botão ◀ para reduzir o parâmetro. Premir o botão ▶ para aumentar o parâmetro.

eARC – Prima o botão ▲/▼ para seleccionar a opção e, em seguida, prima o botão OK para escolher Automático/DESLIGAR.

Auto Volume Control (Controlo de volume automático) – Prima o botão ▲/▼ para seleccionar a opção e, em seguida, prima o botão OK para escolher LIGAR/DESLIGAR.

Downmix Mode (Modo Downmix) – Prima o botão ▲/▼ para seleccionar a opção e, em seguida, prima o botão OK para aceder ao sub-menu. (Opcional: Estéreo, Surround).

Dialog Enhancer (Otimizador de diálogo) – Prima o botão ▲/▼ para seleccionar a opção e, em seguida, prima o botão OK para aceder ao sub-menu. (Opcional: Desligado, Baixo, Médio e Alto).

Reset to Default (Repor predefinição) – Repor todas as definições para as predefinições de fábrica.

SAÍDA DE ÁUDIO

Menu->Settings-> Display & Sound-> Audio Output (Menu->Definições-> Ecrã e Som-> Saída de Áudio).

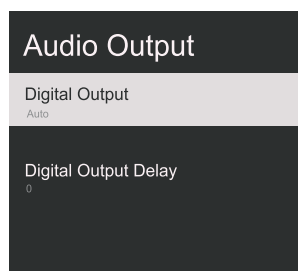

Digital Output (Saída digital) – Prima o botão ▲/▼ para seleccionar a opção e, em seguida, prima o botão OK para aceder ao sub-menu. (Opcional: Auto, Bypass, PCM, Dolby Digital Plus e Dolby Audio-Dolby Digital).

Digital Output Delay (Atraso da saída de áudio) – Prima o botão ▲/▼ para seleccionar a opção e, em

INSTRUÇÕES DE OPERAÇÃO

seguida, prima o botão **OK** para selecionar.
Prima o botão ◀ para reduzir o parâmetro.
Premir o botão ▶ para aumentar o parâmetro.

REDE

Menu->Settings->Network & Internet (Menu->Definições->Rede e Internet)

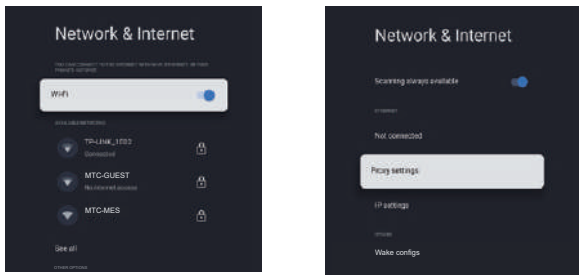

1. Prima o botão ▲/▼ para selecionar o que pretende definir.
2. Prima o botão **OK** para confirmar.
3. Depois de terminar o seu ajuste, prima o botão **OK** para guardar e regressar ao menu anterior.

CONTAS E INÍCIO DE SESSÃO

1. Menu->Settings->Accounts & sign-in (Menu->Definições->Contas e início de sessão).
2. Na interface HOME (INÍCIO), prima o botão ▲/▼ para selecionar "Set up Google TV (Configurar Google TV)" e avançar para o passo seguinte.

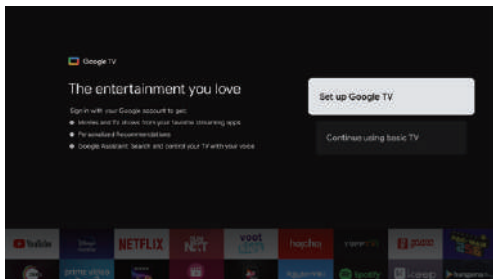

Selecione "Set up Google TV (Configurar Google TV)" e avance para o passo seguinte, introduza a sua conta e palavra-passe.

E siga as instruções para concluir as definições relevantes.

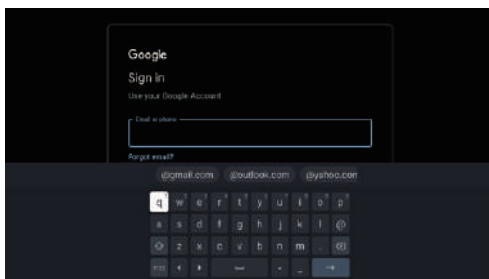

PRIVACIDADE

Menu->Settings->Privacy (Menu->Definições->Privacidade).

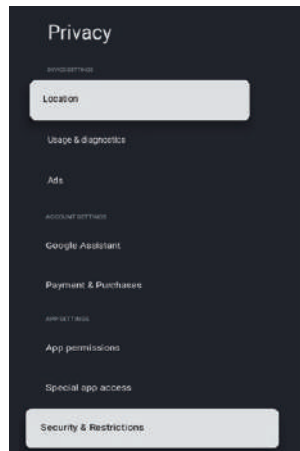

Neste menu, pode definir a localização, a utilização e o diagnóstico, etc. da TV.

1. Prima o botão ▲/▼ para selecionar o que pretende definir.
2. Prima o botão **OK** para confirmar.
3. Depois de terminar o ajuste, prima o botão **BACK** (VOLTAR) para regressar ao menu anterior.

LOCALIZAÇÃO

Menu->Settings->Privacy ->Location (Menu->Definições->Privacidade->Localização).

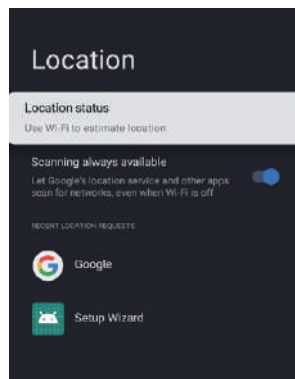

Location status (Estado da localização) – Prima o botão ▲/▼ para selecionar a opção e, em seguida, prima o botão **OK** para aceder ao sub-menu. (Opcional: Utilizar Wi-Fi para estimar a localização, Desligado)

Scanning always available (Pesquisa sempre disponível) – Prima o botão ▲/▼ para selecionar a opção e, em seguida, prima o botão **OK** para escolher LIGAR/DESLIGAR.

INSTRUÇÕES DE OPERAÇÃO

UTILIZAÇÃO E DIAGNÓSTICO

Menu->Settings->Privacy ->Usage & diagnostics
(Menu->Configurações->Privacidade ->Utilização e diagnóstico)

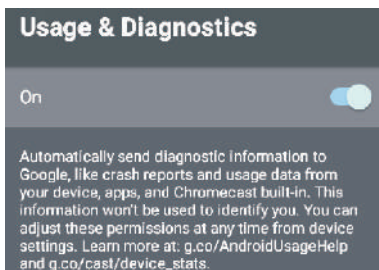

Usage & diagnostics (Utilização e diagnóstico) – Prima o botão ▲/▼ para seleccionar a opção e, em seguida, prima o botão OK para seleccionar LIGAR/DESLIGAR.

APLICAÇÕES

Menu->Settings->Apps (Menu->Definições->Aplicações).

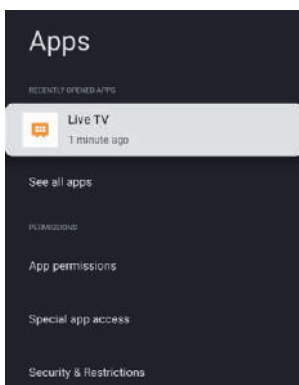

Neste menu, pode definir as permissões das aplicações e ler as listas de aplicações

1. Prima o botão ▲/▼ para seleccionar o que pretende definir.
2. Prima o botão OK para confirmar.
3. Depois de terminar o ajuste, prima o botão BACK (VOLTAR) para regressar ao menu anterior.

SISTEMA

Menu->Settings->System (Menu->Definições->Sistema).

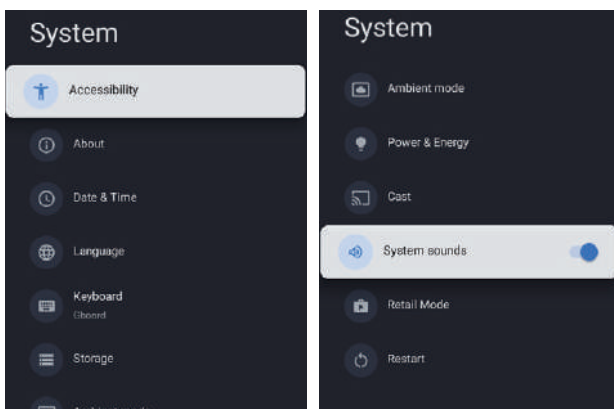

Neste menu, pode ler as informações e definições da TV.

1. Prima o botão ▲/▼ para seleccionar o que pretende definir.
2. Prima o botão OK para confirmar.
3. Depois de terminar o ajuste, prima o botão BACK (VOLTAR) para regressar ao menu anterior.

System sounds (Sons do sistema) – Prima o botão ▲/▼ para seleccionar a opção e, em seguida, prima o botão OK para seleccionar LIGAR/DESLIGAR. Para mais informações sobre o sistema, consulte a explicação seguinte.

ACESSIBILIDADE

Menu->Settings->System -> Accessibility (Menu->Definições->Sistema -> Acessibilidade).

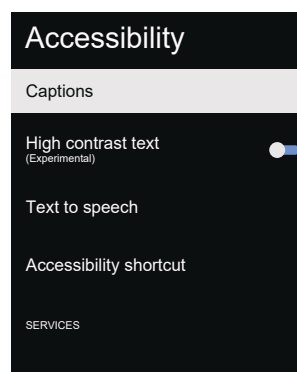

Captions (Legendas) – Prima o botão ▲/▼ para seleccionar a opção e, em seguida, prima o botão OK para entrar no sub-menu.

High contrast text (Texto de alto contraste) – Prima o botão ▲/▼ para seleccionar a opção e, em seguida, prima o botão OK para escolher LIGAR/DESLIGAR.

Text to speech (Texto para voz) – Prima o botão ▲/▼ para seleccionar a opção e, em seguida, prima o botão OK para aceder ao sub-menu.

Accessibility shortcut (Atalho de acessibilidade) – Prima o botão ▲/▼ para seleccionar a opção e, em seguida, prima o botão OK para aceder ao sub-menu.

SOBRE

Menu->Settings->System ->About (Menu->Definições->Sistema ->Sobre).

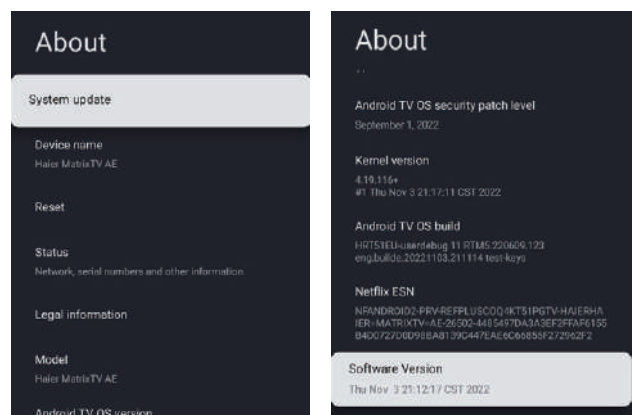

INSTRUÇÕES DE OPERAÇÃO

Neste menu, pode atualizar o sistema, repor e ler as informações da TV.

1. Prima o botão ▲/▼ para selecionar o que pretende definir.
2. Prima o botão OK para confirmar.
3. Depois de terminar o ajuste, prima o botão BACK (VOLTAR) para regressar ao menu anterior.

DATA E HORA

Menu->Settings->System -> Date & Time (Menu->Definições->Sistema -> Data e Hora).

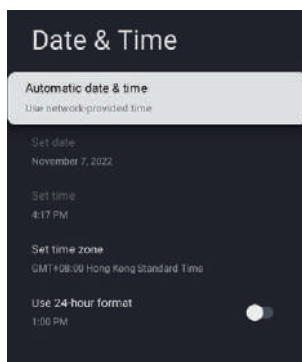

Automatic date & time (Data e hora automáticas)

– Prima o botão ▲/▼ para selecionar a opção e, em seguida, prima o botão OK para aceder ao sub-menu.

(Opcional: Utilizar a hora fornecida pela rede, Desligado)

NOTA

- Quando a opção Automatic date & time (Data e hora automáticas) está OFF (DESLIGADA), pode utilizar o ajuste manual da data e da hora.

Set date (Definir data) – Prima o botão ▲/▼ para selecionar a opção e, em seguida, prima o botão OK para aceder ao sub-menu.

Set time (Definir hora) – Prima o botão ▲/▼ para selecionar a opção e, em seguida, prima o botão OK para aceder ao sub-menu.

Set time zone (Definir o fuso horário) – Prima o botão ▲/▼ para selecionar a opção e, em seguida, prima o botão OK para aceder ao sub-menu.

Use 24-hour format (Utilizar o formato de 24 horas) – Prima o botão ▲/▼ para selecionar a opção e, em seguida, prima o botão OK para selecionar LIGAR/DESLIGAR.

LÍNGUA

Menu->Settings->System-> Language (Menu->Definições->Sistema-> Língua).

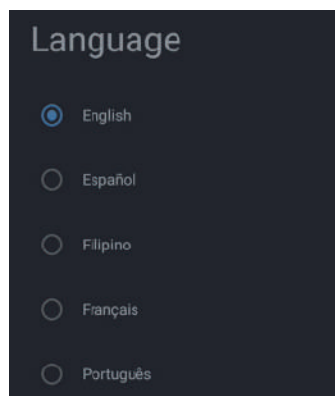

Language (Língua) – Prima o botão ▲/▼ para selecionar a opção e, em seguida, prima o botão OK para introduzir a língua selecionada.

TECLADO

Menu->Settings->System-> Keyboard (Menu->Definições->Sistema-> Teclado).

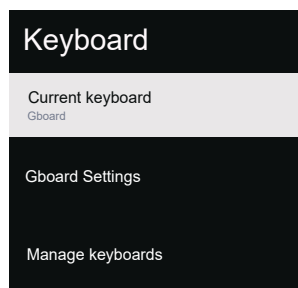

Current keyboard (Teclado atual) – Prima o botão ▲/▼ para selecionar a opção e, em seguida, prima o botão OK para aceder ao sub-menu.

Gboard Settings (Definições do Gboard) – Prima o botão ▲/▼ para selecionar a opção e, em seguida, prima o botão OK para aceder ao sub-menu.

Manage keyboards (Gerir teclados) – Prima o botão ▲/▼ para selecionar a opção e, em seguida, prima o botão OK para aceder ao sub-menu.

ARMAZENAMENTO

Menu->Settings->System->Storage (Menu->Definições->Sistema-> Armazenamento).

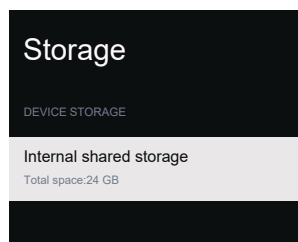

Internal shared storage (Armazenamento interno partilhado) – Prima o botão ▲/▼ para selecionar a opção e, em seguida, prima o botão OK para aceder ao sub-menu.

INSTRUÇÕES DE OPERAÇÃO

MODO AMBIENTE

Menu->Settings->System -> Ambient Mode (Menu->Definições->Sistema -> Modo ambiente).

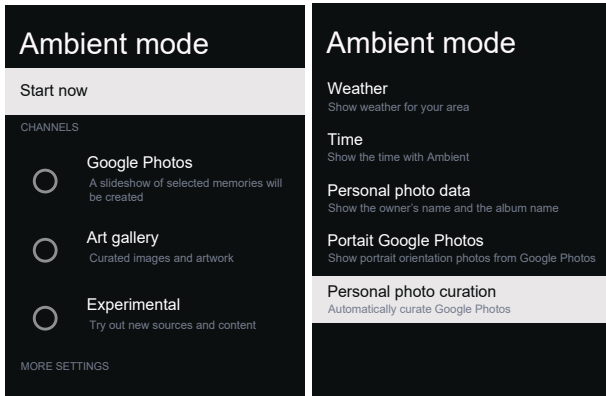

Neste menu, pode definir o modo ambiente.

1. Prima o botão ▲/▼ para seleccionar o que pretende definir.
2. Prima o botão OK para confirmar.
3. Depois de terminar o ajuste, prima o botão BACK (VOLTAR) para regressar ao menu anterior.

POTÊNCIA E ENERGIA

Menu->Settings-> System->Power & Energy (Menu->Definições->Sistema->Potência e Energia).

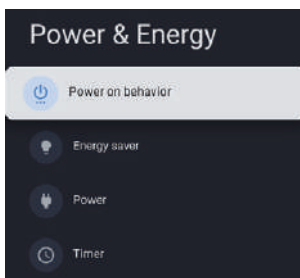

Neste menu, pode definir a alimentação e a energia. (comportamento ao ligar, poupança de energia, potência e temporizador)

1. Prima o botão ▲/▼ para seleccionar o que pretende definir.
2. Prima o botão OK para confirmar.
3. Depois de terminar o ajuste, prima o botão BACK (VOLTAR) para regressar ao menu anterior.

COMPORTAMENTO AO LIGAR

Menu->Settings-> System->Power & Energy->Power on behavior (Menu->Definições->Sistema->Potência e Energia->Comportamento ao ligar).

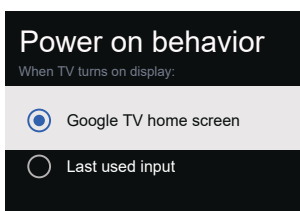

Prima o botão ▲/▼ para seleccionar a opção e, em seguida, prima o botão OK para confirmar.

POUPANÇA ENERGÉTICA

Menu->Settings-> System->Power & Energy ->Energy saver (Menu->Definições->Sistema->Potência e energia-> Poupança energética).

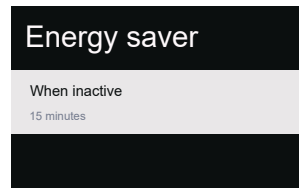

When inactive (Quando inativa) – Prima o botão ▲/▼ para seleccionar a opção e, em seguida, prima o botão OK para aceder ao sub-menu. (Opcional: 15 minutos, 20 minutos, 30 minutos, 1 hora, 4 horas, 8 horas, 12 horas, 24 horas, Nunca).

LIGAR/DESLIGAR

Menu->Settings-> System->Power & Energy->Power (Menu->Definições->Sistema->Potência e Energia->Ligar/Desligar).

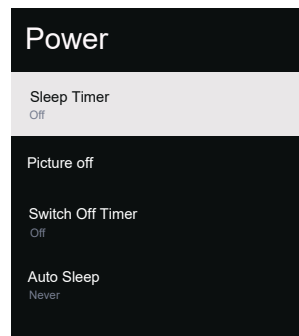

Sleep Timer (Temporizador de suspensão) – Prima o botão ▲/▼ para seleccionar a opção e, em seguida, prima o botão OK para aceder ao sub-menu. (Opcional: desligado, 10 minutos, 20 minutos, 30 minutos, 40 minutos, 50 minutos, 60 minutos, 90 minutos, 120 minutos)

Picture off (Imagem desligada) – Prima o botão ▲/▼ para seleccionar a opção e, em seguida, prima o botão OK para confirmar.

Switch off timer (Temporizador para desligar) – Prima o botão ▲/▼ para seleccionar a opção e, em seguida, prima o botão OK para aceder ao sub-menu.

(Opcional: desligado, 30 minutos, 60 minutos, 90 minutos, 120 minutos, 150 minutos, 180 minutos, 210 minutos, 240 minutos)

Auto Sleep (Suspensão automática) – Prima o botão ▲/▼ para seleccionar a opção e, em seguida, prima o botão OK para aceder ao sub-menu. (Opcional: Nunca, 4 horas, 6 horas 8 horas)

TEMPORIZADOR

(Menu->Settings-> System->Power & Energy->Timer) Menu->Definições->Sistema-> Potência e Energia->Temporizador

INSTRUÇÕES DE OPERAÇÃO

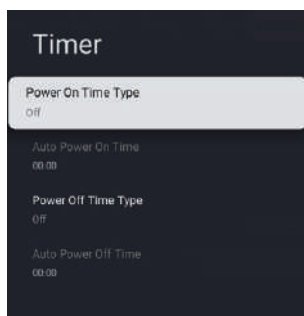

Power On Time Type (Tipo de tempo de ativação) – Prima o botão ▲/▼ para selecionar a opção e, em seguida, prima o botão OK para selecionar LIGAR/DESLIGAR/UMA VEZ.

Auto Power On Time (Tempo de ativação automática) – Prima o botão ▲/▼ para selecionar a opção e, em seguida, prima o botão OK para aceder ao sub-menu.

Power Off Time Type (Tipo de tempo de desativação) – Prima o botão ▲/▼ para selecionar a opção e, em seguida, prima o botão OK para escolher DESLIGAR/LIGAR/UMA VEZ.

Auto Power Off Time (Tempo de desligar automático) – Prima o botão ▲/▼ para selecionar a opção e, em seguida, prima o botão OK para aceder ao sub-menu.

TRANSMISSÃO

Menu->Settings->System-> Cast (Menu->Definições->Sistema-> Transmissão).

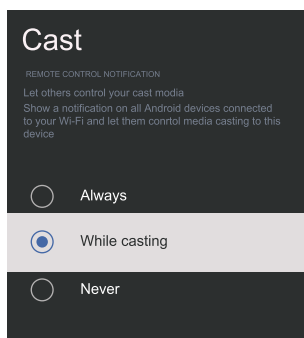

1. Prima o botão ▲/▼ para selecionar o que pretende definir.
2. Prima o botão OK para confirmar.
3. Prima o botão (BACK) MENU para voltar ao menu anterior.

MODO DE LOJA

Menu->Settings->System-> Retail Mode (Menu->Definições->Sistema-> Modo de loja).

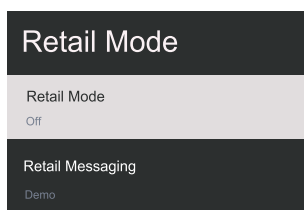

Retail mode (Modo de loja) – Prima o botão ▲/▼ para selecionar a opção e, em seguida, prima o

botão OK para selecionar LIGAR/DESLIGAR.

Retail messaging (Mensagens de vendas) – Prima o botão ▲/▼ para selecionar a opção e, em seguida, prima o botão OK para aceder ao sub-menu. (Nota: Demo, e-POP, e-POP + Demo)

REINICIAR

Menu->Settings->System-> Restart (Menu->Definições->Sistema->Reiniciar).

Prima o botão OK para aceder ao sub-menu. (Opcional: reiniciar e cancelar)

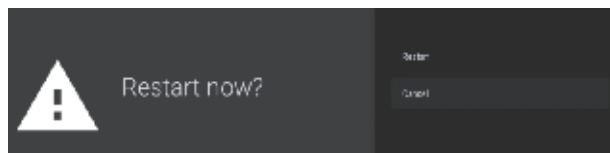

TELECOMANDOS E ACESSÓRIOS

Menu->Settings-> Remotes & Accessories (Menu->Definições-> Telecomandos e acessórios).

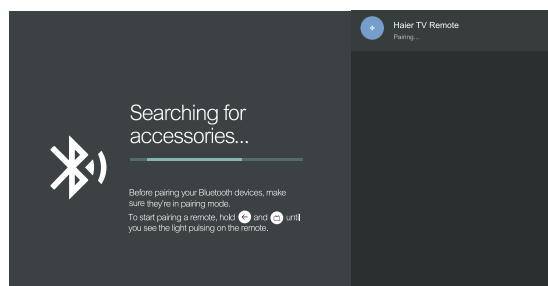
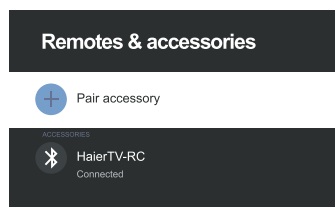

Neste menu, pode emparelhar dispositivos Bluetooth.

1. Prima os botões "←" e "⏏" na parte inferior do telecomando durante 5 segundos
2. Quando o LED começar a piscar, solte-o. O telecomando enviará o sinal de emparelhamento para a TV e apresentará as informações do telecomando no lado direito do ecrã.
3. Prima o botão OK para visualizar o emparelhamento. Se for apresentado emparelhado, a ligação foi efetuada com êxito.
4. Se aparecer a mensagem não foi possível emparelhar, a ligação falhou. Aguarde 30 segundos e, em seguida, prima os botões "←" e "⏏" na parte inferior do telecomando durante 5 segundos para repetir os passos anteriores.
5. Prima o botão "←" para voltar ao menu anterior.

INSTRUÇÕES DE OPERAÇÃO

UTILIZAR O MULTI MEDIA PLAYER

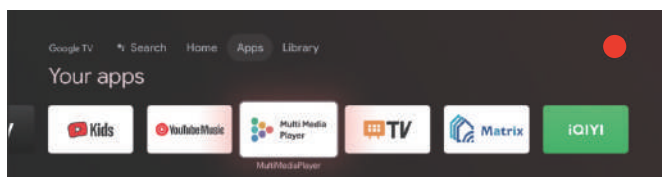

1. Na interface INÍCIO ou Aplicações, prima **▲/▼/◀/▶** para selecionar a aplicação Multi Media Player

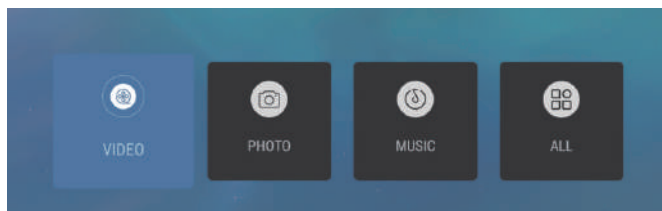

2. Selecione a tecla OK para entrar no Multi Media Player e visualizar Vídeo, Fotografia, Áudio. Depois de inserir a unidade flash usb, pode visualizar os ficheiros correspondentes na unidade flash usb (formato FAT32).

NOTA

O menu pode ser diferente consoante a data de aquisição do televisor.

RESOLUÇÃO DE PROBLEMAS

Efetue estas verificações simples antes de contactar a assistência técnica. Estas dicas podem poupar-lhe tempo e dinheiro, uma vez que os custos de instalação do recetor e os ajustes dos controlos do cliente não estão cobertos pela garantia.

Sintomas	Itens a verificar e ações a seguir
Imagem "fantasma" ou dupla	<ul style="list-style-type: none">Isto pode ser causado por obstrução da antena devido a edifícios altos ou montanhas. A utilização de uma antena altamente direcional pode melhorar a imagem.
Sem energia	<ul style="list-style-type: none">Verifique se o cabo de alimentação CA da TV está ligado à tomada.Desligue a TV, aguarde 60 segundos. Em seguida, volte a inserir a ficha na tomada e ligue novamente a TV.
Sem imagem	<ul style="list-style-type: none">Verifique as ligações da antena na parte de trás da TV para ver se está corretamente ligada à TV.Possível problema com a estação de transmissão. Tente outro canal.Ajuste as definições de contraste e de brilho.Verifique o controlo das legendas fechadas. Alguns modos de TEXTO podem bloquear o ecrã.
Boa imagem mas sem som	<ul style="list-style-type: none">Prima o botão MUTE no telecomando para garantir que o som está ligado.
Bom som mas pouca cor	<ul style="list-style-type: none">Ajuste as definições de contraste, cor e brilho.
Má imagem	<ul style="list-style-type: none">Pode ocorrer uma má qualidade de imagem quando uma câmara S-VHS ativada ou uma câmara de vídeo estiver ligada à TV e a outros periféricos ao mesmo tempo. Desligue um dos periféricos.
Imagem com aspeto de chuva e ruído	<ul style="list-style-type: none">Verifique a ligação da antena.
Linha pontilhada horizontal	<ul style="list-style-type: none">Esta situação pode ser causada por interferências elétricas (por exemplo, secador de cabelo, luzes de néon próximas, etc.) Desligue o equipamento.
O televisor não responde ao telecomando	<ul style="list-style-type: none">Verifique se as pilhas estão a funcionar. Substituir se necessário.Limpe a lente do sensor do telecomando na TV.
Pixeis (pontos) sempre escuros ou sempre iluminados	<ul style="list-style-type: none">A sua TV é fabricada com precisão, utilizando um nível de tecnologia extremamente elevado. No entanto, por vezes, os pixeis podem não ser apresentados corretamente. Estes tipos de ocorrências são inerentes a este tipo de produto e não constituem um produto defeituoso.

NOTA

- Este produto utiliza um painel constituído por sub pixeis que requerem tecnologia sofisticada para serem produzidos. No entanto, podem existir alguns pixeis claros ou escuros no ecrã. Estes pixeis não têm qualquer impacto no desempenho do produto.



Os termos HDMI, HDMI High-Definition Multimedia Interface, HDMI Trade dress e os logotipos HDMI são marcas comerciais ou marcas registadas da HDMI Licensing Administrator, Inc.



Dolby, Dolby Vision, Dolby Atmos, Dolby Audio e o símbolo duplo D são marcas registadas da Dolby Laboratories Licensing Corporation. Fabricado sob licença da Dolby Laboratories. Trabalhos não publicados confidenciais. Direitos de autor ©2012-2024 Dolby Laboratories. Todos os direitos reservados.

ESPECIFICAÇÃO DO PRODUTO

TV LED UHD de 43"

Qualidade de imagem da televisão:	UHD Digital integrado. Tamanho do ecrã: 108 cm Resolução 3840x2160 pixels 60 Hz.
Sistema de TV:	PAL-B/G, SECAM-B/G
Descodificador de sintonizador de DTV	DVB-T, DVB-C, DVB-T2, DVB-S2 Modulação 16/32/64/128/256 QAM MPEG2, MPEG4, H.265
Conetividade:	1 porta ótica 2 portas USB 1 LAN 4 tomadas HDMI 1 tomada VIDEO 1 tomada L 1 tomada R 2 tomadas RF 1 porta para AURICULAR 1 ranhura CI Sistemas suportados: PAL+SECAM Número de canais armazenados: 1000(DTV), 100(ATV) TV (RF): 75Ω Desequilíbrio Entrada de vídeo AV: 75 Ω, 1V-P, RCA Entrada de áudio AV: 20 KΩ, 500 mV RMS Entrada de vídeo HDMI: 480i, 480p, 720p, 1080i, 1080p, 2160p Wi-Fi: Norma: IEEE 802.11a/b/g/n/ac, Frequência: 2,4 GHz/5 GHz Bluetooth: V5.1
Qualidade do som:	Sistema de som estéreo. 2 x 10 watts RMS de potência de saída.
Consumo de energia em modo de espera	≤0,5 W
Funcionalidades digitais:	Digitalmente interativa. Texto digital. Legendas de difusão de vídeo digital (DVB) disponíveis. Configuração automática. Pesquisa automática de novos canais. Guia de programas atual e seguinte. Guia eletrónico de programas (EPG) de 7 dias. Ranhura CI. Compatível com a descrição áudio.
Funcionalidades adicionais:	Sintonizador UHF/VHF; Temporizador de suspensão; Orientação parental; Imagem e texto São necessárias 2 pilhas AAA para o telecomando. Tamanho do suporte VESA: 300x300 mm Tamanho da embalagem (LxAxP): 1075x652x142 mm Tamanho do conjunto (LxAxP) com suporte: 957,2x607,4x240,7 mm Tamanho do conjunto (LxAxP) sem suporte: 957,2x566,7x86,6 mm Peso da embalagem: 10 kg Peso do conjunto com suporte: 7,2 kg Peso do conjunto sem suporte: 6,8 kg

* As especificações dos componentes desta TV fornecidas aqui são apenas para referência. Podem ocorrer diferenças à medida que a tecnologia do produto é atualizada. Desenho e especificações estão sujeitas a alterações sem aviso prévio.

ESPECIFICAÇÃO DO PRODUTO

TV LED UHD de 50"

Qualidade de imagem da televisão:	UHD Digital integrado. Tamanho do ecrã: 126 cm Resolução 3840x2160 pixels 60 Hz.
Sistema de TV:	PAL-B/G, SECAM-B/G
Descodificador de sintonizador de DTV	DVB-T, DVB-C, DVB-T2, DVB-S2 Modulação 16/32/64/128/256 QAM MPEG2, MPEG4, H.265
Conetividade:	1 porta ótica 2 portas USB 1 LAN 4 tomadas HDMI 1 tomada VIDEO 1 tomada L 1 tomada R 2 tomadas RF 1 porta para AURICULAR 1 ranhura CI Sistemas suportados: PAL+SECAM Número de canais armazenados: 1000(DTV), 100(ATV) TV (RF): 75 Ω Desequilíbrio Entrada de vídeo AV: 75 Ω, 1V-P, RCA Entrada de áudio AV: 20 KΩ, 500 mV RMS Entrada de vídeo HDMI: 480i, 480p, 720p, 1080i, 1080p, 2160p Wi-Fi: Norma: IEEE 802.11 a/b/g/n/ac, Frequência: 2,4 GHz/5 GHz Bluetooth: V5.1
Qualidade do som:	Sistema de som estéreo. 2 x 13.5 watts RMS de potência de saída.
Consumo de energia em modo de espera	≤0,5 W
Funcionalidades digitais:	Digitalmente interativa. Texto digital. Legendas de difusão de vídeo digital (DVB) disponíveis. Configuração automática. Pesquisa automática de novos canais. Guia de programas atual e seguinte. Guia eletrónico de programas (EPG) de 7 dias. Ranhura CI. Compatível com a descrição áudio.
Funcionalidades adicionais:	Sintonizador UHF/VHF; Temporizador de suspensão; Orientação parental; Imagem e texto São necessárias 2 pilhas AAA para o telecomando. Tamanho do suporte VESA: 300x300 mm Tamanho da embalagem (LxAxP): 1250x760x144 mm Tamanho do conjunto (LxAxP) com suporte: 1111,2x710,5x277,2 mm Tamanho do conjunto (LxAxP) sem suporte: 1111,2x651,8x88 mm Peso da embalagem: 13,5 kg Peso do conjunto com suporte: 10 kg Peso do conjunto sem suporte: 9,5 kg

* As especificações dos componentes desta TV fornecidas aqui são apenas para referência. Podem ocorrer diferenças à medida que a tecnologia do produto é atualizada. Desenho e especificações estão sujeitas a alterações sem aviso prévio.

ESPECIFICAÇÃO DO PRODUTO

TV LED UHD de 55"

Qualidade de imagem da televisão:	UHD Digital integrado. Tamanho do ecrã: 139 cm Resolução 3840x2160 pixels 60 Hz.
Sistema de TV:	PAL-B/G, SECAM-B/G
Descodificador de sintonizador de DTV	DVB-T, DVB-C, DVB-T2, DVB-S2 Modulação 16/32/64/128/256 QAM MPEG2, MPEG4, H.265
Conetividade:	1 porta ótica 2 portas USB 1 LAN 4 tomadas HDMI 1 tomada VIDEO 1 tomada L 1 tomada R 2 tomadas RF 1 porta para AURICULAR 1 ranhura CI Sistemas suportados: PAL+SECAM Número de canais armazenados: 1000(DTV), 100(ATV) TV (RF): 75Ω Desequilíbrio Entrada de vídeo AV: 75 Ω, 1V-P, RCA Entrada de áudio AV: 20 KΩ, 500 mV RMS Entrada de vídeo HDMI: 480i, 480p, 720p, 1080i, 1080p, 2160p Wi-Fi: Norma: IEEE 802.11a/b/g/n/ac, Frequência: 2,4 GHz/5 GHz Bluetooth: V5.1
Qualidade do som:	Sistema de som estéreo. 2 x 13,5 watts RMS de potência de saída.
Consumo de energia em modo de espera	≤0,5 W
Funcionalidades digitais:	Digitalmente interativa. Texto digital. Legendas de difusão de vídeo digital (DVB) disponíveis. Configuração automática. Pesquisa automática de novos canais. Guia de programas atual e seguinte. Guia eletrónico de programas (EPG) de 7 dias. Ranhura CI. Compatível com a descrição áudio.
Funcionalidades adicionais:	Sintonizador UHF/VHF; Temporizador de suspensão; Orientação parental; Imagem e texto São necessárias 2 pilhas AAA para o telecomando. Tamanho do suporte VESA: 300x300 mm Tamanho da embalagem (LxAxP): 1350x837x144 mm Tamanho do conjunto (LxAxP) com suporte: 1225,8x777,3x277,2 mm Tamanho do conjunto (LxAxP) sem suporte: 1225,8x719,4x88,1 mm Peso da embalagem: 16,4 kg Peso do conjunto com suporte: 11,9 kg Peso do conjunto sem suporte: 11,4 kg

* As especificações dos componentes desta TV fornecidas aqui são apenas para referência. Podem ocorrer diferenças à medida que a tecnologia do produto é atualizada. Desenho e especificações estão sujeitas a alterações sem aviso prévio.

ESPECIFICAÇÃO DO PRODUTO

TV LED UHD de 65"

Qualidade de imagem da televisão:	UHD Digital integrado. Tamanho do ecrã: 164 cm Resolução 3840x2160 pixels 60 Hz.
Sistema de TV:	PAL-B/G, SECAM-B/G
Descodificador de sintonizador de DTV	DVB-T, DVB-C, DVB-T2, DVB-S2 Modulação 16/32/64/128/256 QAM MPEG2, MPEG4, H.265
Conetividade:	1 porta ótica 2 portas USB 1 LAN 4 tomadas HDMI 1 tomada VIDEO 1 tomada L 1 tomada R 2 tomadas RF 1 porta para AURICULAR 1 ranhura CI Sistemas suportados: PAL+SECAM Número de canais armazenados: 1000(DTV), 100(ATV) TV (RF): 75 Ω Desequilíbrio Entrada de vídeo AV: 75 Ω, 1V-P, RCA Entrada de áudio AV: 20 KΩ, 500 mV RMS Entrada de vídeo HDMI: 480i, 480p, 720p, 1080i, 1080p, 2160p Wi-Fi: Norma: IEEE 802.11 a/b/g/n/ac, Frequência: 2,4 GHz/5 GHz Bluetooth: V5.1
Qualidade do som:	Sistema de som estéreo. 2 x 13,5 watts RMS de potência de saída.
Consumo de energia em modo de espera	≤0,5 W
Funcionalidades digitais:	Digitalmente interativa. Texto digital. Legendas de difusão de vídeo digital (DVB) disponíveis. Configuração automática. Pesquisa automática de novos canais. Guia de programas atual e seguinte. Guia eletrónico de programas (EPG) de 7 dias. Ranhura CI. Compatível com a descrição áudio.
Funcionalidades adicionais:	Sintonizador UHF/VHF; Temporizador de suspensão; Orientação parental; Imagem e texto São necessárias 2 pilhas AAA para o telecomando. Tamanho do suporte VESA: 400x300 mm Tamanho da embalagem (LxAxP): 1600x960x164 mm Tamanho do conjunto (LxAxP) com suporte: 1446,4x904,7x313,8 mm Tamanho do conjunto (LxAxP) sem suporte: 1446,4x841,3x85,1 mm Peso da embalagem: 24 kg Peso do conjunto com suporte: 17,2 kg Peso do conjunto sem suporte: 16,5 kg

* As especificações dos componentes desta TV fornecidas aqui são apenas para referência. Podem ocorrer diferenças à medida que a tecnologia do produto é atualizada. Desenho e especificações estão sujeitas a alterações sem aviso prévio.

Haier

Haier

Stil de viață inspirat

Manual de
utilizare

Model:

H43Q80FUX

H50Q80FUX

H55Q80FUX

H65Q80FUX



Ilustrațiile din acest ghid sunt oferite doar în scop ilustrativ și pot diferi de aspectul real al produsului.

Designul și specificațiile produsului pot fi modificate fără înștiințarea în prealabil.

Televiziune LED

CUPRINS

1. INSTRUCȚIUNI SIGURANȚĂ IMPORTANTE.....	1
2. PREGĂTIREA.....	3
3. CONEXIUNI PERIFERICE ȘI CONTROALE.....	4
4. EFECTUAREA CONEXIUNILOR.....	5
5. INSTRUCȚIUNI DE UTILIZARE.....	6
6. DEPANARE.....	18
7. SPECIFICAȚIILE PRODUSULUI	19



Ilustrațiile din acest ghid sunt oferite doar în scop ilustrativ și pot diferi de aspectul real al produsului. Designul și specificațiile produsului pot fi modificate fără înștiințarea în prealabil.

INSTRUȚIUNI SIGURANȚĂ IMPORTANTE

- 1) Citiți cu atenție aceste instrucțiuni.
- 2) Mențineți aceste instrucțiuni.
- 3) Țineți cont de toate avertismentele.
- 4) Respectați toate instrucțiunile.
- 5) Nu utilizați acest produs în apropierea apei.
- 6) Curățați doar cu o cârpă uscată.
- 7) Nu blocați orificiile de ventilație, montați în conformitate cu instrucțiunile.
- 8) Nu montați lângă orice surse de căldură cum ar fi radiatoarele, centrale termice, aragaze sau alte tipuri de aparatură (incluzând amplificatoare) producătoare de căldură.
- 9) Nu dezactivați caracteristicile de siguranță ale ștecherului polarizat. Dacă ștecherul furnizat nu se potrivește cu priza, consultați un electrician pentru înlocuirea corespunzătoare a prizei vechi.
- 10) Protejați cablul de alimentare de a fi călcat sau strâns în special la prize, orificiile convenabile și în punctul de unde acestea ies din aparat.
- 11) Utilizați doar atașamentele/accesoriile specificat de către producător.
- 12) Deconectați aparatul în timpul furtunilor electrice sau în momentul când nu este utilizat pentru o perioadă lungă de timp.
- 13) Consultați personal calificat pentru orice operațiuni de întreținere. Servisarea este necesară în momentul când aparatul a fost avariat în orice fel, cum ar fi cablul de alimentare sau ștecherul este avariat, lichid a fost vărsat sau obiecte au căzut în aparat, aparatul a fost expus unei ploii sau umezelii, nu funcționează normal sau a fost scâpat.
- 14) Ștecherul de alimentare este utilizat ca dispozitiv de deconectare, dispozitivul de deconectare va rămâne operațional.
- 15) Ventilarea nu trebuie împiedicată prin acoperirea orificiilor de ventilare cu obiecte precum ziare, fețe de masă, perdele etc.
- 16) Fără surse de foc deschis cum ar fi lumânările aprinse, trebuie să fie plasate pe aparat.
- 17) Trebuie să aveți un grad mare de atenție la aspectul de mediu referitor la reciclarea bateriei.
- 18) Utilizarea aparatului în climat moderat.
- 19) Aparatul nu va fi expus la picături sau stropiri cu lichide și niciun obiect umplut cu lichide, cum ar fi, nu va fi pus pe aparat.
- 20) Avertisment: Pentru evitarea oricărei vătămări cauzate de înclinarea produsului, vă rugăm să vă asigurați întotdeauna că produsul a fost plasat pe o suprafață orizontală.

*** Produsul actual poate diferi ca aspect ca imaginea de mai sus**

În cazul în care un ștecher pe cablul de alimentare este utilizat ca dispozitiv de deconectare, instrucțiunile de montaj vor evidenția acel echipament de încărcare, priza de ieșire va fi ușor accesibilă.

	ATENȚIE RIISC DE ȘOC ELECTRIC NU DESCHIDEȚI	
ATENȚIE PENTRU A REDUCE RISCUL DE ȘOC ELECTRIC, NU SCOATEȚI PROTECȚIA (SAU PARTEA POSTERIOARĂ) NU SUNT COMPONENTE SERVISABILE DE CĂTRE UTILIZAT ÎN INTERIOR. CONSULTAȚI PERSONAL CALIFICAT PENTRU OPERAȚIUNI DE SERVISARE.		



Simbolul indică că tensiunea periculoasă constituie un risc de șoc electric și este prezent în cadrul acestui aparat.



Acest simbol indică faptul că există instrucțiuni importante de utilizare și întreținere în manualul cu care produsul este acompania.

AVERTISMENT:

Pentru a reduce pericolul de incendiu sau de electrocutare, nu expuneți aparatul la ploaie sau umezeală.

AVERTISMENT:

Bateriile nu trebuie expuse la o sursă de căldură excesivă, cum ar fi la lumina solară, foc sau surse asemănătoare.



Acest simbol indică faptul că acest produs încorporează o izolație dblă între tensiunea principală periculoasă și componentele accesibile de către utilizator. În momentul servisirii, utilizați doar componente identice de înlocuire.



Acest simbol indică faptul că acest produs nu trebuie eliminat împreună cu alte deșeuri provenite din gospodărie. Pentru prevenirea posibilului pericol al mediului înconjurător sau sănătății umane de la eliminarea necontrolată a deșeurilor, reciclați-l responsabil pentru a promova o reutilizare sustenabilă a resurselor. Pentru a returna dispozitivul dvs. utilizat, vă rugăm să utilizați sistemul de returnare și de colectare sau contactați retailerul de unde a fost achiziționat produsul. Aceștia pot lua produsul pentru a efectua o reciclare în siguranță.

INSTRUȚIUNI SIGURANȚĂ IMPORTANTE

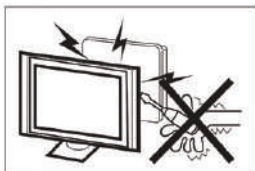

Tensiunea înaltă este utilizată pentru funcționarea acestui receptor de televizor. Nu scoateți partea posterioară a dulapului din set. Consultați personal calificat pentru operațiuni de servisare.

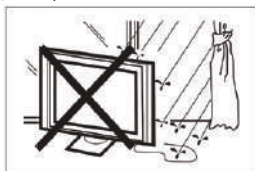

Pentru a preveni pericolul de incendiu sau șoc electric, nu expuneți receptorul televizorului la umezeală sau ploaie.



Nu săpați sau împingeți obiecte în deschiderile sau orificiile televizorului. Nu stropiți niciodată cu orice fel de lichid receptorul televizorului.



Nu blocați orificiile de ventilare din panoul posterior. Ventilația adecvată este esențială pentru a preveni defecțiunea componentelor electrice.



Nu prindeți cablul de alimentare sub receptorul televizorului.



Dacă doriți să curățați produsul. Deconectați televizorul, utilizați o cârpă moale, fără apă și fără substanțe chimice.



Nu stați pe, sprijinii sau împingeți în televizor sau pe standul acestuia. Trebuie să aveți grijă specială față de copiii. Dacă acesta cade, poate rezulta vătămări serioase.

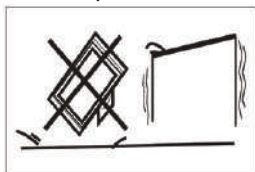

Nu așezați acest produs pe un cărucior instabil, pe un suport, raft sau pe masă. Vătămările periculoase către un individ, și avariile televizorului, poate rezulta dacă televizorul cade.

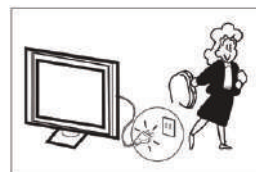

În momentul când receptorul nu este utilizat pentru o îndelungată perioadă de timp, este indicat să deconectați cablul de alimentare din priză de alimentare.

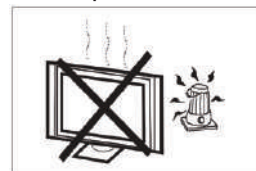

Nu expuneți receptorul televizorului la lumina directă a soarelui și la alte surse de căldură. Nu plasați receptorul televizorului direct pe alte produse care degajă căldură cum ar fi casetofone și amplificatoare audio. Nu plasați surse deschise de foc, cum ar fi lumânările aprinse pe televizor.

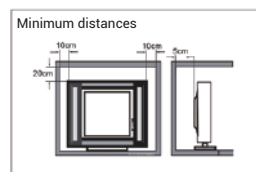

Dacă televizorul urmează a fi construit într-un compartiment sau un compartiment similar, distanțele minime trebuie să fie menținute. Acumularea de căldură poate reduce durata de viață a televizorului, și de asemenea, poate fi periculos.

Notă; utilizarea aparturii în climate moderate.

Atenție:

Televizorul poate să cadă, provocând vătămări corporale grave sau deces. Multe accidentări, în special ale copiilor, pot fi evitate prin luarea unor măsuri de precauție simple, precum:

- Utilizați ÎNTOTDEAUNA dulapuri, suporturi sau metode de montare recomandate de producătorul televizorului.
- ÎNTOTDEAUNA folosiți un mobilier care poate sprijini televizorul în condiții de siguranță.
- Asigurați-vă că televizorul nu depășește marginea mobilierului de susținere.
- ÎNTOTDEAUNA instruiți copiii cu privire la pericolele care apar dacă se urcă pe mobilier pentru a ajunge la televizor sau la butoanele acestuia.
- Așezați ÎNTOTDEAUNA cablurile conectate la televizor, astfel încât să nu existe pericol de împiedicare, tragere sau prindere.
- Nu așezați niciodată televizorul într-un loc instabil.
- NICIODATĂ nu așezați televizorul pe o piesă de mobilier înaltă (de exemplu, dulapuri sau biblioteci), fără a ancora atât piesa de mobilier cât și televizorul pe un suport adecvat.
- NICIODATĂ nu așezați televizorul pe o țesătură sau alte materiale aflate între televizor și mobilierul de susținere.
- Nu așezați NICIODATĂ obiecte care ar putea tenta copiii să se cațere, precum jucării și telecomenzi, pe televizor sau pe mobilierul pe care este amplasat televizorul.

Dacă televizorul existent este păstrat și mutat, trebuie aplicate aceleași recomandări ca mai sus.

PREGĂTIREA

IMPORTANT: Nu aplicați presiune pe afișajul ecranului deoarece poate compromite integritatea ecranului. Garanția producătorului nu acoperă abuzul operatorului sau montajul necorespunzător.

PRINDEREA STANDULUI

IMPORTANT: Standul acestui televizor trebuie să fie asamblat înainte de utilizare.

1. Amplasați unitatea televizorului cu fața în jos pe o suprafață moale și dreaptă (pătură, spumă, cârpfă, etc) pentru a preveni avariarea televizorului.
2. Fixați standul în partea inferioară a televizorului cu ajutorul a 6 șuruburi.

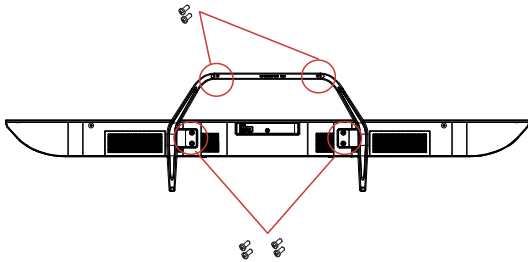

! NOTĂ

Aspectul produsului va fi în concordanță.

PREGĂTIREA TELEVIZORUL LED PENTRU MONTAJUL PE PERETE

Noi sugerăm să mențineți televizorul la o distanță de cel puțin 2.36 inci (60 mm) de perete pentru a preveni interferența cablului. Înainte de montarea televizorului pe perete, trebuie să scoateți standul.

Pentru siguranța vs, vă rugăm să-l folosiți cu un UI prnzat. suport de montaj p prt u o greutate minimă a televizorului fără stand

Pentru a monta un suport de montaj pe perete la televizorul dvs.

1. Eliminați șuruburile care mențin televizorul de stand.
2. Scoateți standul de pe televizor.
3. Securizați suportul de montaj pe perete în spatele televizorului utilizând patru șuruburi. Respectați instrucțiunile furnizate în manualul de utilizare care au venit împreună cu suportul de montaj pe perete.

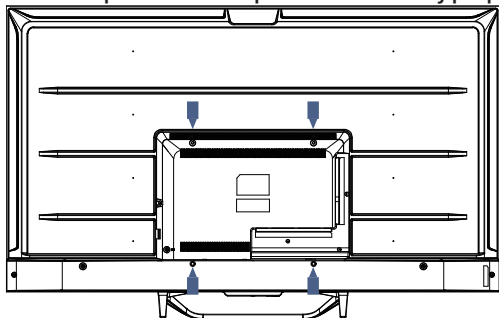

! NOTĂ

Suportul de montaj pe perete nu este inclus.

4. Fixați șuruburile de montaj pe perete (M6x12mm/4buc) în partea posterioară a televizorului LED, utilizând un cuplu de 12kgf,cm.

PORNIREA TELEVIZORULUI

1. Montați standul și plasați televizorul pe o suprafață solidă.

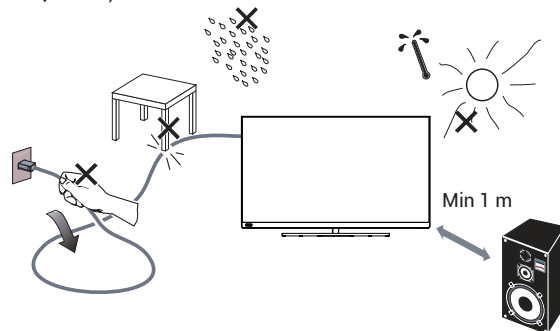

! NOTĂ

- Asigurați-vă că televizorul este plasat într-o poziție pentru a permite curgerea liberă a aerului. Nu acoperiți orificiile de ventilare aflate pe partea din spate.
- Pentru a preveni orice situații nedorite, fără surse de foc deschis, cum ar fi lumânările aprinse, acestea trebuie să fie plasate pe sau în vecinătate.
- Evitați căldura, razele solare directe și expunerea la ploaie sau apă. Echipamentul nu trebuie să fie expus la picături sau aruncări.

2. Conectați cablul antenei sau cablul televizorului în intrarea denumită **ANT IN** aflat în partea posterioară a televizorului.

3. Telecomandă:

Scoateți protecția aferentă compartimentului bateriei. Introduceți 2 baterii (Tip AAA 1.5V).

ATENȚIE: Risc de explozie dacă bateria este înlocuită cu una de un tip incorect.

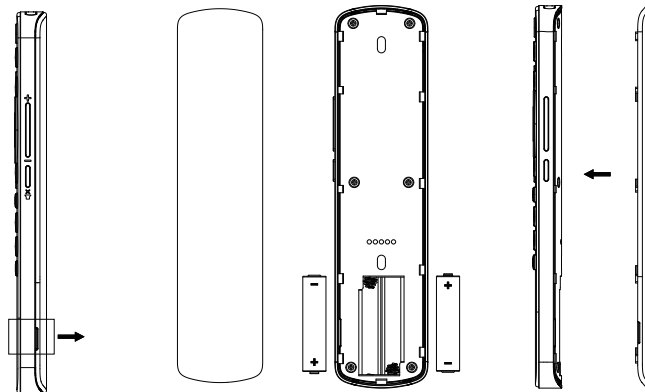

4. Pornire:

Conectați cablul într-o priză funcțională.

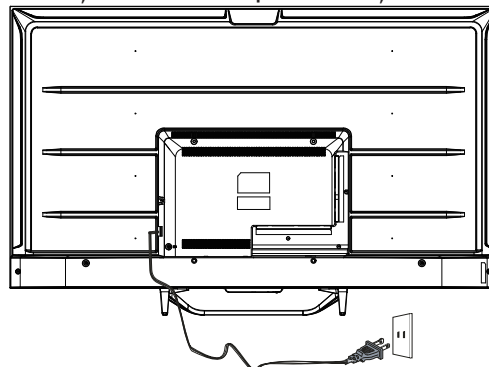

5. Porniți televizorul.

Apăsați **⏻** pe telecomandă sau butonul **POWER** pe partea laterală a panoului de control al televizorului.

CONEXIUNI PERIFERICE ȘI CONTROALE

CONTROL BUTON

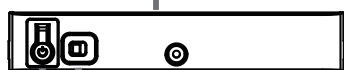
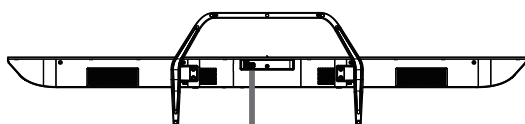
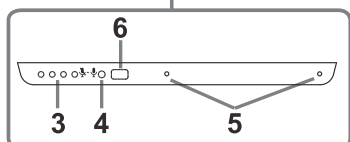
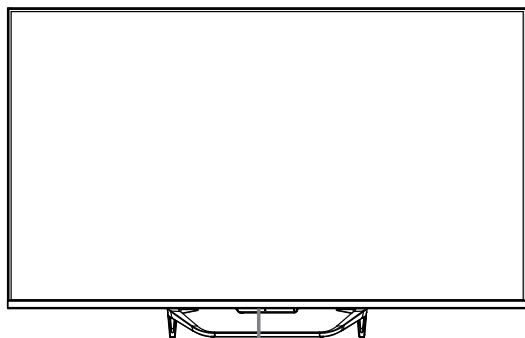

1 2

1. Pornire/Oprire
2. Voce pornit / Voce oprit
 - Activați Asistentul Far Field
 - Dezactivați Asistentul Far Field

Rotiți-l spre dreapta pentru a-l seta în poziția Pornit, lumina indicatorului se va aprinde și apoi se va stinge, funcția de voce a fost inițializată, dvs. puteți rosti cuvintele _Ok Google_ pentru a utiliza funcția de voce, iar indicatorul se va aprinde în momentul când televizorul primește un semnal de voce, apoi va repeta direct solicitarea dvs.

Rotiți-l spre stânga pentru a-l Opri pentru a ieși din funcția vocală, lumina indicatorului va deveni galbenă.

3. Lumină Asistent Far Field
4. Receptor semnal telecomandă
5. Receptor semnal voce
6. LED de alimentare

NOTĂ
Asigurați-vă că televizorul este conectat la internet înainte să utilizați Vocea.
Vă rugăm să-l setați în poziția Pornit înainte de a utiliza Vocea.
Vă rugăm să vă conectați la contul dvs. GOOGLE înainte de a utiliza Vocea.

ACCESORII

Telecomandă - 1 buc
Manual utilizator - 1 buc
Șuruburi - 6 buc
Ghid de pornire rapidă - 1 buc
Garanție - 1 buc

CONEXIUNEA COMPONENTELOR PERIFERICE



Toate terminalele sunt (de la stânga la dreapta)
LAN, OPTICAL, VIDEO, L, R, HDMI4, HDMI3, HDMI2,



Toate terminalele sunt (de la stânga la dreapta)
HDMI1 (eARC/ARC), LNB IN (SATELIT), ANT IN (ANTENĂ/CABLU), USB1, USB2, CĂȘTI, CI.

EFECTUAREA CONEXIUNILOR

ECHIPAMENT AV

Acest televizor furnizează un grup de AV pentru conectarea convenabil la VCR; DVD sau alte echipamente video.

Vă rugăm să consultați manualul utilizatorului care urmează a fi conectat.

Dvs. puteți utiliza terminalele de intrare poziționate în partea posterioară a televizorului după cum urmează.

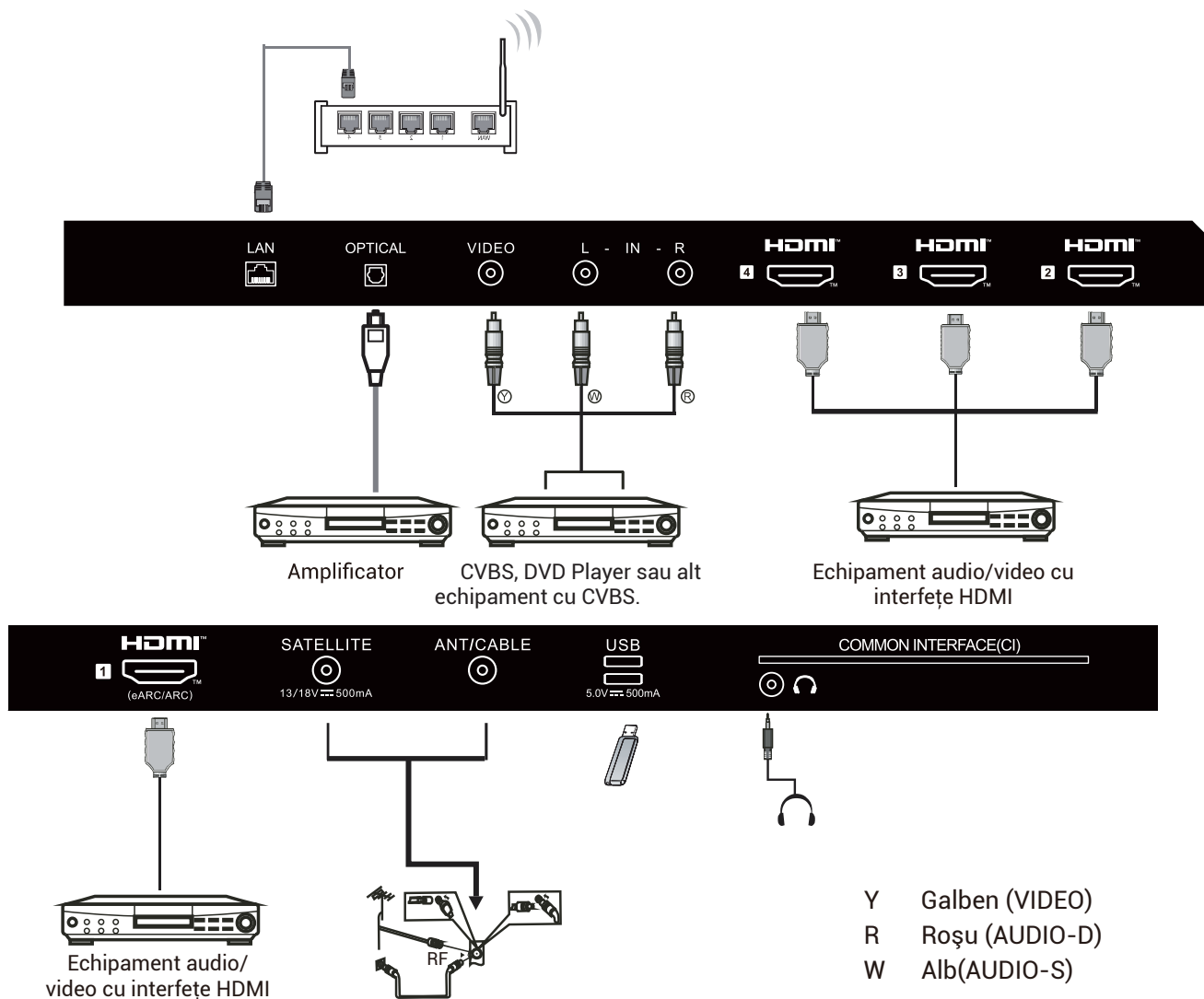

Acesta poate fi conectat la următoarele echipamente: VCR, multi disc player, DVD, camcorder, video game or stereo system, etc....

Notă:

Câteodată acesta nu va suporta în dispozitive diferite deoarece dispozitivul furnizează semnal non-standard.

INSTRUCȚIUNI DE UTILIZARE

UTILIZAREA TELECOMENZII

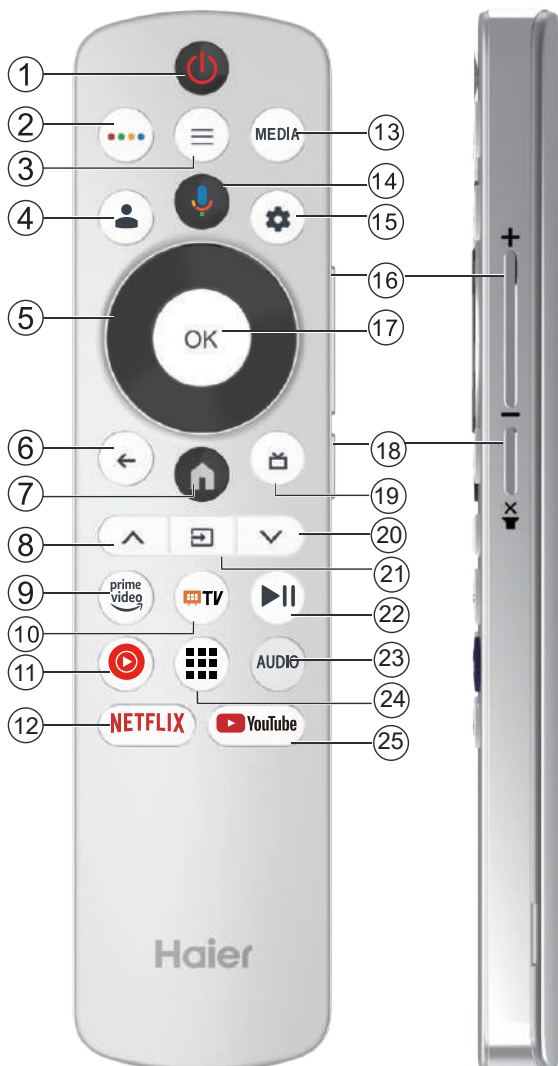

#	Element	Descriere
1	 Alimentare	Apăsați pentru a porni sau opri televizorul. În momentul când televizorul este oprit, alimentarea încă este transmisă prin echipament. Pentru a deconecta complet alimentarea, deconectați cablul de alimentare.
2		Apăsați pentru a deschide MAGIC BOARD.
3		Apăsați pentru a deschide sau închide meniul de pe ecran.
4		Apăsați pe meniul Conturi&Conectare la Google TV (În momentul stabilirii televizorului, această cheie nu are niciun efect)
5		Apăsați pentru a naviga prin meniul de pe ecran.
6		Reveniți la meniul anterior.
7		Apăsați pentru a deschide Pagina de Început.
8		Apăsați pentru a schimba canalele.
9		Apăsați pentru prime video pentru a vizualiza online programele TV și filmele (este necesar internet)
10		Apăsați pentru a deschide Live TV.
11		Apăsați pentru a deschide YouTube Music.
12		Apăsați pentru a deschide NETFLIX.
13		Apăsați pentru a deschide Multi Media Player.
14		Apăsați pentru a deschide Asistentul Google sau pentru a porni căutarea vocală.
15		Apăsați pentru a deschide meniul Setări.
16	VOL+VOL-	Apăsați butoanele VOL+ sau VOL- pentru a regla nivelul audio.
17	OK	Introduceți opțiunea selectată sau efectuați operațiunea selectată.
18		Apăsați pentru a activa sau a dezactiva sunetul.
19		Apăsați pentru a afișa ghidul electronic de program în modul televizor.
20		Apăsați pentru a schimba canalele.
21		Apăsați pentru a deschide lista de intrare a sursei.
22		Apăsați pentru a rula/pune pe pauză în modul multimedia.
23	AUDIO	Apăsați pentru a comuta între piesele audio.
24		Apăsați pentru a deschide aplicațiile.
25		Apăsați pentru a deschide YouTube.

INSTRUCȚIUNI DE UTILIZARE

CONFIGURAȚIE INIȚIALĂ

Prima dată când deschideți televizorul, expertul de configurare vă va ghida prin efectuarea setărilor de bază.

Faceți referire la Sfatul de text la Configurarea pentru prima dată.



Această funcție este utilizată pentru codul de asociere al telecomenzii. După ce acest cod este introdus cu succes, dvs. puteți utiliza telecomanda prin Bluetooth pentru a utiliza televizorul.

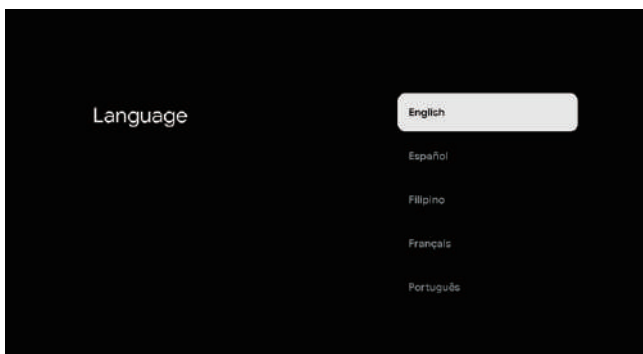

Apăsați tastele ▲/▼ pentru a selecta limba sistemului și apăsați butonul OK pentru a confirma imba.

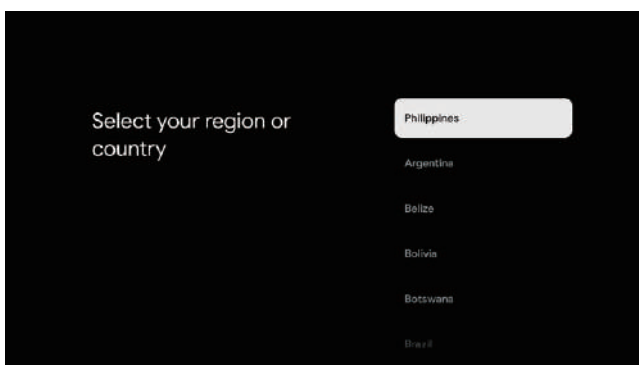

Apăsați tastele ▲/▼ pentru a selecta regiunea/țara dispozitivului și apoi apăsați butonul OK pentru a confirma.

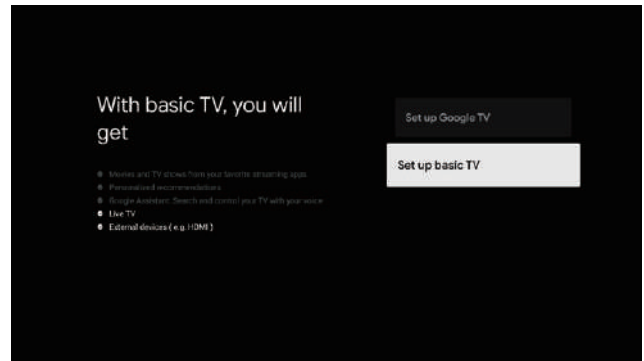

Apăsați tastele ▲/▼ pentru a selecta opțiunea "Set up basic TV (Stabilire televizor)" al dispozitivului și apăsați butonul OK pentru a finaliza configurarea.

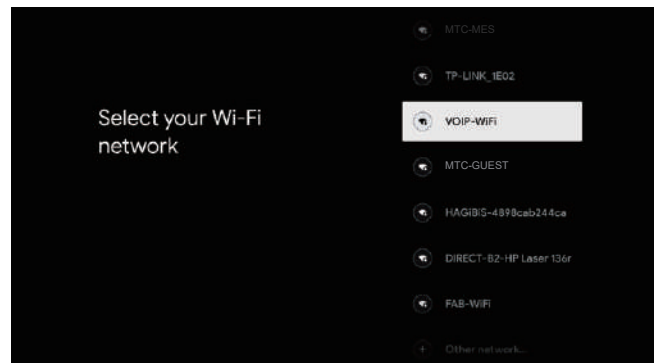

Apăsați tastele ▲/▼ pentru a selecta rețeaua wifi pentru a vă conecta, apăsați butonul OK pentru a introduce parola pentru a confirma că conexiunea este efectuată cu succes.

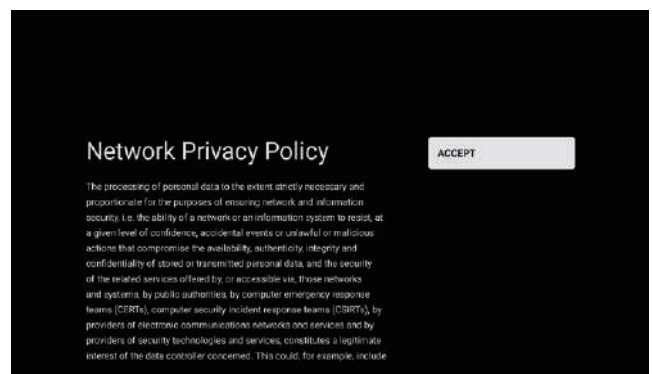

Selectați opțiunea "Accept (Acceptă)" pentru a accepta acești termeni ai Politicii de confidențialitate ai rețelei.

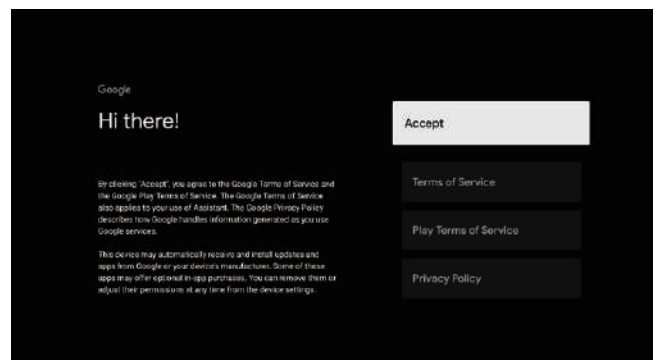

INSTRUCȚIUNI DE UTILIZARE

Acceptând Termenii de serviciu ai Google pentru a îmbunătăți experiența produsului, selectați opțiunea "Accept (Acceptă)" pentru a accepta această condiție.

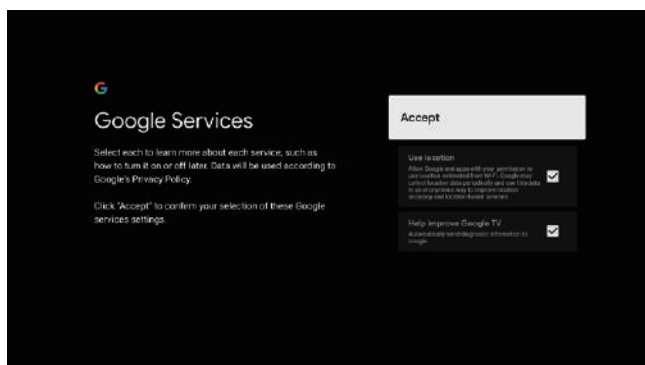

Prin acceptarea Serviciilor Google pentru a îmbunătăți experiența produsului, selectați opțiunea "Acceptă" pentru a accepta această condiție.

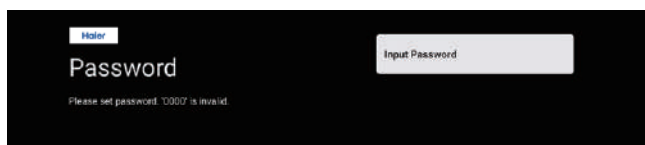

Utilizat pentru a seta parola dispozitivului pentru a asigura siguranță și confidențialitatea.

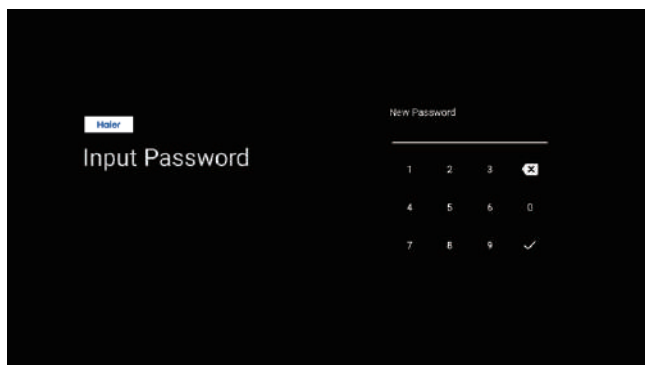

Utilizați telecomanda/tastatura pentru a introduce automat parola de 4 cifre pentru a sări automat la următoarea interfață.

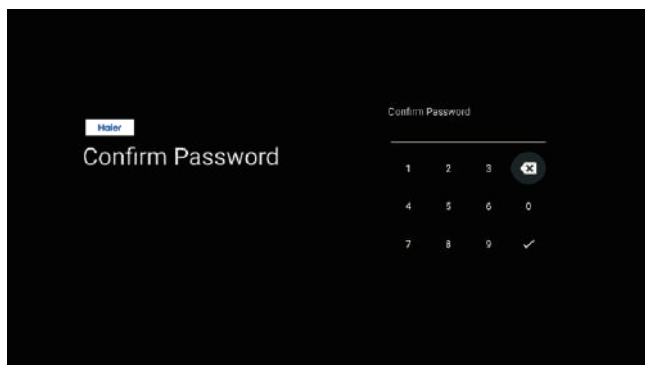

Confirmați parola din nou și mențineți-o. Utilizați în mod consistent telecomanda / tastatura pentru a introduce parola și de a finaliza parola.

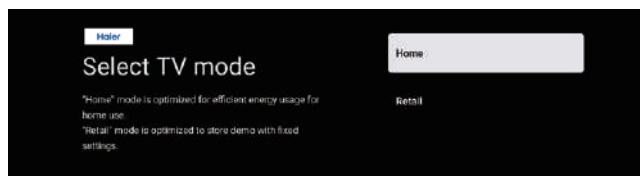

Pentru selectarea modului, apăsați tasta ▲/▼ pentru a selecta Modul Home (Acasă) și apoi apăsați tasta OK.

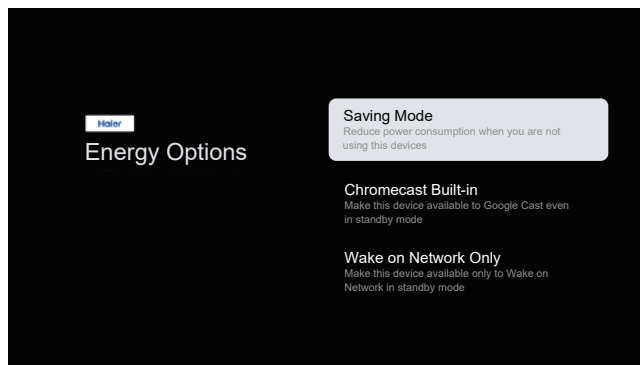

Selectați opțiunea "Saving Mode (Salvare mod)" și înaintați la următorul pas.

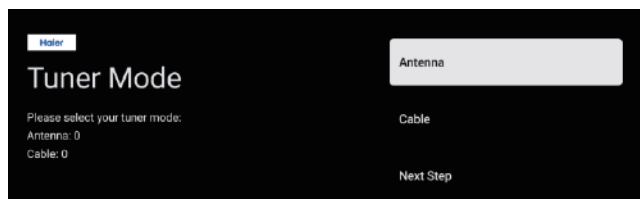

Selectați modul Tuner (Tuner) pentru căutare, apăsați pentru a selecta și apăsați tasta OK pentru a confirma.

INSTRUCȚIUNI DE UTILIZARE

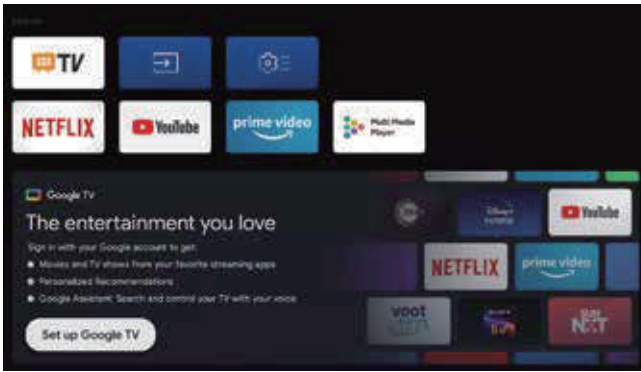

- Odată ce ați ajuns în interfața utilizatorului, puteți comuta de la opțiunea de bază la setările Google TV.

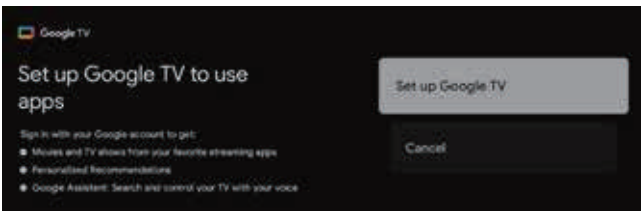

Apăsați tasta ▲/▼ pentru a selecta opțiunea "Set up Google TV (Stabilire Google TV)" pe dispozitivul dvs, și apăsați tasta OK pentru a finaliza configurarea.

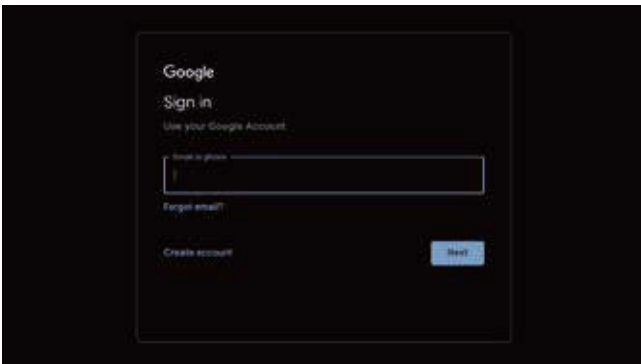

Utilizați opțiunea de autentificare a contului Google

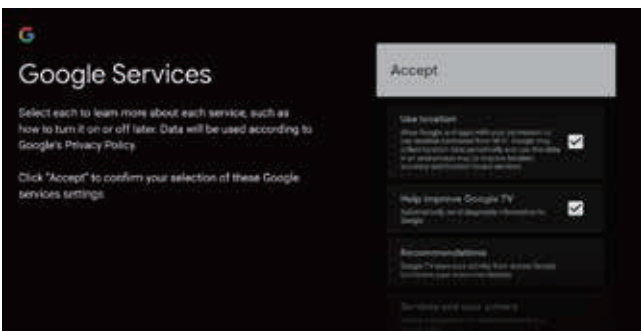
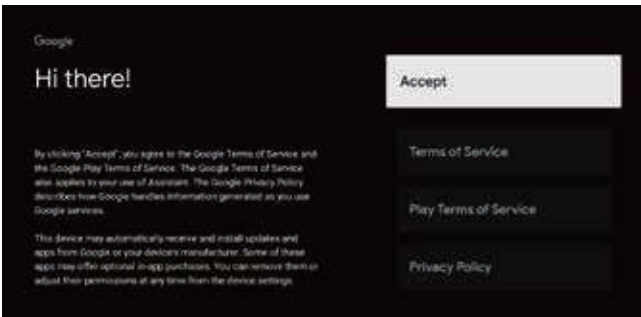

Acceptând Termenii de serviciu ai Google pentru a îmbunătăți experiența produsului, selectați opțiunea "Accept (Acceptă)" pentru a accepta această condiție.

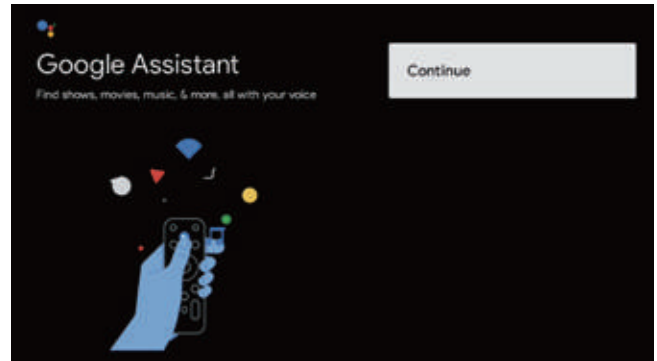

Apăsați pentru a selecta și apăsați tasta OK pentru a continua.

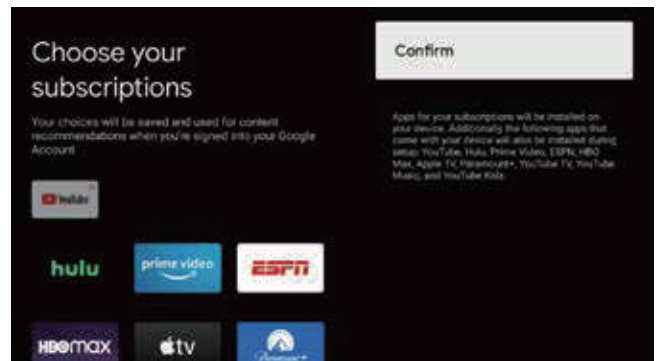

Apăsați tasta ▲/▼ pentru a selecta opțiunea Alegeți abonamentele dvs și apăsați tasta OK.

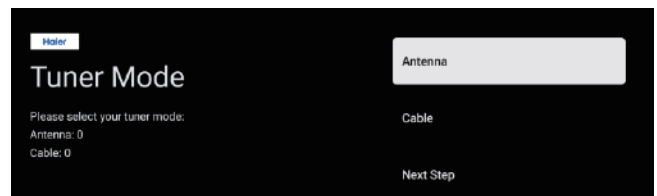

INSTRUCȚIUNI DE UTILIZARE

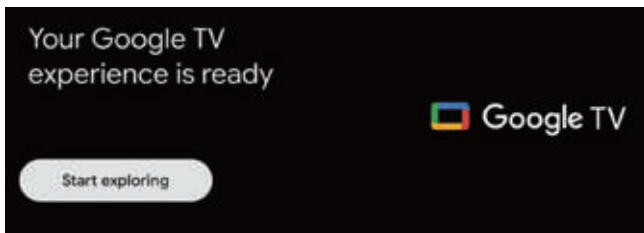

Experiența dvs. Google TV este pregătită și apăsați tasta OK pentru a începe explorarea.

ECRAN DE PORNIRE

După finalizarea Setărilor expertului. dvs. puteți urmări televizorul și puteți merge la ecranul de pornire.

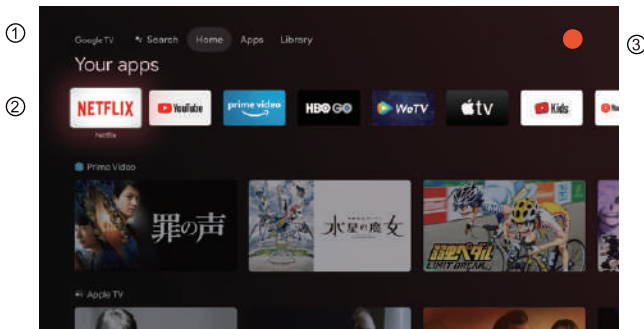

- ① **Search** Deschideți asistentul google sau porniți pentru o căutare vocală.
Home Deschide pagina de început a televizorului.
Apps Deschideți lista de aplicații instalate și adăugați aplicațiile dvs. favorite
Library Vizualizați conținutul achiziționat și închiriat de contul utilizatorului.
- ② O listă de aplicații pe care le-ați instalat și conținut al programelor instalate.
- ③ Deschideți informațiile contului, setările, ora, intrările și imaginea.
Settings (Setări): Unele setări pot fi configurate aici. Pentru detaliile despre setări, vezi următoarea explicație.
Inputs (Intrări): Pictogramă pentru a selecta o sursă de intrare.
Picture (Imagine): Utilizator poate seta fotografia televizorului. Consultați pagina 12 pentru instrucțiuni detaliate cu privire la configurare.

NAVIGAREA MENIULUI PE ECRAN

Există două modalități de a intra.. Prima, în opțiunea live TV, apăsați butonul meniu pentru a afișa opțiunile televizorului, apăsați tastele ▲/▼/◀/▶ pentru a selecta meniul setări și apăsați tasta OK pentru a confirma. A doua modalitate, în interfața HOME (ACASĂ), apăsați tasta ► pentru a selecta pictograma meniului ⚙️, apăsați tasta OK pentru a confirma.

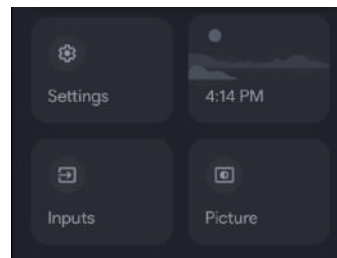
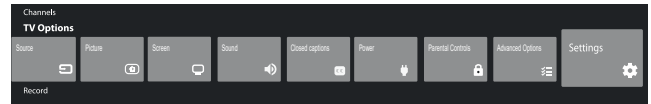

Apăsați tasta ▲/▼ pentru a selecta ceea ce doriți să setați. Apăsați tasta OK pentru a intra.

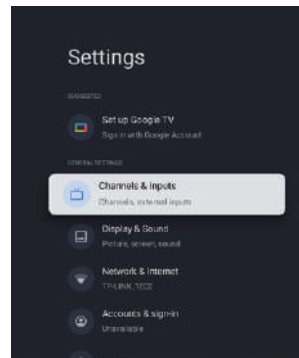

Apăsați tasta ÎNAPOI pentru a reveni la meniul principal.

Dacă meniul principal este afișat, apăsând tasta ÎNAPOI va închide meniul de pe ecran.

INSTRUCȚIUNI DE UTILIZARE

CANALE

Menu->Settings->Channels & Inputs->Channels
(Meniu->Setări->Canale & Intrări->Canale).

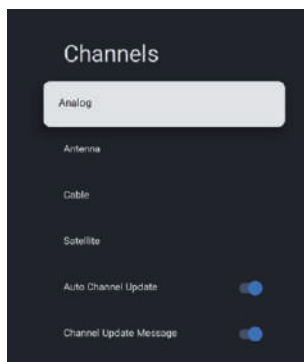

Analog/Antenna/Cable/Satellite (Analog/Antena/Cablu/Satelit) - Apăsați butonul ▲/▼ pentru a selecta opțiunea, apoi apăsați butonul OK pentru a intra în meniul secundar.

Auto Channel Update (Actualizare automată canal) - Apăsați butonul OK pentru a selecta **ON/OFF (ACTIVAT/DEZACTIVAT)**. Când selectați ACTIVAT, sistemul va scana și actualiza automat canalele după 5 minute de așteptare.

Channel Update Message (Mesaj actualizare canal - Apăsați) butonul OK pentru a selecta **ON/OFF (ACTIVAT/DEZACTIVAT)**. Când selectați ACTIVAT, sistemul vă va afișa mesajul de actualizare.

Notă: Sursa disponibilă poate fi diferită în funcție de model.

INTRĂRI

Menu->Settings->Channels & Inputs->Inputs
(Meniu->Setări->Canale & Intrări >Intrări).

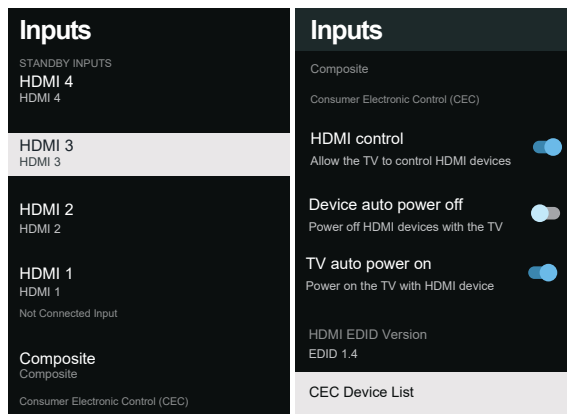

Inputs (Intrări) – Apăsați tasta ▲/▼ pentru a selecta opțiunea și apoi apăsați butonul OK pentru a intra în sub-meniu.

HDMI control (Control HDMI) – Apăsați tasta ▲/▼ pentru a selecta opțiunea și apoi apăsați butonul OK pentru a alege opțiunea PORNIT/OPRIT.

Device auto power off (Oprire automată a dispozitivului) – Apăsați tasta ▲/▼ pentru a selecta opțiunea, și apoi apăsați butonul OK pentru a alege opțiunea PORNIT/OPRIT.

TV auto power on (Pornire automată televizor) – Apăsați tasta ▲/▼ pentru a selecta opțiunea și apoi apăsați tasta OK pentru a alege opțiunea PORNIT/OPRIT.

HDMI EDID Version (Versiune EDID HDMI) – prezintă versiunea EDID.

CEC Device List (Listă dispozitiv CEC) – Apăsați tasta ▲/▼ pentru a selecta opțiunea și apoi apăsați tasta OK pentru a intra în sub-meniu.

AFIȘAJ ȘI SUNET

Menu->Settings-> Display & Sound (Meniu->Setări-> Afișaj și sunet).

În acest meniu, dvs. puteți stabili imaginea, și ieșirea audio a televizorului.

1. Apăsați tasta ▲/▼ pentru a selecta ceea ce doriți să setați.
2. Apăsați butonul OK pentru
3. După finalizarea configurării, apăsați butonul **ÎNAPOI** pentru a reveni la meniul anterior.

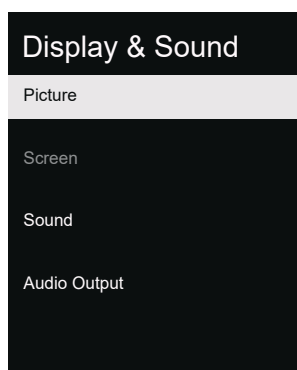

INSTRUCȚIUNI DE UTILIZARE

IMAGINE

Menu->Settings->Display & Sound-> Picture (Meniu->Setări->Afișaj și sunet-> Imagine).

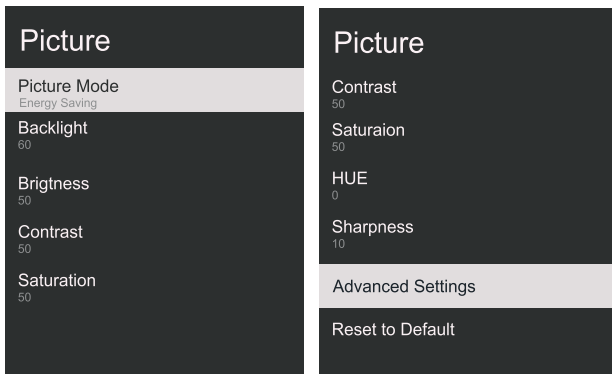

Picture Mode (Mod imagine) –

Apăsați tasta ▲/▼ pentru a selecta opțiunea și apoi apăsați butonul OK pentru a intra în sub-meniu.

(Opțional: utilizator, Standard, Vivid, Sport, Film, Joc, Economisire energie).

Backlight/Brightness/Contrast/Saturation/HUE/Sharpness (Iluminare din spate/Luminozitate/Contrast/Saturație/NUANȚĂ/Claritate) – Apăsați tasta ▲/▼ pentru a selecta opțiunea și apoi apăsați butonul OK pentru a intra.

Apăsați ◀ pentru a scădea parametrul. Apăsați ▶ pentru a mări parametrul.

Advanced Settings (Setări avansate) – Apăsați tasta ▲/▼ pentru a selecta opțiunea și apoi apăsați butonul OK pentru a intra în sub-meniu.

Reset to Default (Resetați la setările prestabilite) – Resetați toate setările la setările prestabilite din fabrică

SUNET

Menu->Settings-> Display & Sound->Sound (Meniu->Setări-> Afișaj și sunet->Sunet).

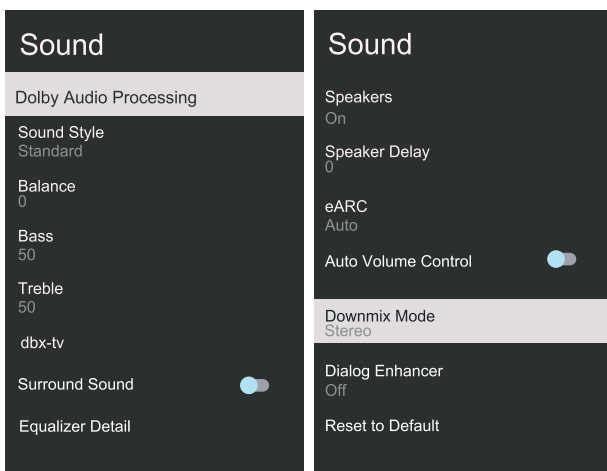

Dolby Audio processing (Procesare audio dolby) – Apăsați tasta ▲/▼ pentru a selecta opțiunea și apoi apăsați butonul OK pentru a intra în sub-meniu.

Sound style (Stil sunet) – Apăsați tasta ▲/▼ pentru a selecta opțiunea și apoi apăsați butonul OK pentru a intra în sub-meniu.

(Opțional: utilizator, Standard, Noapte, Sporturi, Film,

Muzică, Știri).

Balance/Bass/Tremble (Balans/ Bass/ Treble) – Apăsați tasta ▲/▼ pentru a selecta opțiunea și apoi apăsați butonul OK pentru a intra.

Apăsați ◀ pentru a scădea parametrul.

Apăsați ▶ pentru a mări parametrul.

dbx-tv (dbx- tv) – Apăsați tasta ▲/▼ pentru a selecta opțiunea și apoi apăsați butonul OK pentru a intra în sub-meniu.

Surround Sound (Sunet surround) – Apăsați tasta ▲/▼ pentru a selecta opțiunea și apoi apăsați butonul OK pentru a alege opțiunea PORNIT/OPRIT.

Equalizer Detail (Detalii egalizator) – Apăsați tasta ▲/▼ pentru a selecta opțiunea și apoi apăsați butonul OK pentru a intra în sub-meniu.

Speakers (Boxe) – Apăsați tasta ▲/▼ pentru a selecta opțiunea și apoi apăsați butonul OK pentru a alege opțiunea PORNIT/OPRIT.

Speaker Delay (Întârziere boxe) – Apăsați tasta ▲/▼ pentru a selecta opțiunea și apoi apăsați butonul OK pentru a intra.

Apăsați ◀ pentru a scădea parametrul. Apăsați ▶ pentru a mări parametrul.

eARC (eARC) – Apăsați tasta ▲/▼ pentru a selecta opțiunea, apoi apăsați tasta OK pentru a alege opțiunea Auto/OPRIT.

Auto Volume Control (Control automat volum) – Apăsați tasta ▲/▼ pentru a selecta opțiunea și apoi apăsați butonul OK pentru a alege opțiunea PORNIT/OPRIT

Downmix Mode (Mod downmix) – Apăsați tasta ▲/▼ pentru a selecta opțiunea și apoi apăsați butonul OK pentru a intra în sub-meniu.

(Opțional: Stereo, Surround).

Dialog Enhancer (Îmbunătățire dialog) – Apăsați tasta ▲/▼ pentru a selecta opțiunea, apoi apăsați butonul OK pentru a intra în sub-meniu.

(Opțional: Oprit, Scăzut, Mediu și Ridicat).

Reset to Default (Resetați la setările prestabilite) – Resetați toate setările la setările prestabilite din fabrică

IEȘIRE AUDIO

Menu->Settings->Display & Sound-> Audio Output (Meniu->Setări->Afișaj și sunet-> Ieșire audio).

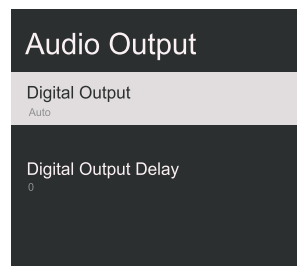

Digital Output (Ieșire digitală) – Apăsați tasta ▲/▼ pentru a selecta opțiunea apoi apăsați butonul OK pentru a intra în sub-meniu. (Opțional: Auto, Bypass, PCM, Dolby Digital Plus și Dolby Audio-Dolby Digital).

INSTRUCȚIUNI DE UTILIZARE

Digital Output Delay (Întârziere ieșire digitală) – Apăsați tasta ▲/▼ pentru a selecta opțiunea și apoi apăsați butonul OK pentru a intra. Apăsați ◀ pentru a scădea parametrul. Apăsați ▶ pentru a mări parametrul.

REȚEA

Menu->Settings->Network & Internet (Meniu->Setări->Rețea și internet).

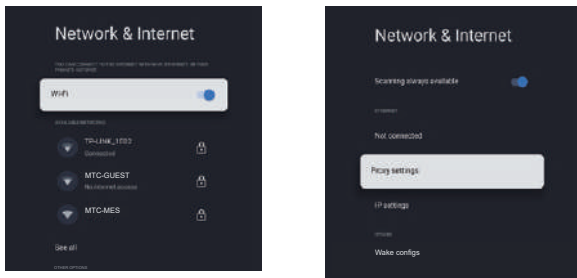

1. Apăsați tasta ▲/▼ pentru a selecta ceea ce doriți să setați.
2. Apăsați butonul OK pentru confirmare.
3. După finalizarea reglării, apăsați butonul OK pentru a salva și a reveni la meniul anterior.

CONTURI ȘI CONECTARE

1. Menu->Settings->Accounts & sign-in (Meniu->Setări->Conturi și conectare).
2. În interfața HOME (ACASĂ), apăsați tastele ▲/▼ pentru a selecta opțiunea "Set up Google TV (Stabilire TV Google)" și continuați cu următorul pas.

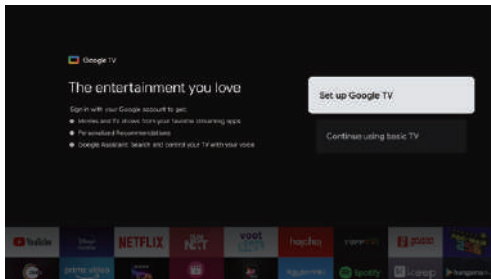

Selectați opțiunea "Set up Google TV (Stabilire TV Google)" și continuați cu următorul pas, introduceți contul și parola.

Și urmăriți mesajele pentru a finaliza setările relevante.

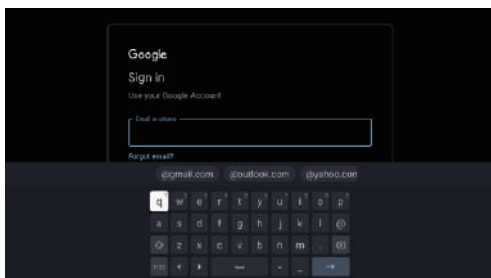

CONFIDENȚIALITATE

Menu->Settings->Privacy (Meniu->Setări->Confidențialitate).

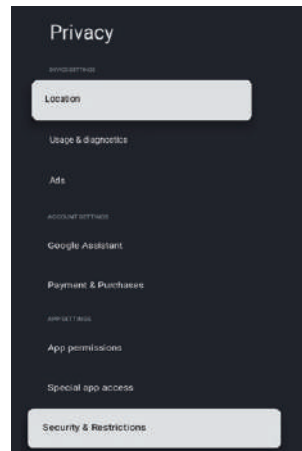

În acest meniu, dvs. vă puteți seta locația, utilizare și diagnosticare etc. al televizorului.

1. Apăsați tasta ▲/▼ pentru a selecta ceea ce doriți să setați.
2. Apăsați butonul OK pentru confirmare.
3. După finalizarea configurării, apăsați butonul ÎNAPOI pentru a reveni la meniul anterior.

LOCAȚIE

Menu->Settings->Privacy ->Location (Meniu->Setări->Confidențialitate ->Locație).

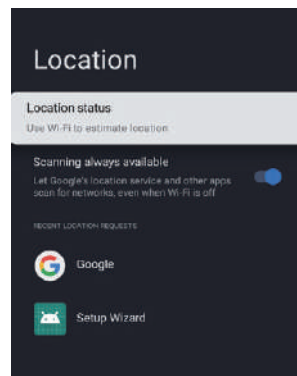

Location status (Stare locație) – Apăsați tasta ▲/▼ pentru a selecta opțiunea și apoi apăsați tasta OK pentru a intra în sub-meniu (Opțional: Utilizați Wi-Fi pentru a estima locația, Oprit)

Scanning always available (Scanarea întotdeauna disponibilă) – Apăsați tastele ▲/▼ pentru a selecta opțiunea și apoi apăsați tasta OK pentru a alege opțiunea PORNIT/OPRIT.

UTILIZARE ȘI DIAGNOSTICARE

Menu->Settings->Privacy ->Usage & diagnostics (Meniu->Setări->Confidențialitate ->Utilizare și diagnosticare).

INSTRUCȚIUNI DE UTILIZARE

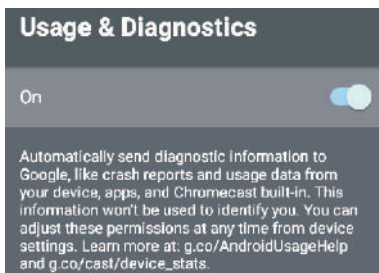

Usage & diagnostics (Utilizare și diagnosticare) – Apăsați taste ▲/▼ pentru a selecta opțiunea și apoi apăsați tasta OK pentru a alege opțiunea PORNIT/OPRIT.

APLICAȚII

Menu->Settings->Apps (Menu->Setări->Aplicații).

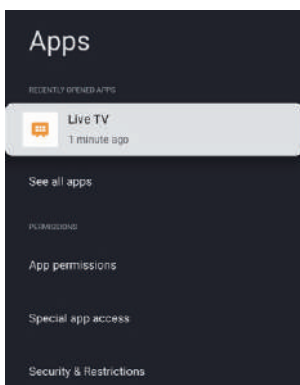

În acest meniu, dvs. vă puteți permisiunile APLICAȚIILOR, și să citiți listele de aplicații.

1. Apăsați tasta ▲/▼ pentru a selecta ceea ce doriți să setați.
2. Apăsați butonul OK pentru confirmare.
3. După finalizarea configurării, apăsați butonul ÎNAPOI pentru a reveni la meniul anterior.

SISTEM

Menu->Settings->System (Menu->Setări->Sistem).

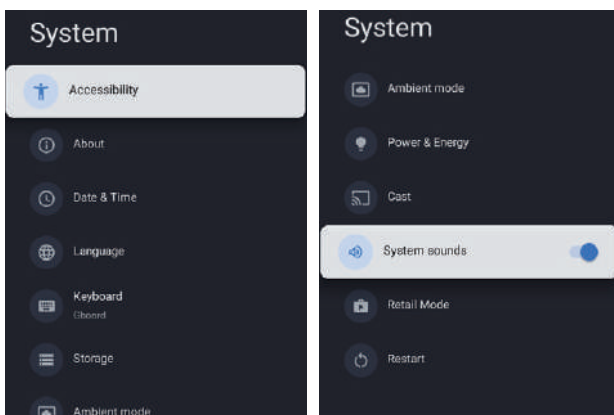

În acest meniu, dvs. puteți citi informațiile și setările televizorului.

1. Apăsați tasta ▲/▼ pentru a selecta ceea ce doriți să setați.
2. Apăsați butonul OK pentru confirmare.
3. După finalizarea configurării, apăsați butonul ÎNAPOI pentru a reveni la meniul anterior.

System sounds (Audio sistem) – Apăsați butonul ▲/▼ pentru a selecta opțiunea și apoi apăsați butonul OK pentru a alege opțiunea PORNIT/OPRIT. Pentru detalii despre sistem, consultați următoarea explicație.

ACCESIBILITATE

Menu->Settings->System -> Accessibility (Menu->Setări->Sistem -> Accesibilitate).

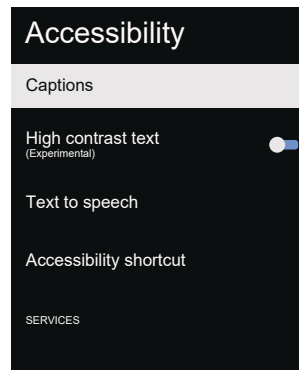

Captions (Capturi) – Apăsați butonul ▲/▼ pentru a selecta opțiunea, și apoi apăsați butonul OK pentru a intra în sub-meniu.

High contrast text (Text cu contrast ridicat) –

Apăsați butonul ▲/▼ pentru a selecta opțiunea și apoi apăsați butonul OK pentru a alege opțiunea PORNIT/OPRIT.

Text to speech (Text către vorbire) – Apăsați butonul ▲/▼ pentru a selecta opțiunea și apoi apăsați butonul OK pentru a intra în sub-meniu.

Accessibility shortcut (Scurtătură accesibilitate) – Apăsați butonul ▲/▼ pentru a selecta opțiunea și apoi apăsați butonul OK pentru a intra în sub-meniu.

DESPRE

Menu->Settings->System ->About (Menu->Setări->Sistem ->Despre).

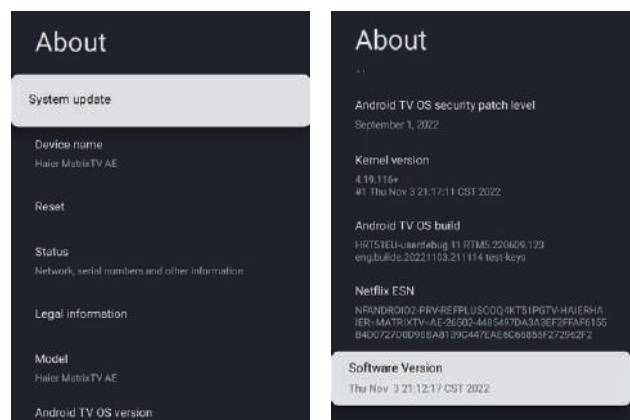

În acest meniu, dvs. puteți actualiza sistemul, reseta și citi informații despre televizor.

1. Apăsați tasta ▲/▼ pentru a selecta ceea ce doriți să setați.
2. Apăsați butonul OK pentru confirmare.
3. După finalizarea configurării, apăsați butonul ÎNAPOI pentru a reveni la meniul anterior.

INSTRUCȚIUNI DE UTILIZARE

DATA ȘI ORA

Menu->Settings->System -> Date & Time (Meniu->Setări->Sistem -> Data și ora).

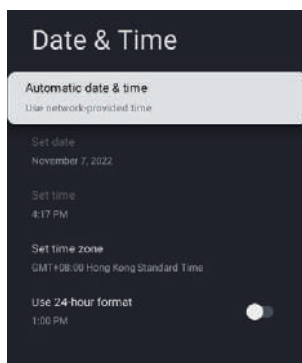

Automatic date & time (Dată și oră automată) – Apăsați butonul ▲/▼ pentru a selecta opțiunea și apoi apăsați butonul OK pentru a intra în sub-meniu. (Opțional: Utilizați ora furnizată de rețea. Oprit)

NOTĂ

- Când data și ora automate sunt dezactivate, puteți utiliza Ajustarea manuală a datei și orei.

Set date (Setați data) – Apăsați butonul ▲/▼ pentru a selecta opțiunea și apoi apăsați butonul OK pentru a intra în sub-meniu.

Set time (Setați ora) – Apăsați butonul ▲/▼ pentru a selecta opțiunea și apoi apăsați butonul OK pentru a intra în sub-meniu.

Set time zone (Setați fusul orar) – Apăsați butonul ▲/▼ pentru a selecta opțiunea și apoi apăsați butonul OK pentru a intra în sub-meniu.

Use 24-hour format (Utilizați format de 24 ore) – Apăsați butonul ▲/▼ pentru a selecta opțiunea și apoi apăsați butonul OK pentru a alege opțiunea PORNIT/OPRIT.

LIMBĂ

Menu->Settings->System-> Language (Meniu->Setări->Sistem-> Limbă).

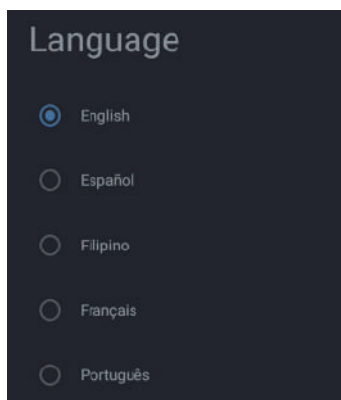

Language (Limbă) – Apăsați butonul ▲/▼ pentru a selecta opțiunea și apoi apăsați butonul OK pentru a selecta limba.

TASTATURĂ

Menu->Settings->System-> Keyboard (Meniu->Setări->Sistem-> Tastatură).

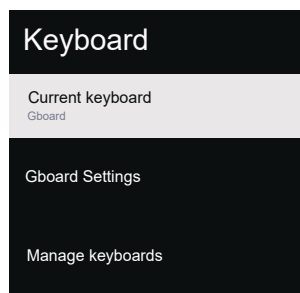

Current keyboard (Tastatură curentă) – Apăsați tasta ▲/▼ pentru a selecta opțiunea și apoi apăsați butonul OK pentru a intra în sub-meniu.

Gboard Settings (Setări Gboard) – Apăsați tasta ▲/▼ pentru a selecta opțiunea și apoi apăsați butonul OK pentru a intra în sub-meniu.

Manage keyboards (Administrează tastaturi) – Apăsați tasta ▲/▼ pentru a selecta opțiunea și apoi apăsați butonul OK pentru a intra în sub-meniu.

STOCARE

Menu->Settings-> System->Storage (Meniu->Setări-> Sistem->Stocare).

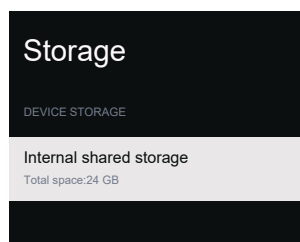

Internal shared storage (Stocare internă partajată) – Apăsați tasta ▲/▼ pentru a selecta opțiunea și apoi apăsați butonul OK pentru a intra în sub-meniu.

MOD AMBIENT

Menu->Settings->System-> Ambient mode (Meniu->Setări->Sistem-> Mod ambient).

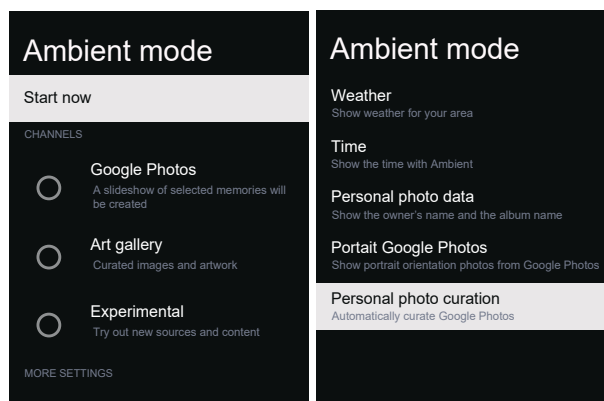

În acest meniu, dvs. puteți seta modul ambient.

1. Apăsați butonul ▲/▼ pentru a selecta ceea ce doriți să seletăți.
2. Apăsați butonul OK pentru confirmare.
3. După finalizarea configurării, apăsați butonul ÎNAPOI pentru a reveni la meniul anterior.

INSTRUCȚIUNI DE UTILIZARE

ALIMENTARE & ENERGIE

Menu->Settings-> System->Power & Energy (Meniu->Setări-> Sistem->Alimentare & energie).

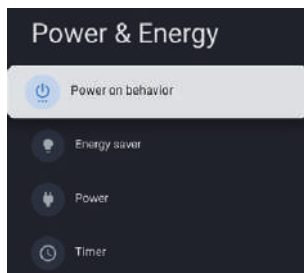

În acest meniu, dvs. puteți seta alimentarea și energia.

(alimentare pe comportament, economisire energie și cronometru)

1. Apăsați tasta ▲/▼ pentru a selecta ceea ce doriți să setați.
2. Apăsați butonul OK pentru confirmare.
3. După finalizarea configurării, apăsați butonul ÎNAPOI pentru a reveni la meniul anterior.

ALIMENTARE PE COMPORTAMENT

Menu->Settings->System->Power & Energy->Power on behavior (Meniu->Setări->Sistem->Alimentare și energie->Alimentare pe comportament).

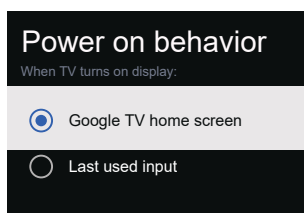

Apăsați tasta ▲/▼ pentru a selecta opțiunea și apoi apăsați tasta OK pentru a confirma.

ECONOMISIRE ENERGIE

Menu->Settings->System-> Power & Energy ->Energy saver (Meniu->Setări->Sistem-> Alimentare & energie ->Economisire energie).

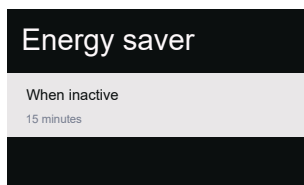

When inactive (Atunci când este inactiv) – Apăsați tasta ▲/▼ pentru a selecta opțiunea și apoi apăsați tasta OK pentru a intra în sub-meniu.

(Opțional: 15 minute, 20 minute, 30 minute, o oră, 4 ore, 8 ore, 12 ore, 24 ore, Niciodată).

ALIMENTARE

Menu->Settings->System-> Power & Energy->Power (Meniu->Setări->Sistem-> Alimentare & energie->Alimentare).

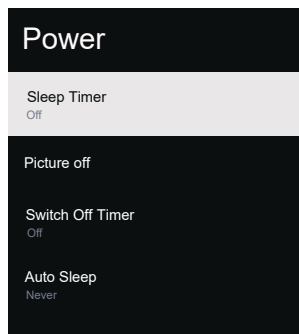

Sleep Timer (Cronometru somn) – Apăsați tasta ▲/▼ pentru a selecta opțiunea și apoi apăsați tasta OK pentru a intra în sub-meniu.

(Opțional: oprit, 10 minute, 20 minute, 30 minute, 40 minute, 50 minute, 60 minute, 90 minute, 120 minute)

Picture off (Imagine oprită) – Apăsați tasta ▲/▼ pentru a selecta opțiunea și apoi apăsați tasta OK pentru a confirma.

Switch off timer (Oprire cronometru) – Apăsați tasta ▲/▼ pentru a selecta opțiunea și apoi apăsați tasta OK pentru a intra în sub-meniu.

(Opțional: oprit, 30 minute, 60 minute, 90 minute, 120 minute, 150 minute, 180 minute, 210 minute, 240 minute)

Auto Sleep (Adormire automată) – Apăsați tasta ▲/▼ pentru a selecta opțiunea și apoi apăsați butonul OK pentru a intra în sub-meniu (Opțional: Niciodată, 4 ore, 6 ore, 8 ore)

CRONOMETRU

Menu->Settings-> System-> Power & Energy->Timer (Meniu->Setări-> Sistem-> Alimentare și energie->Cronometru).

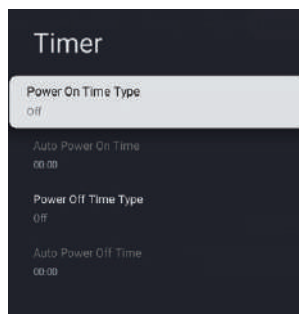

Power On Time Type (Alimentare tip timp) – Apăsați tasta ▲/▼ pentru a selecta opțiunea și apoi apăsați butonul OK pentru a alege opțiunea OPRIT/PORNIT/ODATĂ.

Auto Power On Time (Alimentare automată la timp) – Apăsați tasta ▲/▼ pentru a selecta opțiunea și apoi apăsați butonul OK pentru a intra în sub-meniu.

Power Off Time Type (Oprire alimentare tip timp) – Apăsați tasta ▲/▼ pentru a selecta opțiunea și apoi apăsați butonul OK pentru a alege opțiunea OPRIT/PORNIT/ODATĂ.

Auto Power Off Time (Oprire alimentată automată la timp) – Apăsați tasta ▲/▼ pentru a selecta opțiunea și apoi apăsați butonul OK pentru a intra în sub-meniu.

INSTRUCȚIUNI DE UTILIZARE

DISTRIBUIRE

Menu->Settings->System-> Cast (Meniu->Setări->Sistem-> Distribuire).

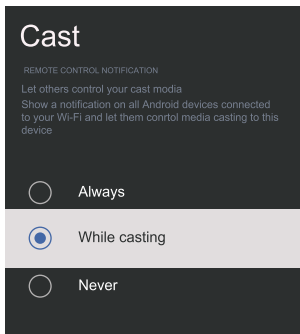

1. Apăsați tasta ▲/▼ pentru a selecta ceea ce doriți să setați.
2. Apăsați butonul OK pentru confirmare.
3. Apăsați tasta ÎNAPOI pentru a reveni la meniul anterior.

MOD DISTRIBUȚIE

Menu->Settings->System-> Retail Mode (Meniu->Setări->Sistem-> Mod de distribuție).

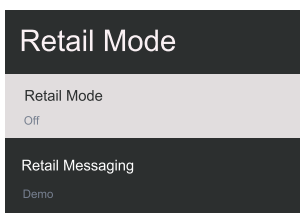

- Retail mode (Mod de distribuție)** – Apăsați tasta ▲/▼ pentru a selecta opțiunea și apoi apăsați butonul OK pentru a alege opțiunea PORNIT/OPRIT.
- Retails messaging (Mesagerie de distribuție)** – Apăsați tasta ▲/▼ pentru a selecta opțiunea și apoi apăsați butonul OK pentru a intra în sub-meniu. (Notă: Demo, e-POP, e-POP +Demo)

REPORNIRE

Menu->Settings->System-> Restart (Meniu->Setări->Sistem-> Repornire).
Apăsați butonul OK pentru a intra în sub-meniu. (Opțional: repornire și anulare)

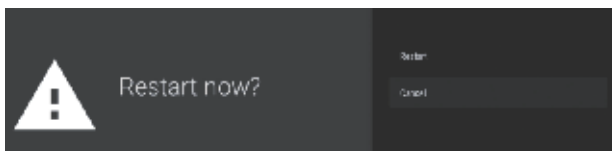

TELECOMENZI ȘI ACCESORII

Menu->Settings-> Remotes & Accessories (Meniu->Setări-> Telecomenzi și accesorii).

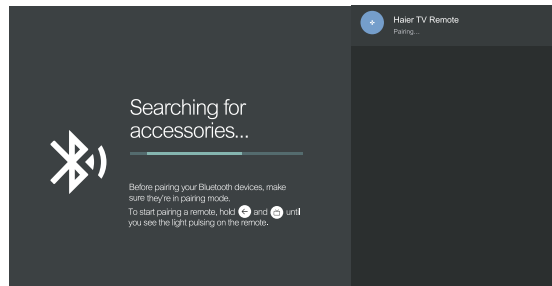
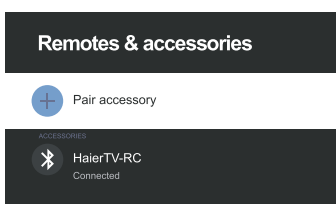

În acest meniu, dvs. puteți asocia dispozitivele Bluetooth.

1. Apăsați butoanele "←" și "☐" din partea inferioară a telecomenzii timp de 5 secunde.
2. În momentul când LED începe să clipească, eliberați butoanele. Telecomanda va trimite un semnal de asociere către televizor și afișează informațiile telecomenzii pe partea dreaptă a ecranului.
3. Apăsați butonul OK pentru a afișa asocierea. Dacă asocierea este afișată, conexiunea este de succes.
4. Dacă asocierea nu este afișată, conexiunea nu este de succes. Așteptați 30 secunde și apoi apăsați butoanele "←" și "☐" aflat în partea inferioară a telecomenzii timp de 5 secunde pentru a repeta pașii anteriori.
5. Apăsați butonul ← pentru a reveni la meniul anterior.

UTILIZAREA PLAYER-ULUI MULTIMEDIA

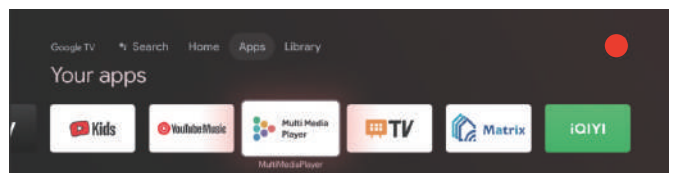

1. În interfața ACASĂ sau APLICAȚII, apăsați tasta ▲/▼/◀/▶ pentru a selecta aplicația Multi Media Player

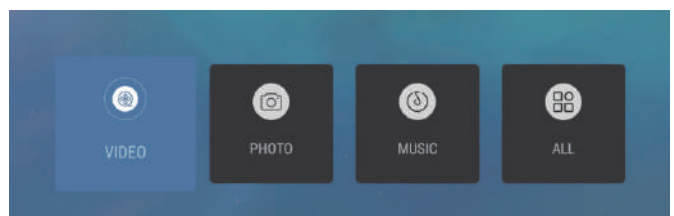

2. Selectați tasta OK pentru a intra în Multi Media Player și afișați Video, Foto, Audio. După introducerea dispozitivului usb, dvs. puteți vizualiza fișierele corespunzătoare din dispozitivul usb (Format FAT32).

NOTĂ

Meniul poate diferi depinzând de momentul când ați achiziționat televizorul.

DEPANARE

Vă rugăm să efectuați acești pași simpli înainte de a apela la service. Aceste sfaturi vă pot economisi timp și bani deoarece taxele pentru montajul receiver-ului și reglarea comenzilor nu este acoperită de garanția dvs.

Simptome	Articole pentru verificare și acțiuni pentru a le urma
"Fantomă" sau imagine dublă	<ul style="list-style-type: none">Aceasta poate fi cauzată de obstrucționarea antenei datorită unor clădiri înalte sau dealuri. Utilizarea unei antenă direcționale poate îmbunătăți imaginea.
Fără alimentare	<ul style="list-style-type: none">Verificați dacă cablul de alimentare al televizorului este conectat la priză.Deconectați televizorul, așteptați timp de 60 de secunde. Apoi reintroduceți ștecherul în priză și porniți din nou televizorul.
Nicio imagine	<ul style="list-style-type: none">Verificați conexiunea antenei aflată în partea din spate a televizorului pentru a verifica dacă este conectată corespunzător.Posibil defecțiune a stației de televiziune. Încercați un alt canal.Reglați setările cu privire la contrast și luminozitate.Verificați controlul capturilor. Unele moduri TEXT poate bloca ecranul.
Imagine bună dar fără sunet	<ul style="list-style-type: none">Apăsăți butonul MUTE de pe telecomandă pentru a se asigura că opțiunea este oprită.
Sunet bun dar fără culoare	<ul style="list-style-type: none">Reglați setările de contrast, culoare și luminozitate.
Imagine slabă	<ul style="list-style-type: none">Calitatea slabă a imaginii poate apărea în momentul când o cameră S-VHS sau camcorderul este conectat la televizorul dvs. și alte periferice în acel timp. Opriți una din periferice.
Imagine în ceață și zgomot	<ul style="list-style-type: none">Verificați conexiunea antenei
Line orizontală punctată	<ul style="list-style-type: none">Acest lucru poate fi cauzat de către interferențe electrice (de ex. uscător de păr, lumini neon, etc.) Opriți echipamentul.
Televizorul nu răspunde la telecomandă	<ul style="list-style-type: none">Verificați dacă bateriile funcționează. Înlocuiți dacă este necesar.Curățați lentilele senzorului de pe telecomandă.
Pixeli (puncte) care sunt întotdeauna întunecați sau întotdeauna aprinși.	<ul style="list-style-type: none">Televizorul dvs. este un echipament fabricat cu precizie ce utilizează un nivel ridicat de tehnologie. Totuși, unii pixeli nu vor fi afișați corect. Aceste tipuri de apariții sunt asociate cu acest tip de produs și nu constituie un produs defect.

NOTĂ

- Acest produs utilizează un panou ce este constituit din sub-pixeli care necesită o tehnologie sofisticată pentru a îl produce. Totuși, pot exista câțiva pixeli deschiși sau închiși pe ecran. Acești pixeli nu au impact asupra performanței produsului.



Termenii HDMI, HDMI High-Definition Multimedia Interface, HDMI Trade dress și logo-ul HDMI sunt mărci comerciale sau mărci comerciale înregistrate ale HDMI Licensing Administrator, Inc.



Dolby, Dolby Vision, Dolby Atmos, Dolby Audio și simbolul dublu-D sunt mărci comerciale ale Dolby Laboratories Licensing Corporation. Produs sub licență Dolby Laboratories. Lucrări confidențiale nepublicate. Drepturi de autor ©2012-2024 Dolby Laboratories. Toate drepturile rezervate.

SPECIFICAȚIILE PRODUSULUI

Televizor LED UHD de 43"

Calitatea imaginii televizorului:	UHD Digital integrat. Dimensiune ecran 108 cm Rezoluție 3840x2160 pixeli 60Hz.
Sistem televizor;	PAL-B/G, SECAM-B/G
Decoder DTV Tuner	DVB-T, DVB-C, DVB-T2, DVB-S2 16/32/64/128/256 modulare QAM MPEG2, MPEG4, H.265
Conectivitate:	1 port optic 2 porturi USB 1 LAN 4 orificii HDMI 1 orificiu VIDEO 1 orificiu în partea stângă 1 orificiu în partea dreaptă 2 orificii în partea dreaptă 1 port pentru CĂȘTI 1 slot CI Sisteme suportate: PAL+SECAM Depozitare număr canal: 1000(DTV), 100(ATV) TV (RF): 75Ω Dezechilibru Intrare video AV: 75 Ω, 1V-P, RCA Intrare audio AV: 20KΩ, 500mV RMS Intrare video HDMI: 480i, 480p, 720p, 1080i, 1080p, 2160p WiFi: Standard: IEEE 802.11 a/b/g/n/ac, Frecvență: 2.4GHz/5GHz Bluetooth: V5.1
Calitate audio:	Sistem audio stereo 2 x 10 watts energie produsă RMS.
Consum de energie în așteptare	≤0.5W
Caracteristici digitale:	Interactiv digital Text digital. Subtitrări transmitere digitală video sunt (DVB) sunt disponibile. Configurare automată Scanare automată pentru noile canale Ghid de program acum și următor Ghid electronic de programe pe 7 zile (EPG) Slot CI Descriere audio compatibil
Caracteristici suplimentare:	Tuner UHF/VHF; cronometru dormire; Îndrumare parentală, Imagine și text Bateriile telecomenzii sunt necesare 2 x AAA. Dimensiune de montaj VESA: 300x300mm Dimensiune ambalaj (WxHxD): 1075x652x142mm Dimensiune set (WxHxD) cu stand: 957.2x607.4x240.7mm Dimensiune set (WxHxD) fără stand: 957.2x566.7x86.6mm Greutate pachet: 10 kg Greutate set cu stand: 7.2 kg Greutate set fără stand 6.8 kg

* Specificațiile componentelor acestui televizor care sunt furnizate aici sunt doar pentru referință. Diferențele pot apărea deoarece tehnologia produsului este actualizată. Modelul și specificațiile pot fi modificate fără preaviz.

SPECIFICAȚIILE PRODUSULUI

Televizor LED UHD de 50"

Calitatea imaginii televizorului:	UHD Digital integrat. Dimensiune ecran 126cm Rezoluție 3840x2160 pixeli 60Hz.
Sistem televizor;	PAL-B/G, SECAM-B/G
Decoder DTV Tuner	DVB-T, DVB-C, DVB-T2, DVB-S2 16/32/64/128/256 modulare QAM MPEG2, MPEG4, H.265
Conectivitate:	1 port optic 2 porturi USB 1 LAN 4 orificii HDMI 1 orificiu VIDEO 1 orificiu în partea stângă 1 orificiu în partea dreaptă 2 orificii în partea dreaptă 1 port pentru CĂȘTI 1 slot CI Sisteme suportate: PAL+SECAM Depozitare număr canal: 1000(DTV), 100(ATV) TV (RF): 75 Ω Dezechilibru Intrare video AV: 75 Ω, 1V-P, RCA Intrare audio AV: 20KΩ, 500mV RMS Intrare video HDMI: 480i, 480p, 720p, 1080i, 1080p, 2160p WiFi: Standard: IEEE 802.11 a/b/g/n/ac, Frecvență: 2.4GHz/5GHz Bluetooth: V5.1
Calitate audio:	Sistem audio stereo 2 x 13.5 watts energie produsă RMS.
Consum de energie în așteptare	≤0.5W
Caracteristici digitale:	Interactiv digital Text digital. Subtitrări transmitere digitală video sunt (DVB) sunt disponibile. Configurare automată Scanare automată pentru noile canale Ghid de program acum și următor Ghid electronic de programe pe 7 zile (EPG) Slot CI Descriere audio compatibil
Caracteristici suplimentare:	Tuner UHF/VHF; cronometru dormire; Îndrumare parentală, Imagine și text Bateriile telecomenzii sunt necesare 2 x AAA. Dimensiune de montaj VESA: 300x300mm Dimensiune ambalaj (WxHxD): 1250x760x144mm Dimensiune set (WxHxD) cu stand: 1111.2x710.5x277.2mm Dimensiune set (WxHxD) fără stand: 1111.2x651.8x88mm Greutate pachet: 13.5kg Greutate set cu stand: 10 kg Greutate set fără stand 9.5kg

* Specificațiile componentelor acestui televizor care sunt furnizate aici sunt doar pentru referință. Diferențele pot apărea deoarece tehnologia produsului este actualizată. Modelul și specificațiile pot fi modificate fără preaviz.

SPECIFICAȚIILE PRODUSULUI

Televizor LED UHD de 55"

Calitatea imaginii televizorului:	UHD Digital integrat. Dimensiune ecran 139 cm Rezoluție 3840x2160 pixeli 60Hz.
Sistem televizor;	PAL-B/G, SECAM-B/G
Decoder DTV Tuner	DVB-T, DVB-C, DVB-T2, DVB-S2 16/32/64/128/256 modulare QAM MPEG2, MPEG4, H.265
Conectivitate:	1 port optic 2 porturi USB 1 LAN 4 orificii HDMI 1 orificiu VIDEO 1 orificiu în partea stângă 1 orificiu în partea dreaptă 2 orificii în partea dreaptă 1 port pentru CĂȘTI 1 slot CI Sisteme suportate: PAL+SECAM Depozitare număr canal: 1000(DTV), 100(ATV) TV (RF): 75Ω Dezechilibru Intrare video AV: 75 Ω, 1V-P, RCA Intrare audio AV: 20KΩ, 500mV RMS Intrare video HDMI: 480i, 480p, 720p, 1080i, 1080p, 2160p WiFi: Standard: IEEE 802.11 a/b/g/n/ac, Frecvență: 2.4GHz/5GHz Bluetooth: V5.1
Calitate audio:	Sistem audio stereo 2 x 13.5 watts energie produsă RMS.
Consum de energie în așteptare	≤0.5W
Caracteristici digitale:	Interactiv digital Text digital. Subtitrări transmitere digitală video sunt (DVB) sunt disponibile. Configurare automată Scanare automată pentru noile canale Ghid de program acum și următor Ghid electronic de programe pe 7 zile (EPG) Slot CI Descriere audio compatibil
Caracteristici suplimentare:	Tuner UHF/VHF; cronometru dormire; Îndrumare parentală, Imagine și text Bateriile telecomenzii sunt necesare 2 x AAA. Dimensiune de montaj VESA: 300x300mm Dimensiune ambalaj (WxHxD): 1350x837x144mm Dimensiune set (WxHxD) cu stand: 1225.8x777.3x277.2mm Dimensiune set (WxHxD) fără stand: 1225.8x719.4x88.1mm Greutate pachet: 16.4kg Greutate set cu stand: 11.9kg Greutate set fără stand 11.4kg

* Specificațiile componentelor acestui televizor care sunt furnizate aici sunt doar pentru referință. Diferențele pot apărea deoarece tehnologia produsului este actualizată. Modelul și specificațiile pot fi modificate fără preaviz.

SPECIFICAȚIILE PRODUSULUI

Televizor LED UHD de 65"

Calitatea imaginii televizorului:	UHD Digital integrat. Dimensiune ecran 164cm Rezoluție 3840x2160 pixeli 60Hz.
Sistem televizor;	PAL-B/G, SECAM-B/G
Decoder DTV Tuner	DVB-T, DVB-C, DVB-T2, DVB-S2 16/32/64/128/256 modulare QAM MPEG2, MPEG4, H.265
Conectivitate:	1 port optic 2 porturi USB 1 LAN 4 orificii HDMI 1 orificiu VIDEO 1 orificiu în partea stângă 1 orificiu în partea dreaptă 2 orificii în partea dreaptă 1 port pentru CĂȘTI 1 slot CI Sisteme suportate: PAL+SECAM Depozitare număr canal: 1000(DTV), 100(ATV) TV (RF): 75 Ω Dezechilibru Intrare video AV: 75 Ω, 1V-P, RCA Intrare audio AV: 20KΩ, 500mV RMS Intrare video HDMI: 480i, 480p, 720p, 1080i, 1080p, 2160p WiFi: Standard: IEEE 802.11 a/b/g/n/ac, Frecvență: 2.4GHz/5GHz Bluetooth: V5.1
Calitate audio:	Sistem audio stereo 2 x 13.5 watts energie produsă RMS.
Consum de energie în așteptare	≤0.5W
Caracteristici digitale:	Interactiv digital Text digital. Subtitrări transmitere digitală video sunt (DVB) sunt disponibile. Configurare automată Scanare automată pentru noile canale Ghid de program acum și următor Ghid electronic de programe pe 7 zile (EPG) Slot CI Descriere audio compatibil
Caracteristici suplimentare:	Tuner UHF/VHF; cronometru dormire; Îndrumare parentală, Imagine și text Bateriile telecomenzii sunt necesare 2 x AAA. Dimensiune de montaj VESA: 400x300mm Dimensiune ambalaj (WxHxD): 1600x960x164mm Dimensiune set (WxHxD) cu stand: 1446.4x904.7x313.8mm Dimensiune set (WxHxD) fără stand: 1446.4x841.3x85.1mm Greutate pachet: 24 kg Greutate set cu stand: 17.2 kg Greutate set fără stand 16.8kg

* Specificațiile componentelor acestui televizor care sunt furnizate aici sunt doar pentru referință. Diferențele pot apărea deoarece tehnologia produsului este actualizată. Modelul și specificațiile pot fi modificate fără preaviz.

Haier

Haier

Вдохновение для жизни

Руководство
пользователя

МОДЕЛИ:

H43Q80FUX

H50Q80FUX

H55Q80FUX

H65Q80FUX



Изображения в данном руководстве приводятся исключительно для справки и могут отличаться от фактического внешнего вида устройства. Конструкция и характеристики устройства могут быть изменены без предварительного уведомления.

LED-телевизор

СОДЕРЖАНИЕ

1. ВАЖНЫЕ ИНСТРУКЦИИ ПО ТЕХНИКЕ БЕЗОПАСНОСТИ	1
2. ПОДГОТОВКА К ИСПОЛЬЗОВАНИЮ	3
3. ПОДКЛЮЧЕНИЕ ПЕРИФЕРИЙНЫХ УСТРОЙСТВ И ОРГАНЫ УПРАВЛЕНИЯ	5
4. ПОДКЛЮЧЕНИЕ	6
5. ИНСТРУКЦИЯ ПО ЭКСПЛУАТАЦИИ	7
6. ПОИСК И УСТРАНЕНИЕ НЕИСПРАВНОСТЕЙ	20
7. ХАРАКТЕРИСТИКИ ПРОДУКТА.....	21



Изображения в данном руководстве приводятся исключительно для справки и могут отличаться от фактического внешнего вида устройства.
Конструкция и характеристики устройства могут быть изменены без предварительного уведомления.



ВАЖНЫЕ ИНСТРУКЦИИ ПО ТЕХНИКЕ БЕЗОПАСНОСТИ

- 1) Прочитайте настоящие инструкции.
- 2) Сохраните эти инструкции.
- 3) Не игнорируйте предупреждения.
- 4) Выполняйте все указания.
- 5) Не используйте данный прибор вблизи воды.
- 6) Очищать только сухой тканью.
- 7) Не закрывайте вентиляционные отверстия, соблюдайте инструкции по установке.
- 8) Не устанавливайте устройство рядом с источниками тепла, в том числе радиаторами отопления, обогревателями, печами и другими устройствами, которые излучают тепло (включая усилители звука).
- 9) Не нарушайте работу системы безопасности поляризованной вилки. Если вилка устройства не подходит для вашей розетки, обратитесь к электрику для ее замены.
- 10) Следите за тем, чтобы на провод питания никто не наступал и не пережимал его, особенно рядом с вилкой, электророзеткой и местом подключения устройству.
- 11) Используйте только аксессуары и принадлежности, рекомендованные производителем устройства.
- 12) Отключайте устройство во время грозы или если не планируете использовать его в течение длительного времени.
- 13) Любое сервисное обслуживание прибора должны выполнять только квалифицированные специалисты сервисной службы. При наличии любых повреждений, например повреждений провода питания или штепсельной вилки, в случае попадания внутрь устройства жидкостей или посторонних предметов, воздействия на него дождя или влаги, падения устройства или нарушения его нормальной работы необходимо провести техническую проверку.
- 14) Штепсельная вилка используется для отключения устройства, поэтому доступ к ней всегда должен быть свободен.
- 15) Вентиляция не должна нарушаться вследствие перекрытия вентиляционных отверстий такими предметами, как газеты, скатерти, занавески и т. д.
- 16) Запрещается размещать рядом с аппаратом источники открытого огня, например зажженные свечи.
- 17) Соблюдайте требования по утилизации элементов питания.
- 18) Устройство предназначено для использования в умеренном климате.
- 19) Устройство не должно подвергаться воздействию капель и брызг; не допускается ставить на него предметы, наполненные жидкостью, например, вазы.
- 20) Предупреждение! Во избежание травм из-за опрокидывания изделия устанавливайте устройство на ровную горизонтальную поверхность.

* Внешний вид продукта может отличаться от изображения выше*

Если штепсельная вилка на проводе питания используется для отключения устройства, в

руководстве пользователя указывается, что доступ к ней всегда должен быть свободен.

	ВНИМАНИЕ! РИСК ПОРАЖЕНИЯ ЭЛЕКТРИЧЕСКИМ ТОКОМ НЕ ОТКРЫВАТЬ!	
ВНИМАНИЕ! ВО ИЗБЕЖАНИЕ ПОРАЖЕНИЯ ЭЛЕКТРИЧЕСКИМ ТОКОМ НЕ СНИМАЙТЕ КРЫШКУ УСТРОЙСТВА (ИЛИ ЗАДНЮЮ КРЫШКУ). ВНУТРИ НЕТ ДЕТАЛЕЙ, ПОДЛЕЖАЩИХ ОБСЛУЖИВАНИЮ СИЛАМИ ПОЛЬЗОВАТЕЛЯ. ТЕХНИЧЕСКОЕ ОБСЛУЖИВАНИЕ МОЖЕТ ВЫПОЛНЯТЬСЯ ТОЛЬКО КВАЛИФИЦИРОВАННЫМИ СПЕЦИАЛИСТАМИ СЕРВИСНОЙ СЛУЖБЫ.		



Этот символ указывает на опасное напряжение внутри устройства и риск поражения электрическим током.



Этот символ указывает, что в руководстве, которое поставляется с устройством, есть важные указания по эксплуатации и обслуживанию.

ПРЕДУПРЕЖДЕНИЕ!

Чтобы снизить риск пожара и поражения электрическим током, не подвергайте изделие воздействию дождя или влаги.

ПРЕДУПРЕЖДЕНИЕ!

Не допускайте перегрева батарей, например под воздействием солнечных лучей, огня и т. п.



Этот символ показывает, что в устройстве используется двойная изоляция для защиты пользователя от опасного напряжения. При проведении обслуживания используйте только оригинальные запчасти.



Эта отметка означает, что продукт запрещается выбрасывать вместе с бытовыми отходами. Чтобы предотвратить возможный вред окружающей среде или здоровью людей от безудержного вывоза отходов, сдайте данное изделие на переработку отдельно от бытовых отходов, чтобы обеспечить повторное использование материальных ресурсов. Для утилизации отработавшего устройства используйте системы возврата и сбора либо обратитесь к продавцу, у которого приобретался продукт. Продавец обеспечит утилизацию продукта безопасным образом.

ВАЖНЫЕ ИНСТРУКЦИИ ПО ТЕХНИКЕ БЕЗОПАСНОСТИ

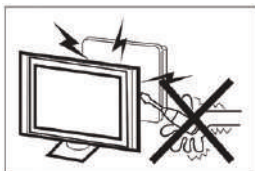

Для работы телевизора используется высокое напряжение. Не снимайте заднюю крышку устройства. Техническое обслуживание может выполняться только квалифицированными специалистами сервисной службы.

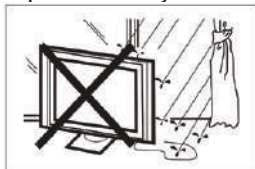

Во избежание пожара и поражения электрическим током не допускайте воздействия на телевизор дождя или влаги.



Не роняйте телевизор и не вставляйте посторонние предметы в прорези и отверстия на его корпусе. Не проливайте жидкость на телевизор.



Не закрывайте вентиляционные отверстия на задней панели устройства. Нарушение вентиляции может привести к выходу из строя электрических компонентов.



Не размещайте провод питания под телевизором.



Перед очисткой отключите телевизор от электросети и протрите его мягкой тканью без воды и химических средств.



Не вставляйте и не опирайтесь на телевизор или подставку, не толкайте их. Не оставляйте детей без присмотра. Падение устройства может привести к серьезным травмам.

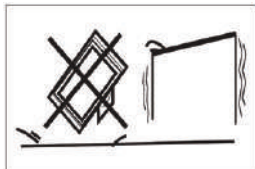

Не допускается установка телевизора на тележки, стойки, полки или столы, если они неустойчивы. При падении устройство может повредиться и травмировать пользователей.



Если телевизор не используется длительное время, рекомендуется отключить провод питания от электророзетки.



Не допускайте воздействия на телевизор прямых солнечных лучей и других источников тепла. Не устанавливайте телевизор на другие устройства, которые излучают тепло, например видеомэгафоны или усилители звука. Не ставьте на телевизор источники открытого пламени, например зажженные свечи.

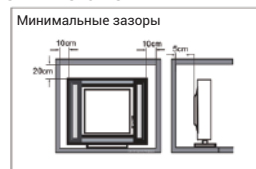

При встраивании телевизора в мебель оставляйте минимальные зазоры. Повышенная температура сокращает срок службы телевизора и является источником опасности.

Примечание: устройство предназначено для использования в умеренном климате. Внимание!

Он может упасть, став причиной серьезных травм, в том числе с летальным исходом. Многие травмы, особенно среди детей, можно предотвратить, приняв простые меры предосторожности, которые перечислены ниже:

- Используйте шкафы, стойки и методы монтажа, рекомендованные изготовителем телевизора.
 - Используйте ТОЛЬКО такую мебель, которая может служить надежной опорой для телевизора.
 - УДОСТОВЕРЬТЕСЬ, что телевизор не выступает за края опорной поверхности мебели.
 - ПРОИНФОРМИРУЙТЕ детей об опасности, которой они подвергаются, пытаясь взобраться по полкам мебели, чтобы достать до кнопок телевизора.
 - ПРОКЛАДЫВАЙТЕ провода и кабели, подключенные к телевизору, таким образом, чтобы через них нельзя было споткнуться, а также чтобы невозможно было взять или потянуть их.
 - НЕ УСТАНАВЛИВАЙТЕ телевизор на неустойчивом основании.
 - НЕ ИСПОЛЬЗУЙТЕ для установки телевизора высокие предметы мебели (шкафы, книжные полки) без обеспечения надлежащей опоры для мебели и телевизора.
 - НЕ СТАВЬТЕ телевизор на ткань или другие материалы, находящиеся между основанием телевизора и опорной поверхностью мебели.
 - НЕ РАЗМЕЩАЙТЕ предметы, которые могут привлечь внимание детей (игрушки, пульты ДУ), на телевизоре или мебели, где он расположен.
- Если вы снимаете телевизор и переставляете его в другое место, необходимо также соблюдать меры предосторожности, перечисленные выше.

ПОДГОТОВКА К ИСПОЛЬЗОВАНИЮ

ВАЖНАЯ ИНФОРМАЦИЯ! Не допускайте давления на экран, чтобы не повредить его. Гарантия производителя не распространяется на повреждения вследствие небрежного обращения или неправильной установки.

МОНТАЖ ПОДСТАВКИ

ВАЖНАЯ ИНФОРМАЦИЯ! Перед использованием телевизор необходимо установить на подставку.

1. Положите телевизор экраном вниз на ровную мягкую поверхность (одеяло, коврик, кусок ткани и т. д.), чтобы не повредить устройство.
2. Закрепите подставку на нижней панели телевизора с помощью 6 винтов.

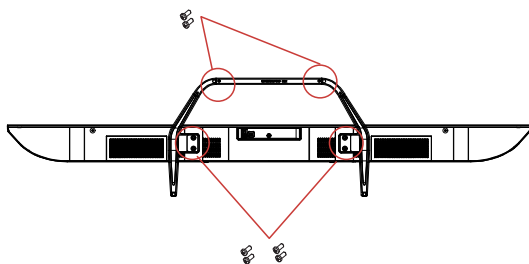

! ПРИМЕЧАНИЕ

Показан примерный внешний вид устройства.

ПОДГОТОВКА LED-ТЕЛЕВИЗОРА К УСТАНОВКЕ НА СТЕНУ

Во избежание проблем с кабелем между телевизором и стеной должно оставаться расстояние не меньше 60 мм (2,36 дюйма). Перед установкой телевизора на стену необходимо снять подставку.

В целях безопасности используйте только настенные крепления с маркировкой UL, рассчитанные на минимальный вес телевизора без подставки.

Установка настенного крепления на телевизор:

1. Выкрутите винты, которыми подставка крепится к телевизору.
2. Снимите подставку с телевизора.
3. Четырьмя винтами закрепите настенное крепление на задней панели телевизора. При установке настенного крепления соблюдайте указания из руководства пользователя к нему.

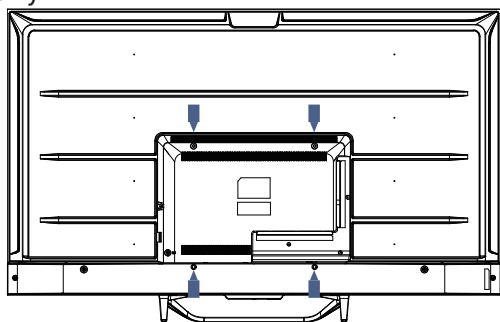

! ПРИМЕЧАНИЕ

Кронштейн для настенного крепления не входит в комплект телевизора.

4. Закрутите винты настенного крепления (M6 x 12 мм, 4 шт.) на задней панели LED-телевизора с усилием 12 кг/см.

ВКЛЮЧЕНИЕ ТЕЛЕВИЗОРА

1. Установите подставку и поставьте телевизор на надежную поверхность.

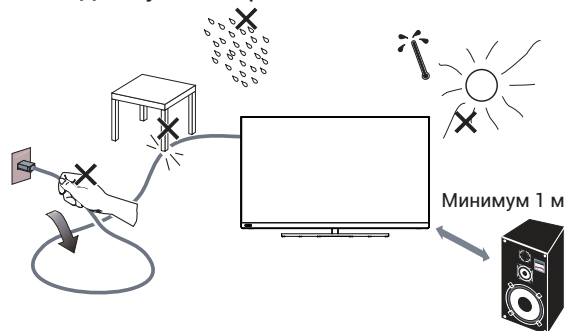

! ПРИМЕЧАНИЕ

- Убедитесь, что воздух может свободно циркулировать вокруг телевизора. Не закрывайте вентиляционные отверстия на задней панели устройства.
 - Во избежание опасных ситуаций запрещается размещать рядом с устройством или на нем источники открытого огня, например зажженные свечи.
 - Не допускайте воздействия на устройство высоких температур, прямых солнечных лучей, дождя или влаги. Не допускайте попадания на устройство брызг жидкости.
2. Подключите кабель от антенны или кабельного телевидения к разъему **ANT IN** на задней панели телевизора.
 3. Пульт ДУ:
Снимите крышку батарейного отсека. Установите 2 элемента питания (тип AAA, 1,5 В).

ВНИМАНИЕ! При установке элементов питания недопустимого типа существует риск взрыва.

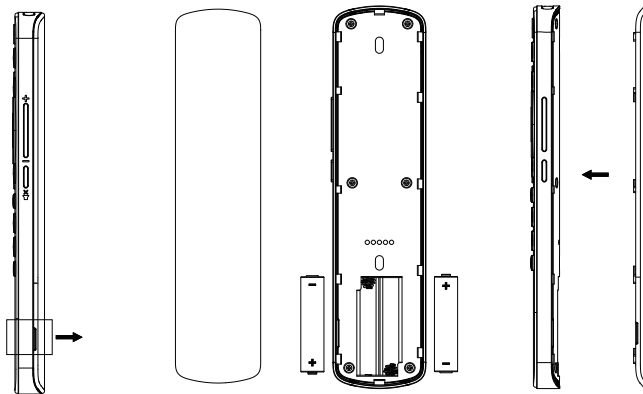

ПОДГОТОВКА К ИСПОЛЬЗОВАНИЮ

4. Питание.

Подключите вилку устройства к работающей электрической розетке.

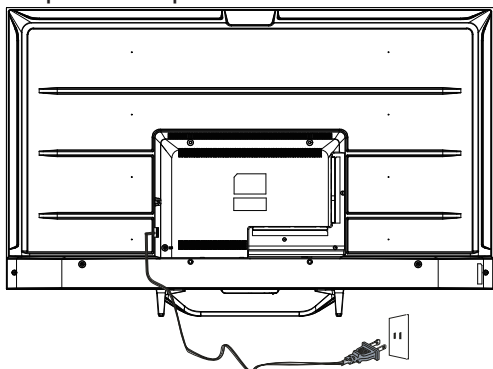

5. Включите телевизор:

Нажмите кнопку  на пульте ДУ или кнопку **POWER** на боковой панели телевизора.

ПОДКЛЮЧЕНИЕ ПЕРИФЕРИЙНЫХ УСТРОЙСТВ И ОРГАНЫ УПРАВЛЕНИЯ

КНОПКИ УПРАВЛЕНИЯ

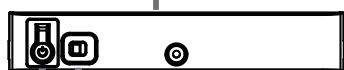
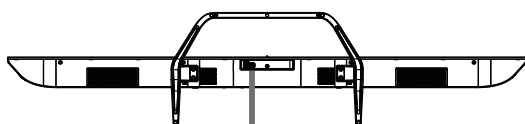
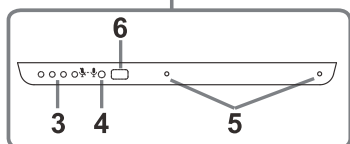
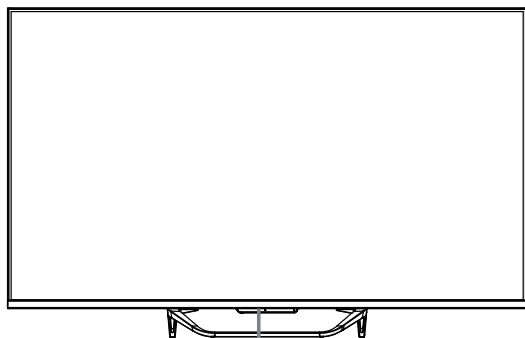

1. Включение/выключение устройства

2. Включение/выключение голосового поиска
 - 🗣 Включить удаленного ассистента
 - 🗣 Выключить удаленного ассистентаПоверните вправо, чтобы включить. Когда голосовой поиск включится, индикатор сначала загорится, а затем погаснет. Чтобы воспользоваться голосовым управлением, скажите «Окей Google». После этого на телевизоре должен загореться индикатор, и вы сможете произнести свой запрос. Поверните влево, чтобы выключить функцию голосового поиска. Индикатор будет гореть желтым светом.
3. Индикатор удаленного ассистента
4. Приемник сигнала пульта ДУ
5. Приемник голосовых команд
6. Индикатор питания

! ПРИМЕЧАНИЕ
Перед использованием голосового поиска убедитесь, что телевизор подключен к интернету.
Прежде чем использовать голосовой поиск, не забудьте включить его.
Прежде чем использовать голосовой поиск, войдите в учетную запись GOOGLE.

АКСЕССУАРЫ

- Пульт ДУ – 1 шт.
- Руководство пользователя – 1 шт.
- Винты – 6 шт.
- Руководство по быстрой настройке – 1 шт.
- Гарантийный талон – 1 шт.

ПОДКЛЮЧЕНИЕ ПЕРИФЕРИЙНЫХ УСТРОЙСТВ



Все разъемы (слева направо):
LAN, ОПТИЧЕСКИЙ, ВИДЕО, ЛЕВЫЙ, ПРАВЫЙ, HDMI4, HDMI3, HDMI2,



Все разъемы (слева направо):
HDMI1 (eARC/ARC), LNB IN (СПУТНИК), ANT IN (АНТЕННА/КАБЕЛЬНОЕ), USB1, USB2, НАУШНИКИ, CI.

ПОДКЛЮЧЕНИЕ

АУДИО-ВИДЕО ОБОРУДОВАНИЕ

К телевизору можно подключить видеомаягнитофон, DVD-проигрыватель и другое видеоборудование. При подключении такого оборудования ознакомьтесь с соответствующими руководствами. Входные разъемы на задней панели телевизора используются следующим образом:

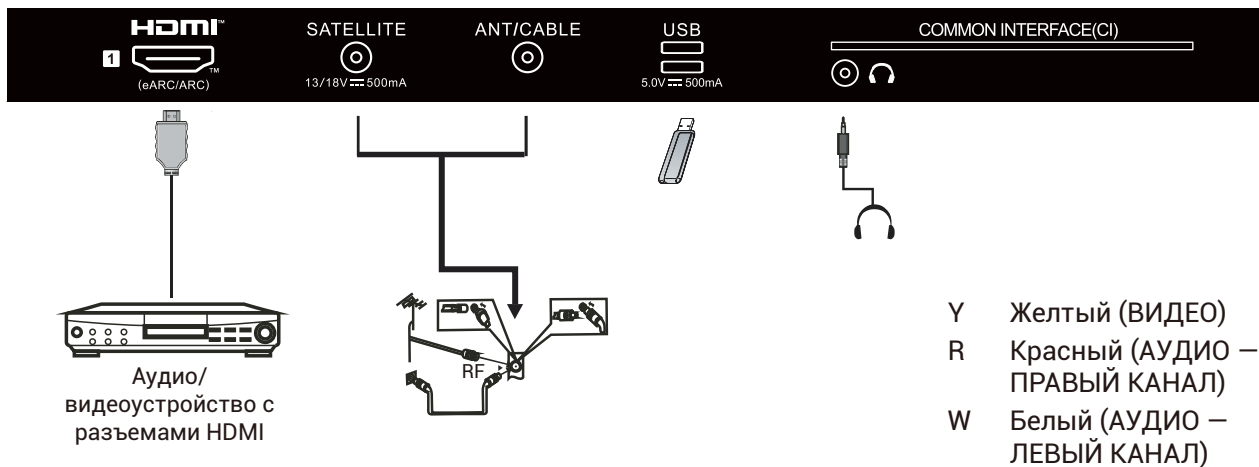
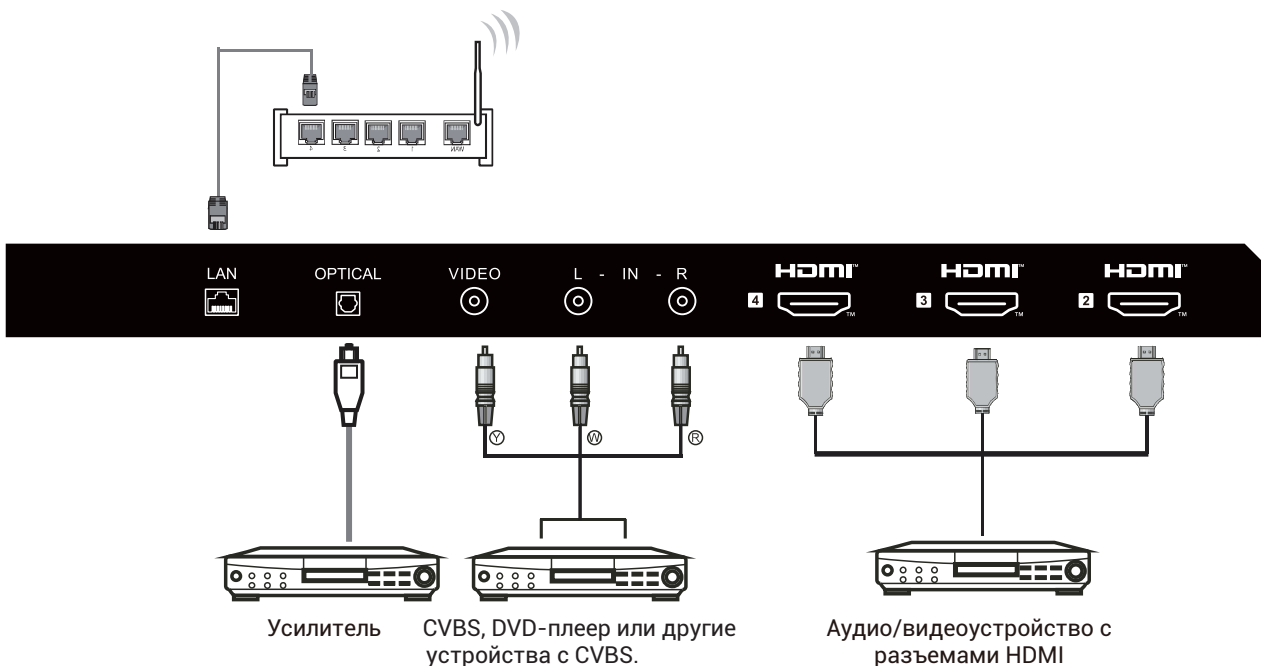

Можно подключать следующие устройства: видеомаягнитофон, музыкальный центр, DVD-проигрыватель, видекамера, игровая приставка, стереосистема и т. д.

Примечание:

Некоторые устройства могут не поддерживаться из-за нестандартного сигнала.

ИНСТРУКЦИЯ ПО ЭКСПЛУАТАЦИИ

ИСПОЛЬЗОВАНИЕ ПУЛЬТА ДУ



№	Элемент	Описание
1	 Питание	Нажмите, чтобы включить или выключить телевизор. Выключенный телевизор потребляет электроэнергию. Чтобы полностью обесточить устройство, отключите провод питания от сети.
2		Нажмите, чтобы открыть ВИРТУАЛЬНУЮ КЛАВИАТУРУ.
3		Нажмите, чтобы открыть или закрыть экранное меню.
4		Переключение учетных записей в режиме Google TV. (Данная кнопка не используется для основной настройки телевизора)
5		Нажмите для навигации в экранном меню.
6		Вернуться в предыдущее меню.
7		Нажмите, чтобы открыть главный экран.
8		Нажмите для переключения телеканалов.
9		Нажмите prime video для просмотра телепередач и фильмов онлайн (требуется подключение к интернету).
10		Нажмите, чтобы открыть Live TV.
11		Нажмите, чтобы открыть YouTube Music.
12		Нажмите, чтобы открыть NETFLIX.
13		Нажмите, чтобы открыть мультимедийный проигрыватель.
14		Нажмите, чтобы открыть Google Ассистент или начать голосовой поиск.
15		Нажмите, чтобы открыть меню настройки.
16	VOL+VOL-	Используйте кнопки VOL+ и VOL- , чтобы отрегулировать громкость.
17	OK	Ввод выбранного варианта или подтверждение выбранного действия.
18		Нажмите, чтобы отключить или включить звук.
19		Нажмите, чтобы показать электронную программу передач в режиме телевизора.
20		Нажмите для переключения телеканалов.
21		Нажмите, чтобы открыть список источников сигнала.
22		Нажмите, чтобы начать/приостановить воспроизведение мультимедиа.
23	AUDIO	Нажмите для переключения аудиодорожек.
24		Нажмите, чтобы перейти к приложениям.
25		Нажмите, чтобы открыть YouTube.

ИНСТРУКЦИЯ ПО ЭКСПЛУАТАЦИИ

НАЧАЛЬНАЯ НАСТРОЙКА

При первом включении телевизора мастер настройки поможет вам выполнить все основные настройки.

См. текстовые подсказки по начальной настройке.

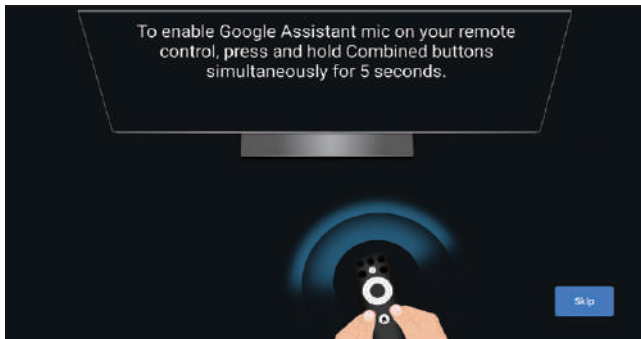

Эта функция используется для сопряжения пульта ДУ. После сопряжения вы сможете управлять телевизором с помощью пульта ДУ с поддержкой Bluetooth.

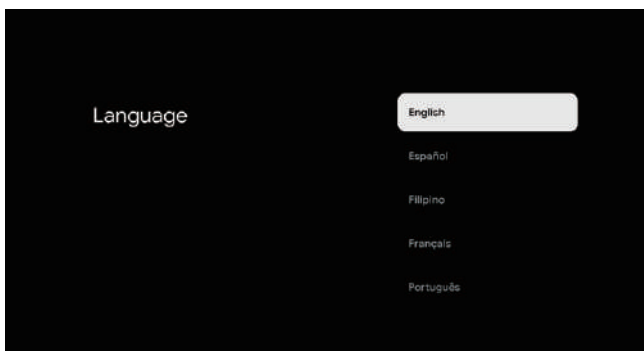

С помощью кнопок ▲/▼ выберите язык и нажмите кнопку ОК для подтверждения.

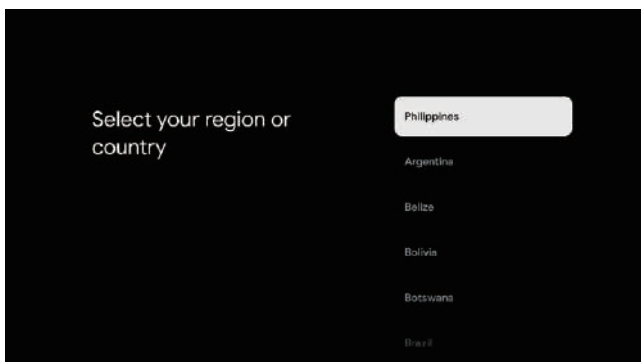

С помощью кнопок ▲/▼ выберите страну или регион, а затем нажмите кнопку ОК для подтверждения.

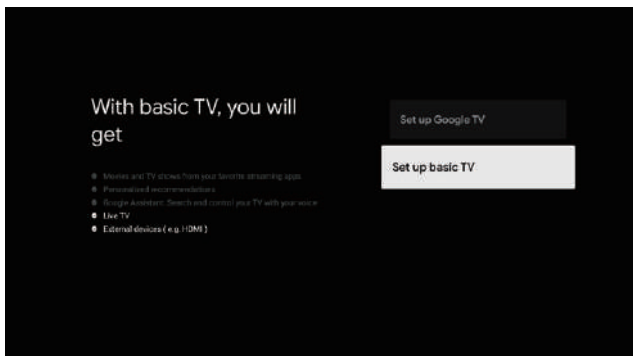

С помощью кнопок ▲/▼ выберите «Set up basic TV» (Основные настройки телевизора) и нажмите ОК для завершения настройки.

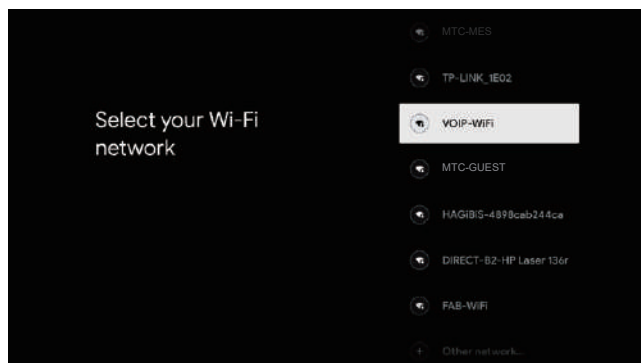

С помощью кнопок ▲/▼ выберите беспроводную сеть, к которой хотите подключиться, нажмите ОК и введите пароль.

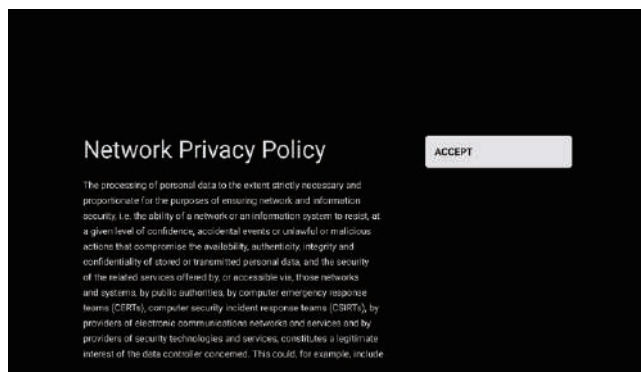

Выберите «Ассерт» (Принять), чтобы принять Политику сетевой конфиденциальности.

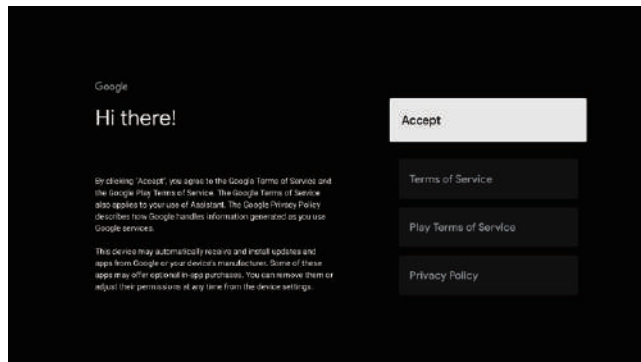

Примите Условия использования Google для улучшения работы устройства. Для подтверждения выберите «Ассерт» (Принять).

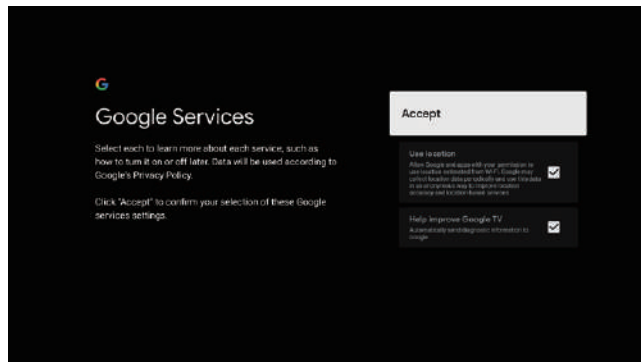

ИНСТРУКЦИЯ ПО ЭКСПЛУАТАЦИИ

Подключите сервисы Google для улучшения работы устройства. Для подтверждения выберите «Ассерт» (Принять).

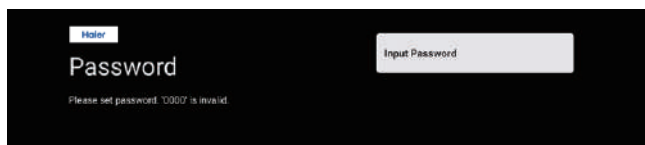

Используется для установки пароля на устройство, чтобы обеспечить безопасность и конфиденциальность.

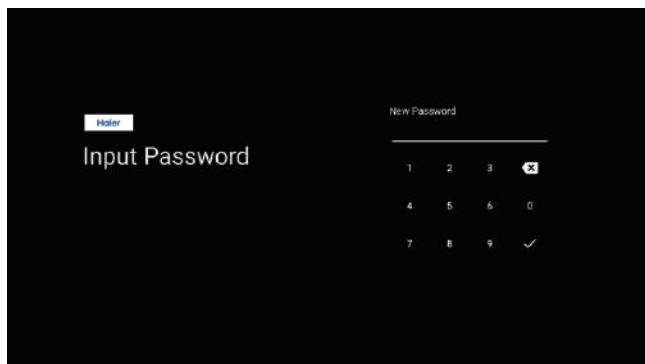

Используйте пульт ДУ или виртуальную клавиатуру, чтобы установить 4-значный пароль. После этого вы автоматически перейдете к следующему экрану.

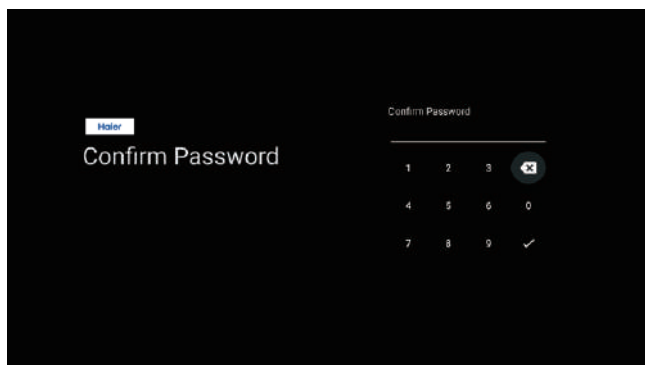

Подтвердите пароль. Для ввода и настройки пароля используйте пульт ДУ или виртуальную клавиатуру.

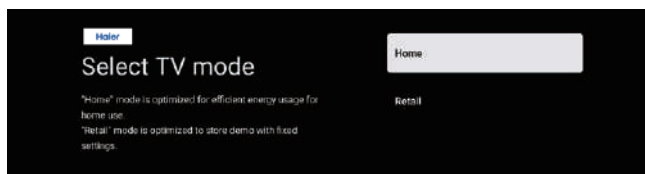

Чтобы выбрать режим, используйте кнопки ▲/▼. Выберите «Home» (Домашний) и нажмите ОК.

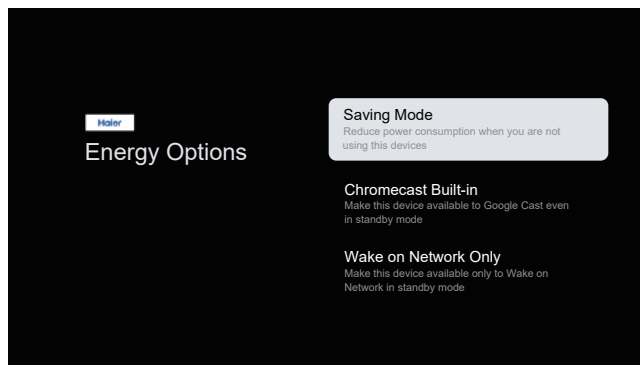

Выберите «Saving Mode» (Экономный режим) и перейдите к следующему шагу.

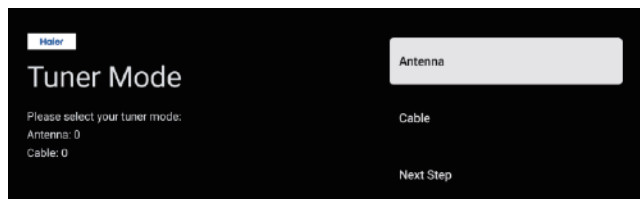

Выберите «Tuner mode» (Режим тюнера) для поиска каналов и нажмите ОК для подтверждения.

ИНСТРУКЦИЯ ПО ЭКСПЛУАТАЦИИ

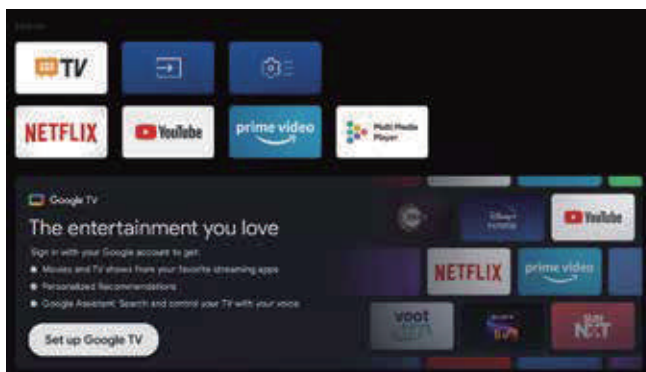

- В пользовательском интерфейсе можно переключаться между основными настройками телевизора и настройками Google TV.

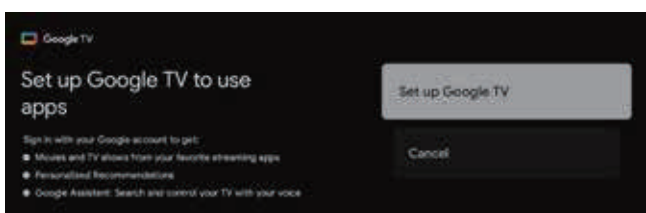

С помощью кнопок ▲/▼ выберите «Set up Google TV» (Настройка Google TV), а затем нажмите ОК для подтверждения.

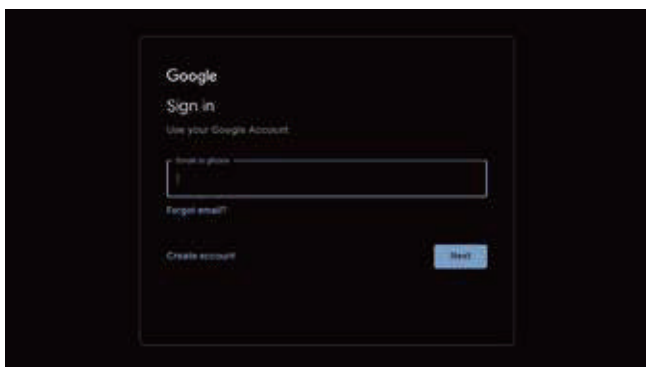

Войдите в учетную запись Google

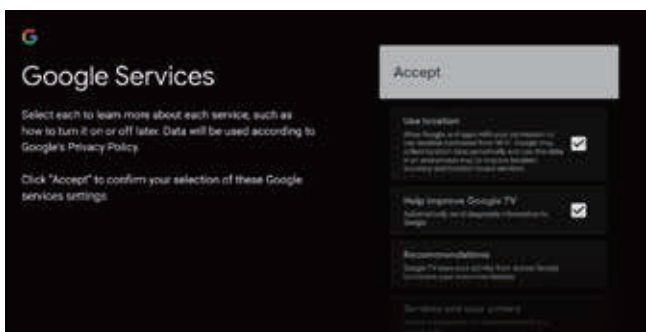
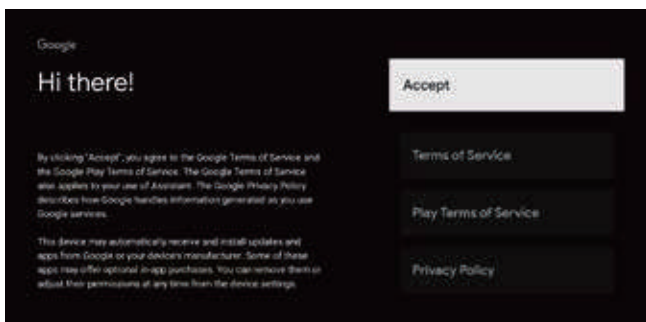

Примите Условия использования Google для улучшения работы устройства. Для подтверждения выберите «Ассерт» (Принять).

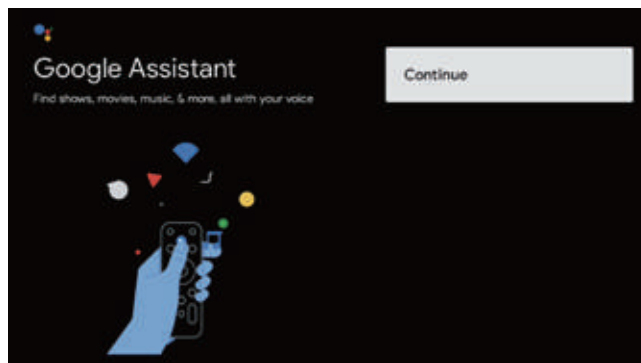

Нажмите ОК для выбора и продолжения настройки.

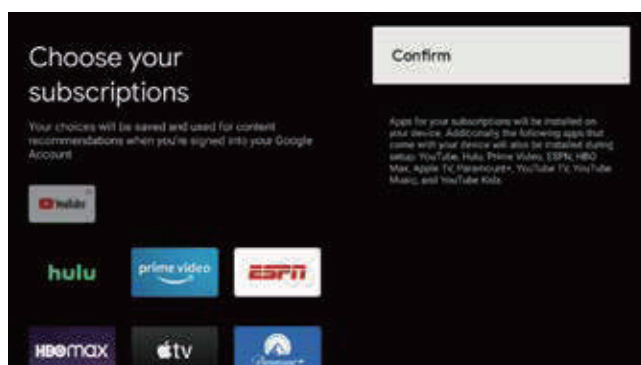

С помощью кнопок ▲/▼ выберите «Choose your subscriptions» (Выбор подписок), а затем нажмите ОК.

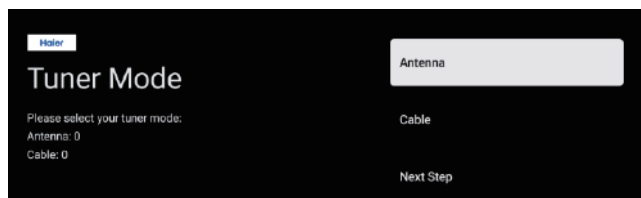

ИНСТРУКЦИЯ ПО ЭКСПЛУАТАЦИИ

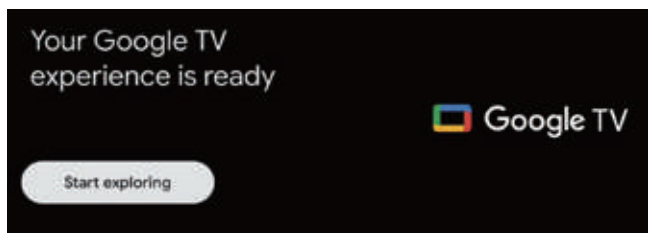

Google TV готов к работе. Нажмите ОК, чтобы начать просмотр.

ГЛАВНЫЙ ЭКРАН

После завершения работы мастера настройки можно приступить к просмотру телевизора и перейти на главный экран.

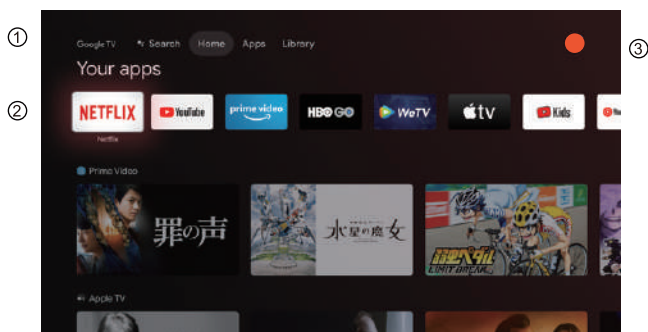

- ① **Search**: открыть Google Ассистент или начать голосовой поиск.
- Home**: открыть главный экран телевизора.
- Apps**: открыть список установленных приложений и добавить избранные приложения.
- Library**: просмотреть приобретенный и арендованный контент для вашей учетной записи
- ② Список установленных приложений и уведомления от установленных программ.

- ③ Открыть данные учетной записи, настройки, время, источники сигнала и параметры изображения.

Настройки: В этом разделе можно менять различные настройки. Подробное описание настроек приводится ниже.

Источники сигнала: Значок выбора источника сигнала.

Изображение: Настройка изображения на телевизоре. Подробные указания по настройке приводятся на странице 12.

НАВИГАЦИЯ В ЭКРАННОМ МЕНЮ

Открыть меню можно двумя способами. Первый: в режиме Live TV нажмите кнопку меню, чтобы открыть опции ТВ, и используйте **▲/▼/◀/▶**, чтобы выбрать меню настроек. Нажмите **ОК** для подтверждения. Второй: на ГЛАВНОМ ЭКРАНЕ используйте кнопку **▶**, чтобы выбрать меню . Нажмите **ОК** для подтверждения.

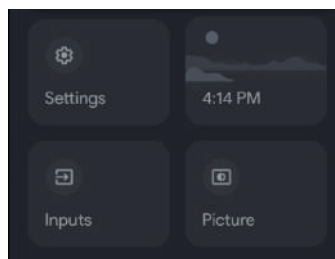
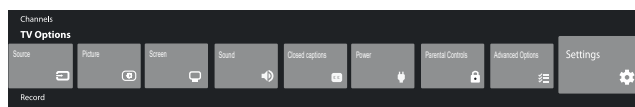

Используйте кнопки **▲/▼**, чтобы выбрать нужный параметр. Чтобы открыть меню настройки, нажмите **ОК**.

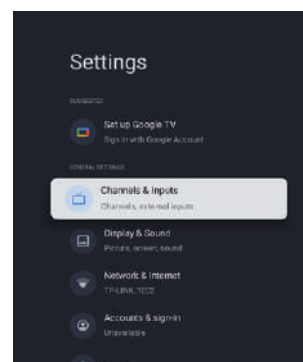

Для возврата в предыдущее меню нажмите кнопку **НАЗАД**.

Если вы уже находитесь в главном меню, то при нажатии на кнопку **НАЗАД** экранное меню будет закрыто.

ИНСТРУКЦИЯ ПО ЭКСПЛУАТАЦИИ

КАНАЛЫ

Menu -> Settings -> Channels & Inputs -> Channels
(Меню->Настройки->Каналы и входы->Каналы).

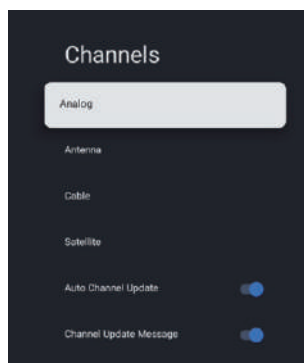

Analog/Antenna/Cable/Satellite (Аналоговые/Антенна/Кабель/Спутник) – с помощью кнопок ▲/▼ выберите вариант, а затем нажмите ОК для перехода в подменю.

Автоматическое обновление каналов (Auto Channel Update) – нажмите на кнопку ОК, чтобы выбрать ON/OFF (ВКЛ./ВЫКЛ.). При выборе ON (ВКЛ.) система будет автоматически сканировать и обновлять каналы после 5 минут в режиме ожидания.

Channel Update Message (Автоматическое обновление каналов) – нажмите кнопку ОК, чтобы выбрать ON/OFF (ВКЛ./ВЫКЛ.). При выборе ON (ВКЛ.) система отобразит сообщение об обновлении.

Примечание: доступные источники могут отличаться в зависимости от модели.

ВХОДЫ

Меню->Настройки->Каналы и входы->Входы

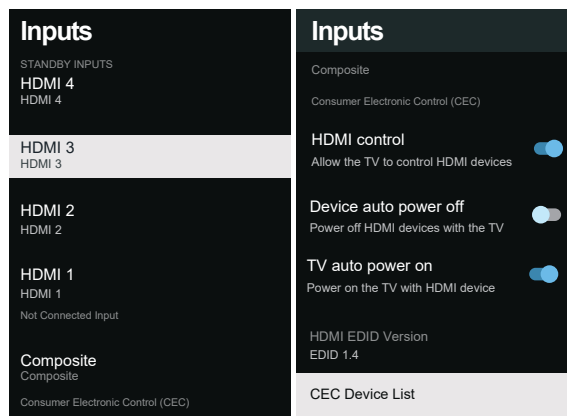

Inputs (Входы) – Используйте кнопки ▲/▼, чтобы выбрать этот пункт меню, а затем нажмите ОК, чтобы открыть подменю.

HDMI control (Управление HDMI) – Используйте кнопки ▲/▼, чтобы выбрать этот пункт меню, а затем нажмите ОК для включения/выключения.

Device auto power off (Автоматическое выключение) – Используйте кнопки ▲/▼, чтобы выбрать этот пункт меню, а затем нажмите ОК для включения/выключения.

TV auto power on (Автоматическое включение) – Используйте кнопки ▲/▼, чтобы выбрать этот пункт меню, а затем нажмите ОК для включения/выключения.

Version (Версия EDID HDMI) – отображение версии EDID.

Список устройств CEC – Используйте кнопки ▲/▼, чтобы выбрать этот пункт меню, а затем нажмите ОК, чтобы открыть подменю.

ИЗОБРАЖЕНИЕ И ЗВУК

Меню->Настройки->Изображение и звук
В этом меню можно настроить изображение, звук и аудиовыход телевизора.

ИНСТРУКЦИЯ ПО ЭКСПЛУАТАЦИИ

1. Используйте кнопки ▲/▼, чтобы выбрать нужный параметр.
2. Нажмите **OK** для подтверждения
3. По завершении настройки нажмите кнопку **НАЗАД**, чтобы вернуться в предыдущее меню.

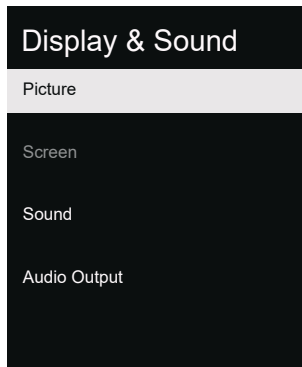

ИЗОБРАЖЕНИЕ

Меню->Настройки->Изображение и звук->Изображение.

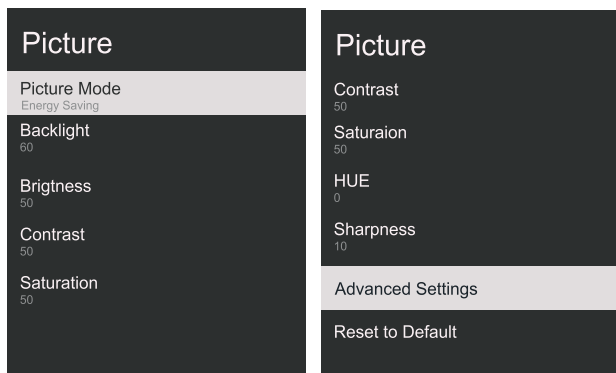

Picture Mode (Режим изображения) – Используйте кнопки ▲/▼, чтобы выбрать этот пункт меню, а затем нажмите **OK**, чтобы открыть подменю. Варианты: User (Пользовательский), Standard (Стандартный), Vivid (Яркий), Sport (Спорт), Movie (Кино), Game (Игра), Energy saving (Энергосбережение).

Backlight (Подсветка) / Brightness (Яркость) / Contrast (Контрастность) / Saturation (Насыщенность) / HUE (Оттенок) / Sharpness (Резкость) – Используйте кнопки ▲/▼, чтобы выбрать этот пункт меню, а затем нажмите **OK** для входа в него.

Нажмите ◀, чтобы уменьшить значение параметра. Нажмите ▶, чтобы увеличить значение параметра.

Advanced Settings (Расширенные настройки) – Используйте кнопки ▲/▼, чтобы выбрать этот пункт меню, а затем нажмите **OK**, чтобы открыть подменю.

Reset to Default (Сброс настроек) – Сброс всех настроек до заводских значений.

ЗВУК

Меню->Настройки->Изображение и звук->Звук.

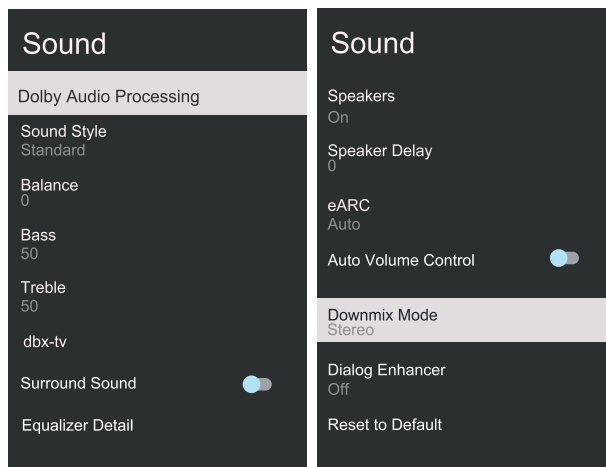

Dolby Audio processing (Обработка Dolby Audio) – Используйте кнопки ▲/▼, чтобы выбрать этот пункт меню, а затем нажмите **OK**, чтобы открыть подменю.

Sound style (Стиль звука) – Используйте кнопки ▲/▼, чтобы выбрать этот пункт меню, а затем нажмите **OK**, чтобы открыть подменю.

Варианты: User (Пользовательский), Standard (Стандартный), Night (Ночной), Sports (Спорт), Movie (Кино), Music (Музыка), News (Новости).

Balance (Баланс) / Bass (Низкие частоты) / Treble (Высокие частоты) – Используйте кнопки ▲/▼, чтобы выбрать этот пункт меню, а затем нажмите **OK** для входа в него.

Нажмите ◀, чтобы уменьшить значение параметра.

Нажмите ▶, чтобы увеличить значение параметра.

dbx-tv – Используйте кнопки ▲/▼, чтобы выбрать этот пункт меню, а затем нажмите **OK**, чтобы открыть подменю.

Surround Sound (Объемный звук) – Используйте кнопки ▲/▼, чтобы выбрать этот пункт меню, а затем нажмите **OK** для включения/выключения.

Equalizer Detail (Эквалайзер) – Используйте кнопки ▲/▼, чтобы выбрать этот пункт меню, а затем нажмите **OK**, чтобы открыть подменю.

Speakers (Динамики) – Используйте кнопки ▲/▼, чтобы выбрать этот пункт меню, а затем нажмите **OK** для включения/выключения.

Speaker Delay (Задержка звука динамика) – Используйте кнопки ▲/▼, чтобы выбрать этот пункт меню, а затем нажмите **OK** для входа в него.

Нажмите ◀, чтобы уменьшить значение параметра. Нажмите ▶, чтобы увеличить значение параметра.

eARC – Используйте кнопки ▲/▼, чтобы выбрать этот пункт меню, а затем нажмите **OK**, чтобы выбрать «Auto» (Авто) или «OFF» (ВЫКЛ.).

Auto Volume Control (Автоматический контроль громкости) – Используйте кнопки ▲/▼, чтобы

ИНСТРУКЦИЯ ПО ЭКСПЛУАТАЦИИ

выбрать этот пункт меню, а затем нажмите **ОК** для включения/выключения.

Downmix Mode (Режим понижающего микширования) – Используйте кнопки ▲/▼, чтобы выбрать этот пункт меню, а затем нажмите **ОК**, чтобы открыть подменю.

(Варианты: Stereo (Стерео), Surround (Объемный)).

Dialog Enhancer (Улучшение передачи диалогов) – Используйте кнопки ▲/▼, чтобы выбрать этот пункт меню, а затем нажмите **ОК**, чтобы открыть подменю.

(Варианты: Off (Выкл.), Low (Низкий), Medium (Средний), High (Высокий)).

Reset to Default (Сброс настроек) – Сброс всех настроек до заводских значений.

АУДИОВЫХОД

Меню->Настройки->Изображение и звук->Аудиовыход.

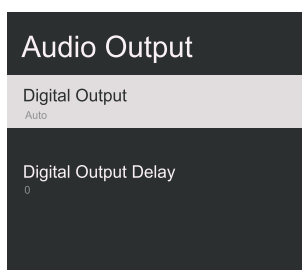

Digital Output (Цифровой выход) – Используйте кнопки ▲/▼, чтобы выбрать этот пункт меню, а затем нажмите **ОК**, чтобы открыть подменю.

(Варианты: Auto (Авто), Bypass (Байпас), PCM, Dolby Digital Plus, Dolby Audio-Dolby Digital).

Digital Output Delay (Задержка цифрового выхода) – Используйте кнопки ▲/▼, чтобы выбрать этот пункт меню, а затем нажмите **ОК** для входа в него.

Нажмите ◀, чтобы уменьшить значение параметра.

Нажмите ▶, чтобы увеличить значение параметра.

СЕТЬ

Меню->Настройки->Сеть и интернет

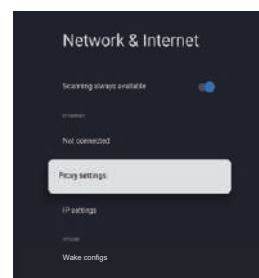
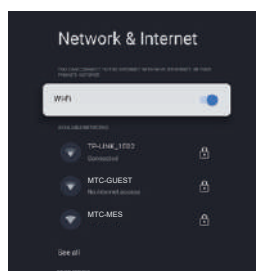

1. Используйте кнопки ▲/▼, чтобы выбрать нужный параметр.
2. Нажмите **ОК** для подтверждения.
3. После завершения настройки нажмите **ОК**, чтобы сохранить параметры и вернуться в предыдущее меню.

УЧЕТНЫЕ ЗАПИСИ И ВХОД В СИСТЕМУ

1. Меню->Настройки->Учетные записи и вход в систему.
2. На ГЛАВНОМ ЭКРАНЕ используйте кнопки ▲/▼, чтобы выбрать «Set up Google TV» (Настройка Google TV) и перейти к следующему шагу.

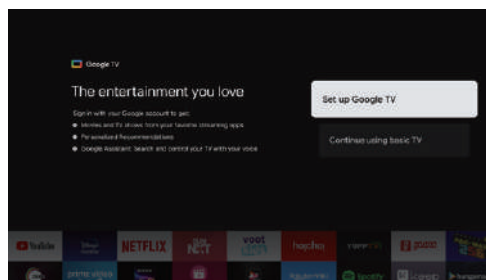

Выберите «Set up Google TV» (Настройка Google TV) и на следующем шаге введите имя учетной записи и пароль.

Следуйте инструкциям на экране для настройки соответствующих параметров.

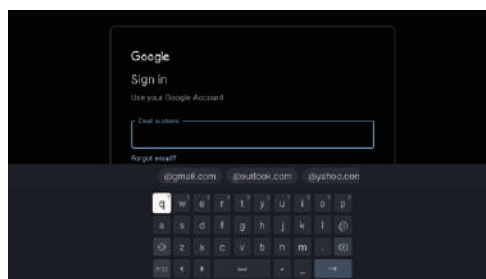

ИНСТРУКЦИЯ ПО ЭКСПЛУАТАЦИИ

КОНФИДЕНЦИАЛЬНОСТЬ

Меню->Настройки->Конфиденциальность.

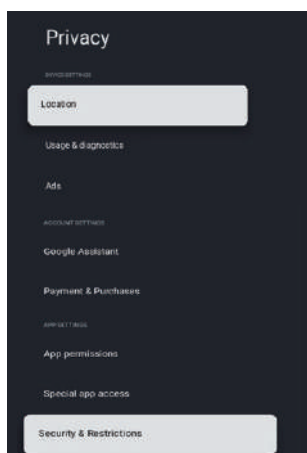

В этом меню можно настроить местоположение, использование и диагностику, а также другие параметры телевизора.

1. Используйте кнопки ▲/▼, чтобы выбрать нужный параметр.
2. Нажмите **ОК** для подтверждения.
3. По завершении настройки нажмите кнопку **НАЗАД**, чтобы вернуться в предыдущее меню.

МЕСТОПОЛОЖЕНИЕ

Меню->Настройки->Конфиденциальность->Местоположение.

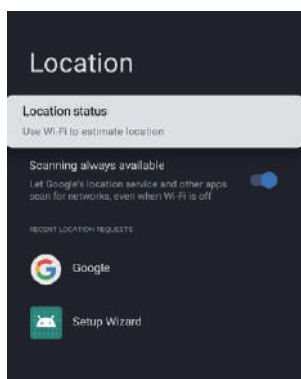

Location status (Местоположение) — Используйте кнопки ▲/▼, чтобы выбрать этот пункт меню, а затем нажмите **ОК**, чтобы открыть подменю. (Варианты: Use Wi-Fi to estimate location (Определять местоположение по Wi-Fi), Off (Выкл.)).

Scanning always available (Постоянный доступ к сканированию) — Используйте кнопки ▲/▼, чтобы выбрать этот пункт меню, а затем нажмите **ОК** для включения/выключения.

ИСПОЛЬЗОВАНИЕ И ДИАГНОСТИКА

Меню->Настройки->Конфиденциальность->Использование и диагностика

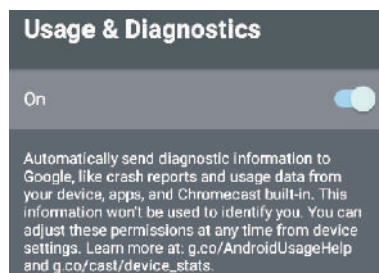

Usage & diagnostics (Использование и диагностика) — Используйте кнопки ▲/▼, чтобы выбрать этот пункт меню, а затем нажмите **ОК** для включения/выключения.

ПРИЛОЖЕНИЯ

Меню->Настройки->Приложения.

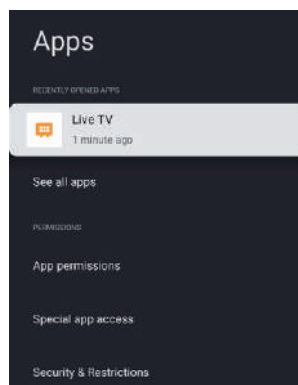

В этом меню можно настроить разрешения для приложений, а также открыть список приложений.

1. Используйте кнопки ▲/▼, чтобы выбрать нужный параметр.
2. Нажмите **ОК** для подтверждения.
3. По завершении настройки нажмите кнопку **НАЗАД**, чтобы вернуться в предыдущее меню.

СИСТЕМА

Меню->Настройки->Система.

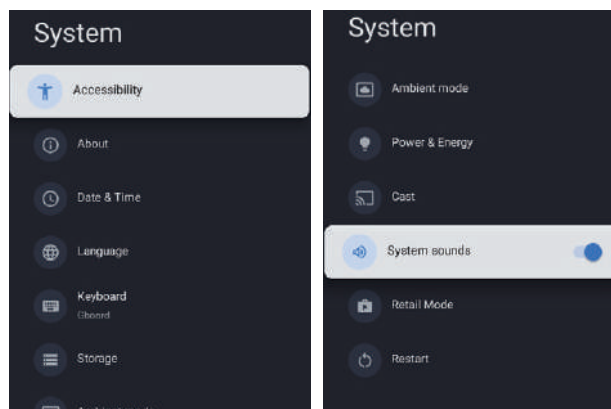

ИНСТРУКЦИЯ ПО ЭКСПЛУАТАЦИИ

В этом меню находятся сведения о телевизоре и его настройках.

1. Используйте кнопки ▲/▼, чтобы выбрать нужный параметр.
2. Нажмите **ОК** для подтверждения.
3. По завершении настройки нажмите кнопку **НАЗАД**, чтобы вернуться в предыдущее меню.

System sounds (Системные звуки) – Используйте кнопки ▲/▼, чтобы выбрать этот пункт меню, а затем нажмите **ОК** для включения/выключения. Подробное описание системы приводится ниже.

СПЕЦИАЛЬНЫЕ ВОЗМОЖНОСТИ

Меню->Настройки->Система->Специальные возможности.

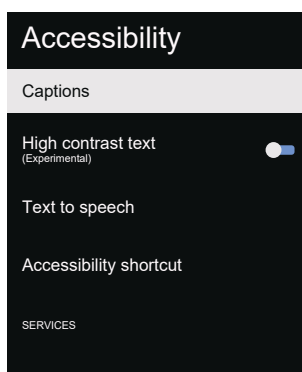

Captions (Субтитры) – Используйте кнопки ▲/▼, чтобы выбрать этот пункт меню, а затем нажмите **ОК**, чтобы открыть подменю.

High contrast text (Высококонтрастный текст) – Используйте кнопки ▲/▼, чтобы выбрать этот пункт меню, а затем нажмите **ОК** для включения/выключения.

Text to speech (Синтез речи) – Используйте кнопки ▲/▼, чтобы выбрать этот пункт меню, а затем нажмите **ОК**, чтобы открыть подменю.

Accessibility shortcut (Быстрый вызов специальных возможностей) – Используйте кнопки ▲/▼, чтобы выбрать этот пункт меню, а затем нажмите **ОК**, чтобы открыть подменю.

ОБ УСТРОЙСТВЕ

Меню->Настройки->Система->Об устройстве.

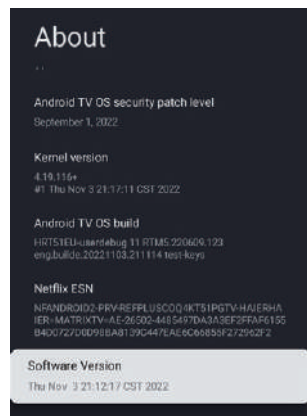
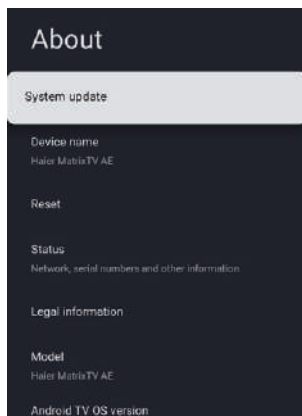

В этом меню можно обновить систему, сбросить настройки и получить информацию о телевизоре.

1. Используйте кнопки ▲/▼, чтобы выбрать нужный параметр.
2. Нажмите **ОК** для подтверждения.
3. По завершении настройки нажмите кнопку **НАЗАД**, чтобы вернуться в предыдущее меню.

ДАТА И ВРЕМЯ

Меню->Настройки->Система->Дата и время.

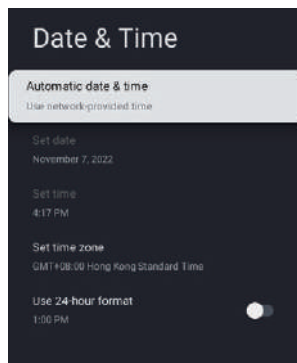

Automatic date & time (Автоматическая установка даты и времени) – Используйте кнопки ▲/▼, чтобы выбрать этот пункт меню, а затем нажмите **ОК**, чтобы открыть подменю.

(Варианты: Use network-provided time (Использование сетевого времени), Off (Выкл.)).

ПРИМЕЧАНИЕ

- Если для функции автоматической установки даты и времени выбрано значение OFF (ВЫКЛ.), вы можете установить дату и время вручную.

Set date (Установка даты) – Используйте кнопки ▲/▼, чтобы выбрать этот пункт меню, а затем нажмите **ОК**, чтобы открыть подменю.

Set time (Установка времени) – Используйте кнопки ▲/▼, чтобы выбрать этот пункт меню, а затем нажмите **ОК**, чтобы открыть подменю.

Set time zone (Установка часового пояса) – Используйте кнопки ▲/▼, чтобы выбрать этот пункт меню, а затем нажмите **ОК**, чтобы открыть подменю.

Use 24-hour format (Использовать 24-часовой формат) – Используйте кнопки ▲/▼, чтобы выбрать этот пункт меню, а затем нажмите **ОК** для включения/выключения.

ИНСТРУКЦИЯ ПО ЭКСПЛУАТАЦИИ

ЯЗЫК

Меню->Настройки->Система->Язык.

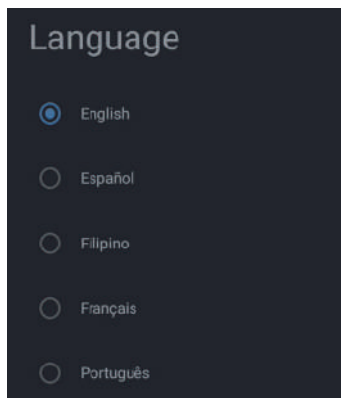

Language (Язык) — Используйте кнопки ▲/▼, чтобы выбрать этот пункт меню, а затем нажмите **ОК** для входа в меню выбора языка.

КЛАВИАТУРА

Меню->Настройки->Система-> Клавиатура.

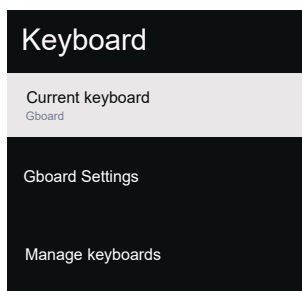

Current keyboard (Активная клавиатура) — Используйте кнопки ▲/▼, чтобы выбрать этот пункт меню, а затем нажмите **ОК**, чтобы открыть подменю.

Gboard Settings (Настройки Gboard) — Используйте кнопки ▲/▼, чтобы выбрать этот пункт меню, а затем нажмите **ОК**, чтобы открыть подменю.

Manage keyboards (Управление клавиатурами) — Используйте кнопки ▲/▼, чтобы выбрать этот пункт меню, а затем нажмите **ОК**, чтобы открыть подменю.

ХРАНИЛИЩЕ

Меню->Настройки->Система->Хранилище.

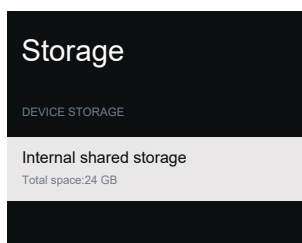

Internal shared storage (Общее внутреннее хранилище) — Используйте кнопки ▲/▼, чтобы выбрать этот пункт меню, а затем нажмите **ОК**, чтобы открыть подменю.

РЕЖИМ ОКРУЖЕНИЯ

Меню->Настройки->Система->Режим окружения.

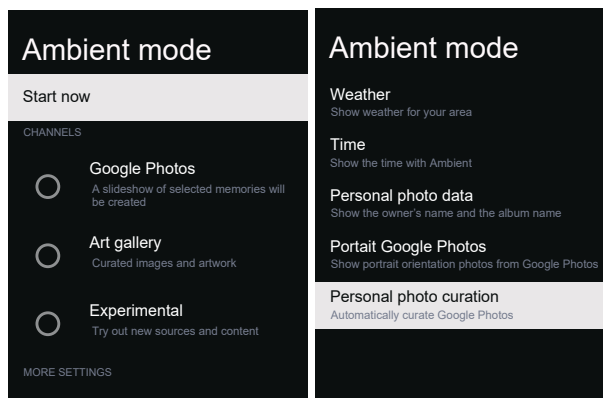

В этом меню можно настроить режим окружения.

1. Используйте кнопки ▲/▼, чтобы выбрать параметр, который хотите настроить.
2. Нажмите **ОК** для подтверждения.
3. По завершении настройки нажмите кнопку **НАЗАД**, чтобы вернуться в предыдущее меню.

ПИТАНИЕ И ЭНЕРГОПОТРЕБЛЕНИЕ

Меню->Настройки->Система->Питание и энергопотребление.

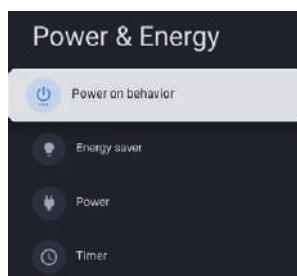

В этом меню можно настроить параметры питания и энергопотребления.

Power on behavior (Режим включения), Energy saver (Энергосбережение), Power and timer (Питание и таймер).

1. Используйте кнопки ▲/▼, чтобы выбрать нужный параметр.
2. Нажмите **ОК** для подтверждения.
3. По завершении настройки нажмите кнопку **НАЗАД**, чтобы вернуться в предыдущее меню.

РЕЖИМ ВКЛЮЧЕНИЯ

Меню->Настройки->Система->Питание-> Режим включения.

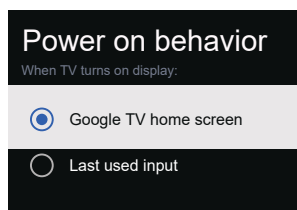

ИНСТРУКЦИЯ ПО ЭКСПЛУАТАЦИИ

Используйте кнопки ▲/▼, чтобы выбрать этот пункт меню, а затем нажмите **ОК** для подтверждения.

ЭНЕРГОСБЕРЕЖЕНИЕ

Меню->Настройки->Система->Питание->Энергосбережение.

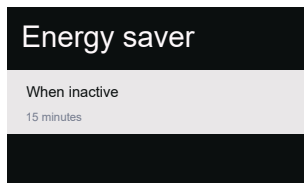

When inactive (При отсутствии действий) – Используйте кнопки ▲/▼, чтобы выбрать этот пункт меню, а затем нажмите **ОК**, чтобы открыть подменю.

(Варианты: 15 minutes (15 минут), 20 minutes (20 минут), 30 minutes (30 минут), 1 hour (1 час), 4 hours (4 часа), 8 hours (8 часов), 12 hours (12 часов), 24 hours (24 часа), Never (Никогда)).

ПИТАНИЕ

Меню->Настройки->Система->Питание->Питание.

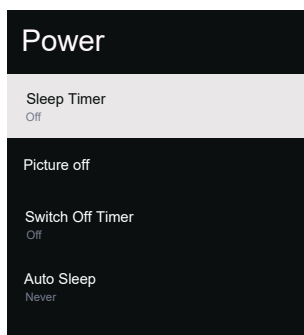

Sleep Timer (Таймер спящего режима) – Используйте кнопки ▲/▼, чтобы выбрать этот пункт меню, а затем нажмите **ОК**, чтобы открыть подменю.

Варианты: Off (Выкл.), 10 minutes (10 минут), 20 minutes (20 минут), 30 minutes (30 минут), 40 minutes (40 минут), 50 minutes (50 минут), 60 minutes (60 минут), 90 minutes (90 минут), 120 minutes (120 минут).

Picture off (Выключение изображения) – Используйте кнопки ▲/▼, чтобы выбрать этот пункт меню, а затем нажмите **ОК** для подтверждения.

Switch off timer (Таймер отключения) – Используйте кнопки ▲/▼, чтобы выбрать этот пункт меню, а затем нажмите **ОК**, чтобы открыть подменю.

Варианты: Off (Выкл.), 30 minutes (30 минут), 60 minutes (60 минут), 90 minutes (90 минут), 120 minutes (120 минут), 150 minutes (150 минут), 180 minutes (180 минут), 210 minutes (210 минут),

240 minutes (240 минут).

Auto Sleep (Автоматический переход в спящий режим) – Используйте кнопки ▲/▼, чтобы выбрать этот пункт меню, а затем нажмите **ОК**, чтобы открыть подменю.

(Варианты: Never (Никогда), 4 hours (4 часа), 6 hours (6 часов), 8 hours (8 часов)).

ТАЙМЕР

Меню->Настройки->Система->Питание->Таймер.

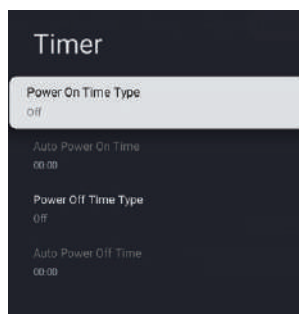

Power On Time Type (Тип таймера включения) – Используйте кнопки ▲/▼, чтобы выбрать этот пункт меню, а затем нажмите **ОК**, чтобы выбрать OFF (Выкл.), ON (Вкл.) или ONCE (Один раз).

Auto Power On Time (Таймер автоматического включения) – Используйте кнопки ▲/▼, чтобы выбрать этот пункт меню, а затем нажмите **ОК**, чтобы открыть подменю.

Power Off Time Type (Тип таймера выключения) – Используйте кнопки ▲/▼, чтобы выбрать этот пункт меню, а затем нажмите **ОК**, чтобы выбрать OFF (Выкл.), ON (Вкл.) или ONCE (Один раз).

Auto Power Off Time (Таймер автоматического выключения) – Используйте кнопки ▲/▼, чтобы выбрать этот пункт меню, а затем нажмите **ОК**, чтобы открыть подменю.

ТРАНСЛЯЦИЯ

Меню->Настройки->Система-> Трансляция.

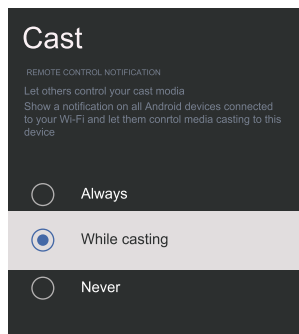

1. Используйте кнопки ▲/▼, чтобы выбрать нужный параметр.
2. Нажмите **ОК** для подтверждения.
3. Для возврата в предыдущее меню нажмите кнопку НАЗАД.

РЕЖИМ МАГАЗИНА

Меню->Настройки->Система->Режим магазина.

ИНСТРУКЦИЯ ПО ЭКСПЛУАТАЦИИ

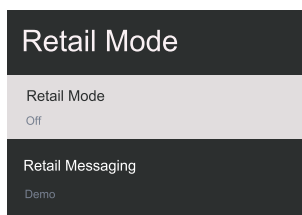

Retail mode (Режим магазина) – Используйте кнопки ▲/▼, чтобы выбрать этот пункт меню, а затем нажмите **OK** для включения/выключения.

Retail messaging (Сообщения магазина) – Используйте кнопки ▲/▼, чтобы выбрать этот пункт меню, а затем нажмите **OK**, чтобы открыть подменю. (Примечание: Demo (Демо), e-POP, e-POP + Demo (e-POP + Демо)).

ПЕРЕЗАГРУЗКА

Меню->Настройки->Система->Перезагрузка.
Нажмите **OK** для перехода в подменю.
Варианты: перезагрузить и отменить.

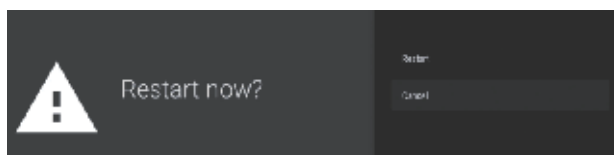

ПУЛЬТЫ ДУ И ПРИНАДЛЕЖНОСТИ

Меню->Настройки->Пульты ДУ и принадлежности

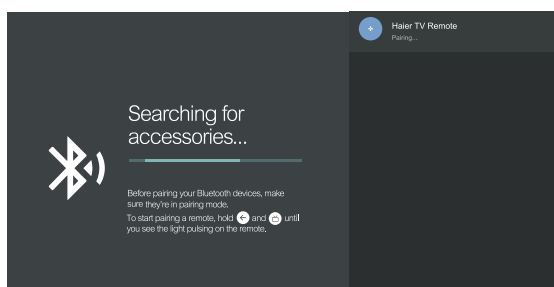
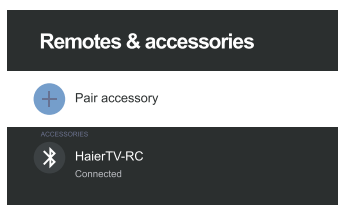

В этом меню можно настраивать сопряжения с устройствами Bluetooth.

1. Нажмите и удерживайте кнопки ← и 📺 в нижней части пульта в течение 5 секунд.
2. Когда светодиодный индикатор начнет мигать, отпустите кнопки. Пульт ДУ отправит в телевизор запрос сопряжения, и сведения о пульте появятся в правой части экрана.
3. Нажмите **OK**, чтобы показать результат сопряжения. Если на экране появится соответствующее сообщение, значит, сопряжение установлено.

4. Если появится сообщение об отсутствии сопряжения, значит, сопряжение не установлено. Подождите 30 секунд и снова нажмите и удерживайте кнопки ← и 📺 в нижней части пульта ДУ в течение 5 секунд, чтобы повторить процедуру сопряжения.
5. Для возврата в предыдущее меню нажмите кнопку ←.

ИСПОЛЬЗОВАНИЕ МУЛЬТИМЕДИЙНОГО ПРОИГРЫВАТЕЛЯ

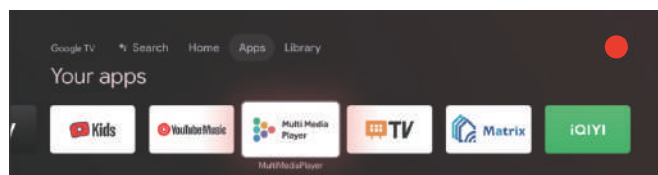

1. На ГЛАВНОМ ЭКРАНЕ или в разделе **ПРИЛОЖЕНИЯ** используйте кнопки ▲/▼/◀/▶, чтобы выбрать приложение Multi Media Player (Мультимедийный проигрыватель)

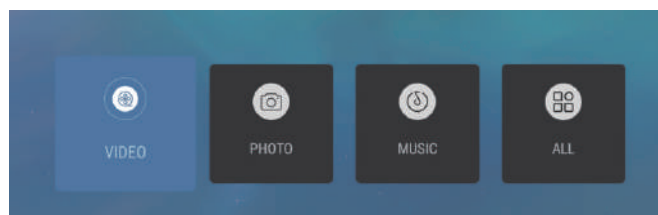

2. Нажмите **OK**, чтобы открыть мультимедийный проигрыватель и просматривать видео, фото или аудиозаписи. Установив в соответствующий разъем USB-накопитель, вы сможете просматривать находящиеся на нем файлы (файловая система FAT32).

ПРИМЕЧАНИЕ

Меню может выглядеть иначе в зависимости от даты покупки телевизора.

ПОИСК И УСТРАНЕНИЕ НЕИСПРАВНОСТЕЙ

Перед обращением в службу поддержки выполните следующие процедуры проверки. Эти советы помогут сэкономить время и деньги, так как установка и настройка телевизора не покрываются гарантией производителя.

Проблемы	Проверьте или выполните следующее
Изображение с тенью или двойное изображение.	<ul style="list-style-type: none">Высотные здания или рельеф создают помехи для антенны. Качество изображения может улучшиться при использовании остронаправленной антенны.
Телевизор не включается	<ul style="list-style-type: none">Убедитесь, что провод питания телевизора подключен к электророзетке.Отключите телевизор от электросети и подождите 60 секунд. Снова подключите телевизор к электросети и включите питание.
Отсутствует изображение	<ul style="list-style-type: none">Проверьте подключение антенны на задней панели телевизора.Проблемы могут быть на станции телевидения. Переключите канал.Отрегулируйте контрастность и яркость.Проверьте настройки скрытых субтитров. Некоторые текстовые режимы могут блокировать экран.
Изображение в норме, но нет звука	<ul style="list-style-type: none">Нажмите кнопку ВЫКЛЮЧЕНИЯ ЗВУКА на пульте ДУ и убедитесь, что звук включен.
Звук в норме, но плохие цвета	<ul style="list-style-type: none">Отрегулируйте контрастность, цвет и яркость.
Плохое изображение	<ul style="list-style-type: none">Плохое изображение может быть связано с одновременным подключением к телевизору активной камеры S-VHS или видеокамеры, а также других периферийных устройств. Отключите одно из периферийных устройств.
Помехи на изображении	<ul style="list-style-type: none">Проверьте подключение антенны.
Горизонтальная прерывистая линия	<ul style="list-style-type: none">Это может быть вызвано электрическими помехами (например, от фена, неоновых ламп и т. д., находящихся поблизости). Выключите устройство, создающее помехи.
Телевизор не реагирует на команды пульта ДУ	<ul style="list-style-type: none">Проверьте элементы питания. При необходимости замените.Протрите линзу датчика ДУ на телевизоре.
Темные или светящиеся пиксели (точки)	<ul style="list-style-type: none">Телевизор изготовлен с использованием высокоточных технологий. Тем не менее иногда пиксели могут отображаться некорректно. Такие явления характерны для данного продукта, и они не считаются дефектом.

ПРИМЕЧАНИЕ

- Матрица данного продукта состоит из мельчайших пикселей, для производства которых используются сложные технологии. Несмотря на это, на экране может быть несколько темных или светящихся пикселей. Они никак не влияют на работу устройства в целом.



HDMI, HDMI High-Definition Multimedia Interface, HDMI Trade Dress и логотипы HDMI являются товарными знаками или зарегистрированными товарными знаками HDMI Licensing Administrator, Inc.



Dolby, Dolby Vision, Dolby Atmos, Dolby Audio, а также значок «двойная буква D» являются товарными знаками Dolby Laboratories Licensing Corporation. Произведено по лицензии Dolby Laboratories. Конфиденциальные неопубликованные материалы. Авторское право ©2012-2024 Dolby Laboratories. Все авторские права защищены.

ХАРАКТЕРИСТИКИ ПРОДУКТА

43-дюймовый LED-телевизор UHD

Качество телевизионного изображения:	UHD Интегрированное цифровое. Размер экрана: 108 см Разрешение 3840x2160 пикселей, 60 Гц.
ТВ-система:	PAL-B/G, SECAM-B/G
Декодер DTV-тюнера	DVB-T, DVB-C, DVB-T2, DVB-S2 QAM-модуляция 16/32/64/128/256 MPEG2, MPEG4, H.265
Возможности подключения:	1 оптический порт 2 USB-порта 1 LAN 4 разъема HDMI 1 разъем ВИДЕО 1 левый аудиоразъем 1 правый аудиоразъем 2 разъема RF 1 разъем для наушников 1 CI-слот Поддерживаемые системы: PAL+SECAM Количество каналов в памяти: 1000 (цифровое ТВ), 100 (аналоговое ТВ) ТВ (RF): сопротивление 75Ω Видеовход AV: 75 Ω, 1V-P, RCA Аудиовход AV: 20 кΩ, 500 мВ RMS Видеовход HDMI: 480i, 480p, 720p, 1080i, 1080p, 2160p Wi-Fi: Стандартное: IEEE 802.11a/b/g/n/ac, Частота: 2,4 ГГц/5 ГГц Bluetooth: V5.1
Качество звука:	Стереозвуковая система. Выходная мощность 2 x 10 Вт RMS.
Потребление мощности в режиме ожидания	≤0,5 Вт
Цифровые функции:	Интерактивное цифровое взаимодействие. Цифровой текст. Доступны субтитры цифрового видеовещания (DVB). Автоматическая настройка. Автоматический поиск новых каналов. Программа текущих и предстоящих передач. Электронная программа передач на 7 дней (EPG). CI-слот. Совместимость с аудиоописанием.
Дополнительные характеристики:	Тюнер UHF/VHF; таймер режима сна; родительский контроль; изображение и текст Пульт ДУ работает от 2 элементов питания типа «AAA». Размер крепления VESA: 300 x 300 мм Размер упаковки (Ш x В x Г): 1075 x 652 x 142 мм Размер телевизора (Ш x В x Г) с подставкой: 957,2 x 607,4 x 240,7 мм Размер телевизора (Ш x В x Г) без подставки: 957,2 x 566,7 x 86,6 мм Вес в упаковке: 10 кг Вес телевизора с подставкой: 7,2 кг Вес телевизора без подставки: 6,8 кг

* Характеристики компонентов телевизора представлены только для справки.
Возможны расхождения из-за усовершенствования продукта.
Дизайн и технические характеристики могут быть изменены без предварительного уведомления.

ХАРАКТЕРИСТИКИ ПРОДУКТА

50-дюймовый LED-телевизор UHD

Качество телевизионного изображения:	UHD Интегрированное цифровое. Размер экрана: 126 см Разрешение 3840x2160 пикселей, 60 Гц.
ТВ-система:	PAL-B/G, SECAM-B/G
Декодер DTV-тюнера	DVB-T, DVB-C, DVB-T2, DVB-S2 QAM-модуляция 16/32/64/128/256 MPEG2, MPEG4, H.265
Возможности подключения:	1 оптический порт 2 USB-порта 1 LAN 4 разъема HDMI 1 разъем ВИДЕО 1 левый аудиоразъем 1 правый аудиоразъем 2 разъема RF 1 разъем для наушников 1 CI-слот Поддерживаемые системы: PAL+SECAM Количество каналов в памяти: 1000 (цифровое ТВ), 100 (аналоговое ТВ) ТВ (RF): сопротивление 75 Ω Видеовход AV: 75 Ω, 1V-P, RCA Аудиовход AV: 20 кΩ, 500 мВ RMS Видеовход HDMI: 480i, 480p, 720p, 1080i, 1080p, 2160p Wi-Fi: Стандартное: IEEE 802.11a/b/g/n/ac, Частота: 2,4 ГГц/5 ГГц Bluetooth: V5.1
Качество звука:	Стереозвуковая система. Выходная мощность 2 x 13.5 Вт RMS.
Потребление мощности в режиме ожидания	≤0,5 Вт
Цифровые функции:	Интерактивное цифровое взаимодействие. Цифровой текст. Доступны субтитры цифрового видеовещания (DVB). Автоматическая настройка. Автоматический поиск новых каналов. Программа текущих и предстоящих передач. Электронная программа передач на 7 дней (EPG). CI-слот. Совместимость с аудиоописанием.
Дополнительные характеристики:	Тюнер UHF/VHF; таймер режима сна; родительский контроль; изображение и текст Пульт ДУ работает от 2 элементов питания типа «AAA». Размер крепления VESA: 300 x 300 мм Размер упаковки (Ш x В x Г): 1250 x 760 x 144 мм Размер телевизора (Ш x В x Г) с подставкой: 1111,2 x 710,5 x 277,2 мм Размер телевизора (Ш x В x Г) без подставки: 1111,2 x 651,8 x 88 мм Вес в упаковке: 13,5 кг Вес телевизора с подставкой: 10 кг Вес телевизора без подставки: 9,5 кг

* Характеристики компонентов телевизора представлены только для справки.
Возможны расхождения из-за усовершенствования продукта.
Дизайн и технические характеристики могут быть изменены без предварительного уведомления.

ХАРАКТЕРИСТИКИ ПРОДУКТА

55-дюймовый LED-телевизор UHD

Качество телевизионного изображения:	UHD Интегрированное цифровое. Размер экрана: 139 см Разрешение 3840x2160 пикселей, 60 Гц.
ТВ-система:	PAL-B/G, SECAM-B/G
Декодер DTV-тюнера	DVB-T, DVB-C, DVB-T2, DVB-S2 QAM-модуляция 16/32/64/128/256 MPEG2, MPEG4, H.265
Возможности подключения:	1 оптический порт 2 USB-порта 1 LAN 4 разъема HDMI 1 разъем ВИДЕО 1 левый аудиоразъем 1 правый аудиоразъем 2 разъема RF 1 разъем для наушников 1 CI-слот Поддерживаемые системы: PAL+SECAM Количество каналов в памяти: 1000 (цифровое ТВ), 100 (аналоговое ТВ) ТВ (RF): сопротивление 75Ω Видеовход AV: 75 Ω, 1V-P, RCA Аудиовход AV: 20 кΩ, 500 мВ RMS Видеовход HDMI: 480i, 480p, 720p, 1080i, 1080p, 2160p Wi-Fi: Стандартное: IEEE 802.11a/b/g/n/ac, Частота: 2,4 ГГц/5 ГГц Bluetooth: V5.1
Качество звука:	Стереозвуковая система. Выходная мощность 2 x 13,5 Вт RMS.
Потребление мощности в режиме ожидания	≤0,5 Вт
Цифровые функции:	Интерактивное цифровое взаимодействие. Цифровой текст. Доступны субтитры цифрового видеовещания (DVB). Автоматическая настройка. Автоматический поиск новых каналов. Программа текущих и предстоящих передач. Электронная программа передач на 7 дней (EPG). CI-слот. Совместимость с аудиоописанием.
Дополнительные характеристики:	Тюнер UHF/VHF; таймер режима сна; родительский контроль; изображение и текст Пульт ДУ работает от 2 элементов питания типа «AAA». Размер крепления VESA: 300 x 300 мм Размер упаковки (Ш x В x Г): 1350 x 837 x 144 мм Размер телевизора (Ш x В x Г) с подставкой: 1225,8 x 777,3 x 277,2 мм Размер телевизора (Ш x В x Г) без подставки: 1225,8 x 719,4 x 88,1 мм Вес в упаковке: 16,4 кг Вес телевизора с подставкой: 11,9 кг Вес телевизора без подставки: 11,4 кг

* Характеристики компонентов телевизора представлены только для справки.
Возможны расхождения из-за усовершенствования продукта.
Дизайн и технические характеристики могут быть изменены без предварительного уведомления.

ХАРАКТЕРИСТИКИ ПРОДУКТА

65-дюймовый LED-телевизор UHD

Качество телевизионного изображения:	UHD Интегрированное цифровое. Размер экрана: 164 см Разрешение 3840x2160 пикселей, 60 Гц.
ТВ-система:	PAL-B/G, SECAM-B/G
Декодер DTV-тюнера	DVB-T, DVB-C, DVB-T2, DVB-S2 QAM-модуляция 16/32/64/128/256 MPEG2, MPEG4, H.265
Возможности подключения:	1 оптический порт 2 USB-порта 1 LAN 4 разъема HDMI 1 разъем ВИДЕО 1 левый аудиоразъем 1 правый аудиоразъем 2 разъема RF 1 разъем для наушников 1 CI-слот Поддерживаемые системы: PAL+SECAM Количество каналов в памяти: 1000 (цифровое ТВ), 100 (аналоговое ТВ) ТВ (RF): сопротивление 75 Ω Видеовход AV: 75 Ω, 1V-P, RCA Аудиовход AV: 20 кΩ, 500 мВ RMS Видеовход HDMI: 480i, 480p, 720p, 1080i, 1080p, 2160p Wi-Fi: Стандартное: IEEE 802.11a/b/g/n/ac, Частота: 2,4 ГГц/5 ГГц Bluetooth: V5.1
Качество звука:	Стереозвуковая система. Выходная мощность 2 x 13,5 Вт RMS.
Потребление мощности в режиме ожидания	≤0,5 Вт
Цифровые функции:	Интерактивное цифровое взаимодействие. Цифровой текст. Доступны субтитры цифрового видеовещания (DVB). Автоматическая настройка. Автоматический поиск новых каналов. Программа текущих и предстоящих передач. Электронная программа передач на 7 дней (EPG). CI-слот. Совместимость с аудиоописанием.
Дополнительные характеристики:	Тюнер UHF/VHF; таймер режима сна; родительский контроль; изображение и текст Пульт ДУ работает от 2 элементов питания типа «AAA». Размер крепления VESA: 400 x 300 мм Размер упаковки (Ш x В x Г): 1600 x 960 x 164 мм Размер телевизора (Ш x В x Г) с подставкой: 1446,4 x 904,7 x 313,8 мм Размер телевизора (Ш x В x Г) без подставки: 1446,4 x 841,3 x 85,1 мм Вес в упаковке: 24 кг Вес телевизора с подставкой: 17,2 кг Вес телевизора без подставки: 16,5 кг

* Характеристики компонентов телевизора представлены только для справки.

Возможны расхождения из-за усовершенствования продукта.

Дизайн и технические характеристики могут быть изменены без предварительного уведомления.

Haier

Haier

Inspirerad livsstil

Användarhandbok

MODELLER:

H43Q80FUX

H50Q80FUX

H55Q80FUX

H65Q80FUX



Illustrationer i den här guiden är endast som referens och kan skilja sig från den faktiska produkten. Produktdesign och specifikationer kan ändras utan föregående meddelande.

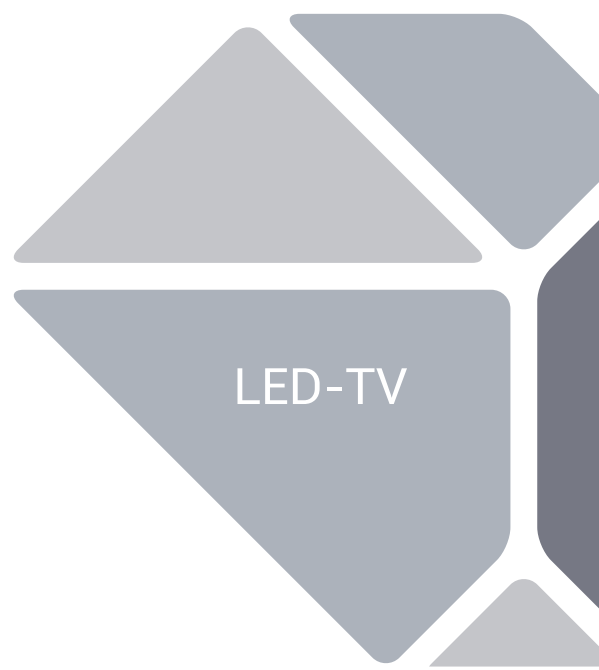

INNEHÅLLSFÖRTECKNING

1. VIKTIGA SÄKERHETSANVISNINGAR	1
2. FÖRBEREDELSE.....	3
3. ANSLUTA KRINGUTRUSTNING OCH REGLAGE.....	4
4. ANSLUTNINGAR.....	5
5. BRUKSANVISNINGAR	6
6. FELSÖKNING	19
7. PRODUKTSPECIFIKATIONER.....	20



Illustrationer i den här guiden är endast som referens och kan skilja sig från den faktiska produkten. Produktdesign och specifikationer kan ändras utan föregående meddelande.

VIKTIGA SÄKERHETSANVISNINGAR

- 1) Läs dessa anvisningar.
- 2) Förvara dessa anvisningar.
- 3) Ta hänsyn till alla varningar.
- 4) Följ alla instruktioner.
- 5) Använd inte den här apparaten nära vatten.
- 6) Rengör endast med en torr trasa.
- 7) Blockera inte några ventilationsöppningar och montera enligt anvisningarna.
- 8) Montera inte nära en värmekälla såsom strålningselement, värmeelement, spisar eller andra apparater (inklusive förstärkare) som producerar värme.
- 9) Motgå inte säkerhetssyftet med den jordade kontakten. Kontakta en elektriker för att byta ut föråldrade eluttag om den medföljande kontakten inte passar i ditt eluttag.
- 10) Skydda strömsladden från att trampas på eller att den kläms, särskilt vid eluttaget och där den ansluts till TV-apparaten.
- 11) Använd endast tillbehör/kringutrustning som har godkänts av tillverkaren.
- 12) Koppla bort den här apparaten vid åskväder eller om den inte används under längre tidsperiod.
- 13) Överlåt all service till kvalificerad servicepersonal. Service krävs när apparaten har skadats på något sätt såsom om strömsladden eller kontakten är skadad, vätska har spillts på eller föremål fallit in i den, när den har utsatts för regn eller fukt och inte fungerar normalt eller har tappats.
- 14) Kontakten används för att koppla bort enheten och möjligheten att koppla bort ska alltid vara lätt tillgänglig.
- 15) Ventilationen bör inte hindras genom att täcka ventilationsöppningarna med föremål såsom tidningar, bordsdukar eller gardiner osv.
- 16) Inga källor med öppen eld såsom tända ljus bör placeras på apparaten.
- 17) Miljöaspekterna bör uppmärksammas när det gäller kassering av batterier.
- 18) Användningen av apparaten i måttliga klimat.
- 19) Den här apparaten får inte utsättas för dropp eller stänk och inga objekt, som har fyllts med vätskor såsom blomvaser, får placeras på apparaten.
- 20) Varning: Se alltid till att hela produkten placeras horisontellt på bordsytan för att undvika skador som orsakas av att den lutar.

* Den faktiska produkten kan variera i utseende från bilden ovan*

Om en strömsladd med kontakt används som frånkopplingsanordning indikerar installationsanvisningen att uttaget ska vara lättillgängligt.

	VAR FÖRSIKTIG RISK FÖR ELEKTRISK STÖT ÖPPNA INTE!	
VAR FÖRSIKTIG TA INTE BORT KÅPAN (ELLER BAKSIDAN) FÖR ATT REDUCERA RISKEN FÖR ELEKTRISK STÖT. INGA DELAR SOM KAN REPARERAS AV ANVÄNDAREN FINNS INUTI. ÖVERLÅT SERVICE TILL KVALIFICERAD SERVICEPERSONAL.		



Den här symbolen indikerar att det finns farlig spänning som utgör en risk för elektrisk stöt inuti enheten.



Den här symbolen indikerar att det finns viktiga drifts- och underhållsinstruktioner i litteraturen som levereras med den här enheten.

VARNING:

Utsätt inte apparaten för regn eller fukt för att reducera risken för elektrisk stöt.

VARNING:

Batterierna får inte utsättas för extrem värme såsom direkt solljus, öppen eld eller liknande.



Den här symbolen indikerar att den här produkten har en dubbel isolering mellan farlig nätspänning och användaråtkomliga delar. Använd endast identiska reservdelar vid service.



Den här märkningen indikerar att den här produkten inte ska kasseras med annat hushållsavfall. Materialresurserna ska återvinnas på ett ansvarsfullt sätt för att förhindra potentiella skador på miljön eller människors hälsa på grund av okontrollerad avfallshantering. Använd retur och upphämtningssystemen eller kontakta den återförsäljare där du köpte produkten. De kan se till att produkten återvinns på ett miljövänligt sätt.

VIKTIGA SÄKERHETSANVISNINGAR

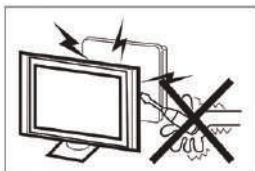

Den här TV-apparaten använder höga spänningar vid drift. Ta inte bort kåpan eller baksidan från apparaten. Överlåt service till kvalificerad servicepersonal.

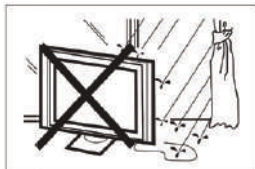

Utsätt inte TV-apparaten för regn eller fukt för att förhindra brand eller risk för elektrisk stöt.



Du får inte tappa apparaten eller tryck in föremål i TV-apparatens öppningar. Spill inte någon vätska på TV-apparaten.



Blockera inte ventilationshålerna på det bakre höljet. Tillräcklig ventilation är ett krav för att förhindra att elektriska komponenter skadas.



Kläm inte strömsladden under TV-apparaten.



Om TV-apparaten ska rengöras ska du koppla bort den, använda en mjuk trasa, inget vatten och aldrig kemikalier.

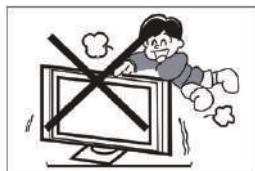

Du får aldrig stå på, luta dig mot eller plötsligt trycka på TV-apparaten eller dess stativ. Var särskilt uppmärksam på barn. Allvarlig personskada kan uppstå om apparaten faller.

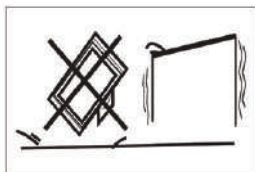

Placera inte den här TV-apparaten på en instabil vagn, stativ, hylla eller bord. Allvarliga personskador och skador på TV-apparaten kan uppstå om den faller.

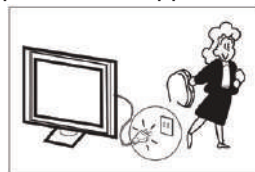

När TV-mottagaren inte används under en längre tidsperiod rekommenderas det att strömsladden kopplas bort från eluttaget.

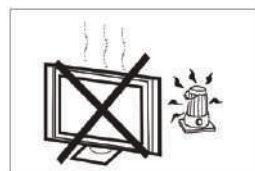

TV-apparaten får inte utsättas för direkt solljus eller andra värmekällor. Placera inte TV-apparaten direkt på andra produkter som avger värme såsom videokassettspelare eller förstärkare. Placera inte källor med öppen eld såsom tända ljus på TV-apparaten.

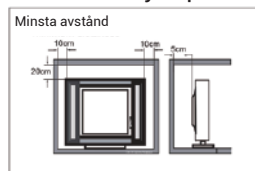

Om TV-apparaten ska placeras i ett fack eller liknande hölje måste de minsta avstånden respekteras. För hög värme kan reducera livslängden på TV-apparaten och kan även vara farlig.

Obs! användningen av apparaten i måttliga klimat. Varning:

En TV kan falla, orsaka allvarlig personskada eller dödsfall. Många personskador, i synnerhet hos barn, kan undvikas genom att vidta säkerhetsföreskrifter såsom att:

- ALLTID använda skåp, stativ och monteringsmetoder som rekommenderas av TV-apparatens tillverkare.
- ALLTID använd möbler som klarar TV-apparatens vikt.
- ALLTID se till att TV-apparaten inte hänger över kanten på möbelen den står på.
- ALLTID berättat för barn om riskerna med att klättra på möbler för att komma åt TV-apparaten eller dess funktioner.
- ALLTID förlägga de sladdar och kablar som är anslutna till TV-apparaten så att man inte snubblar på dem, eller att de går att greppa eller dra i.
- ALDRIG placera en TV-apparat på en instabil plats.
- ALDRIG placera TV-apparaten på höga möbler (exempelvis höga skåp eller bokhyllor) utan förankring av både möbelen och TV-apparaten i ett lämpligt stöd.
- ALDRIG placera TV-apparaten på dukar eller andra material som kan ligga mellan TV-apparaten och möbelen den står på.
- ALDRIG placera föremål såsom leksaker eller fjärrkontroller som kan locka barn att klättra på TV-apparaten eller möbelen den står på.

Om den befintliga TV-apparaten ska behållas och förflyttas bör samma överväganden som ovan tillämpas.

FÖRBEREDELSE

VIKTIGT: Utsätt inte skärmen för något tryck då detta kan äventyra dess integritet. Tillverkarens garanti täcker inte missbruk eller felaktiga installationer som utförs av användaren.

MONTERA STATIVET

VIKTIGT: TV-apparatens stativ måste monteras före användning.

1. Placera TV-apparaten med framsidan nedåt på en mjuk och plan yta (filt eller skum osv.) för att förhindra att den skadas.
2. Fäst stativet på undersidan av TV-apparaten med de 6 skruvarna.

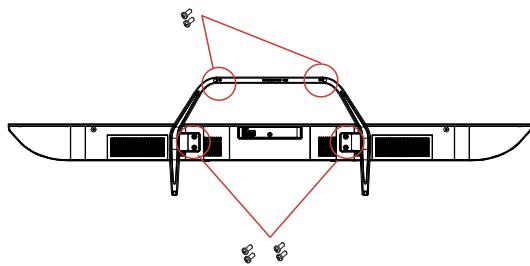

! OBS!
Produktens utseende ska vara såsom visas.

FÖRBEREDA LED-TV-APPARATEN FÖR VÄGGMONTERING

Vi föreslår att TV-apparaten monteras minst 60 mm (2,36 tum) från väggen för att ge utrymme för kablarna. Stativet måste tas bort innan TV-apparaten monteras på väggen.

För säkerhets skull ska du endast använda ett UL-listat väggfäste med TV-apparaten utan stativ som minsta vikt.

Så monterar du ett väggfäste på TV-apparaten:

1. Ta bort skruvarna som fäster TV-apparaten till stativet.
2. Ta bort stativet från TV-apparaten.
3. Montera väggfästet på baksidan av TV-apparaten med fyra skruvar. Följ instruktionerna i bruksanvisningen som medföljer väggfästet beträffande monteringen.

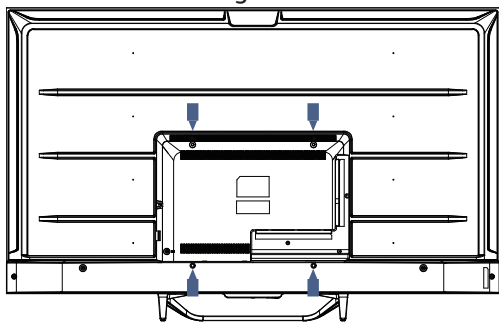

! OBS!
Väggfästet ingår inte.

4. Skruva fast skruvarna för väggmontering (M6 x 12 mm/4 st.) på baksidan av LED-TV-apparaten med ett vridmoment på 1,2 Nm.

SLÅ PÅ TV-APPARATEN

1. Montera stativet och placera TV-apparaten på en stadig yta.

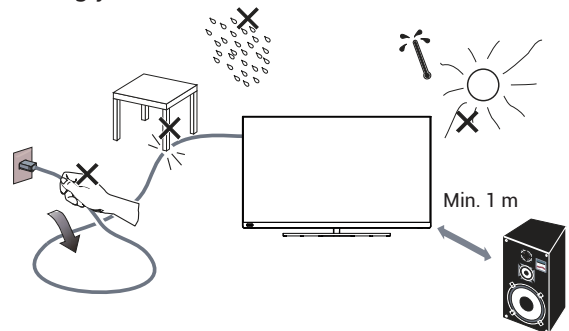

! OBS!

- Se till att TV-apparaten är placerad på ett sätt som låter luft strömma fritt runt den. Blockera inte ventilationshålen på det bakre höljet.
 - För att garantera säkerheten får inga källor med öppen eld, såsom tända ljus, placeras på eller i närheten av apparaten.
 - Undvik värme, direkt solljus och att apparaten utsätts för regn eller vatten. Apparaten får inte utsättas för dropp eller stänk.
2. Anslut antennkabeln eller kabel-TV-kabeln till antennuttaget **ANT IN** på baksidan av TV-apparaten.
 3. Fjärrkontroll:
Ta bort locket från batterifacket. Sätt i 2 st. batterier (Typ AAA 1,5 V).

VARNING: Risk för brand eller explosion om batterier byts ut mot en felaktig typ.

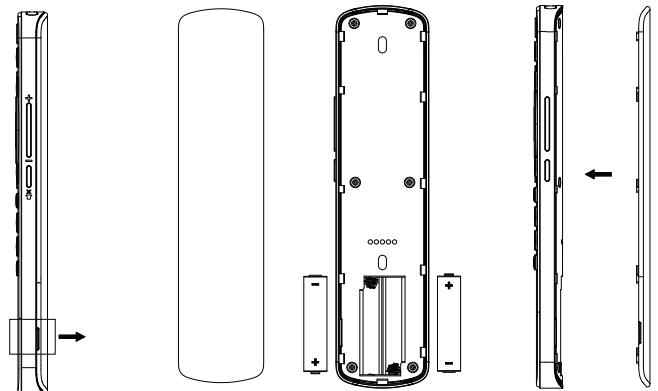

4. Ström:
Anslut strömsladden till ett eluttag som fungerar.

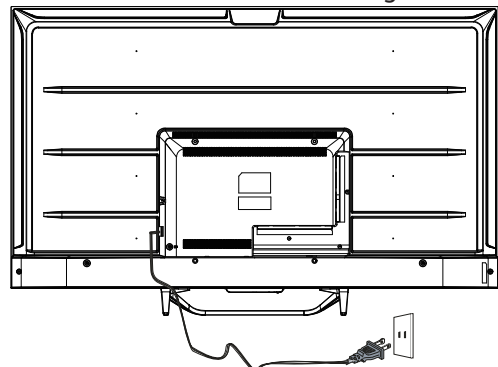

5. Slå på TV-apparaten:
Tryck på  på fjärrkontrollen eller **STRÖMBRYTAREN** på TV-apparatens kontrollpanel.

ANSLUTA KRINGUTRUSTNING OCH REGLAGE

KNAPPAR

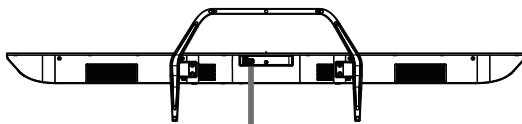
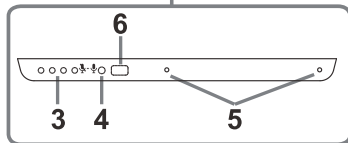
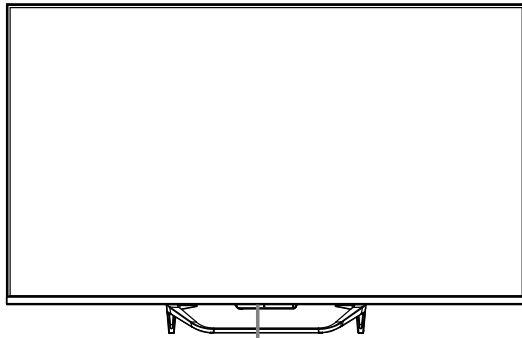

1 2

1. Ström på/Ström av
2. Röst på/Röst av
 - 🗨️ Aktivera Fjärrassistenten
 - 🗨️ Inaktivera Fjärrassistenten

Skjut reglaget åt höger för att aktivera funktionen. Indikatorn tänds och slocknar samt röstfunktionen initieras. Du kan säga "Ok Google" för att använda röstfunktionen. Indikatorn tänds när TV-apparaten detekterar rösten och du kan sedan säga det du vill direkt.

Skjut reglaget åt höger för att inaktivera röstfunktionen. Indikatorn lyser gult.

3. Indikator för Fjärrassistenten
4. Mottagare för fjärrkontrollsignal
5. Mottagare för röstsignaler
6. Ström-LED



OBS!

Se till att TV-apparaten är ansluten till internet innan du använder röstfunktionen.

Se till att röstfunktionen aktiveras innan den används.

Logga in på ett GOOGLE-konto innan röstfunktionen används.

TILLBEHÖR

- Fjärrkontroll – 1 st
- Bruksanvisning – 1 st
- Skrivar – 6 st
- Snabbstartsguide – 1 st
- Garantikort – 1 st

ANSLUTA KRINGUTRUSTNING



Terminalerna är som följer (från vänster till höger):
LAN, OPTISK, VIDEO, V, H, HDMI4, HDMI3, HDMI2,

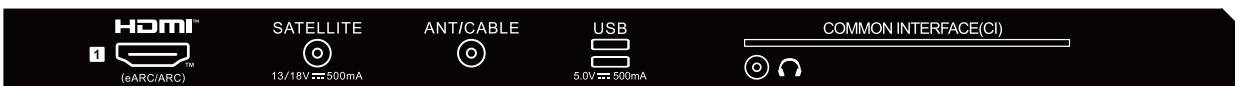

Terminalerna är som följer (från vänster till höger):
HDMI1 (eARC/ARC), LNB IN (SATELLIT), ANT IN (ANTENN/KABEL), USB1, USB2, HÖRLURAR, CI.

ANSLUTNINGAR

AV-UTRUSTNING

Den här TV-apparaten erbjuder en grupp med AV-uttag för att enkelt ansluta en video- eller DVD-spelare eller annan videoutrustning.

Se även bruksanvisningen för utrustningen som ska anslutas.

Uttagen på TV-apparatens baksida kan användas enligt följande.

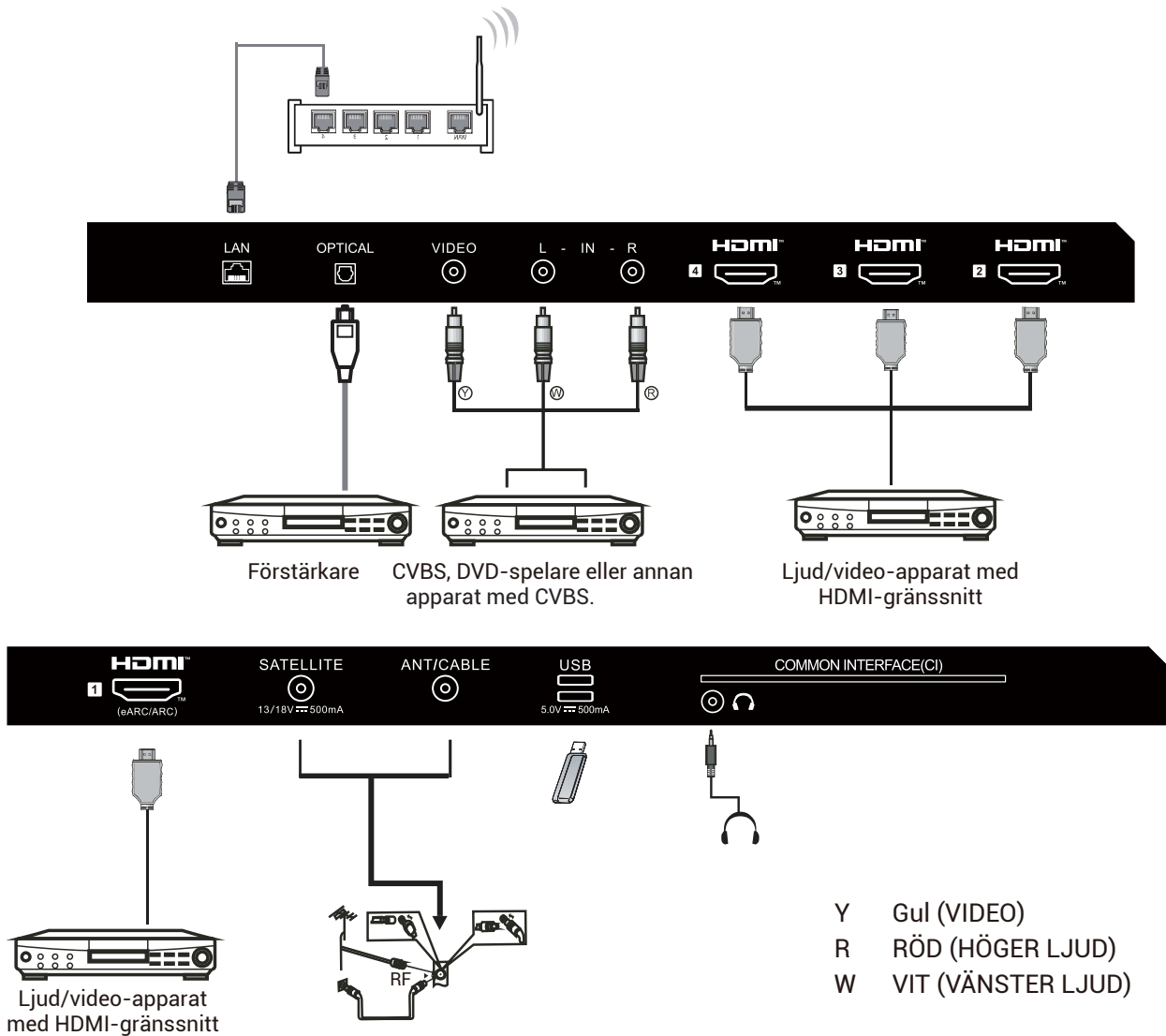

De kan användas med följande apparater: Videobandspelare, multiskivspelare, DVD-spelare, videokamera, spelkonsoler eller stereosystem osv ...

Obs!

Vissa enheter har inte stöd för den här funktionen då de levererar en icke standardiserad signal.

BRUKSANVISNINGAR

ANVÄNDA FJÄRRKONTROLLEN

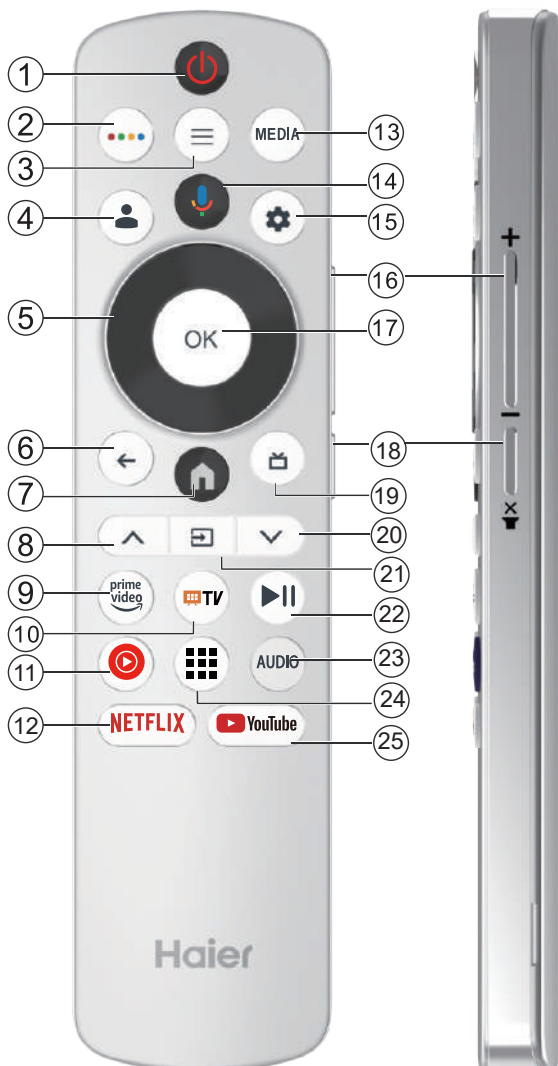

#	Artikel	Beskrivningar
1	Ström	Tryck för att slå på och stänga av TV-apparaten. När TV-apparaten är avstängd är den fortfarande strömförande. Koppla bort strömsladden för att helt koppla bort strömmen.
2		Tryck för att öppna MAGIC BOARD.
3		Tryck för att öppna eller stänga skärmmenyn.
4		Tryck för konton och för att logga in på Google TV. (När endast TV-apparaten konfigureras har den här knappen ingen effekt)
5		Tryck för att navigera skärmmenyn.
6		Återgå till föregående meny.
7		Tryck för att öppna startsidan.
8		Tryck för att byta TV-kanal.
9		Tryck för att öppna Prime video och titta på TV-program och filmer online (en internetanslutning krävs).
10		Tryck för att öppna Live TV.
11		Tryck för att öppna YouTube Music.
12		Tryck för att öppna NETFLIX.
13		Tryck för att öppna multimediaspelaren.
14		Tryck för att öppna Google Assistent eller starta en röstsökning.
15		Tryck för att öppna inställningsmenyn.
16	VOL+VOL-	Tryck på VOL+ or VOL- för att justera volymen.
17	OK	Ange det markerade alternativet eller utför den markerade åtgärden.
18		Tryck för att tysta eller aktivera ljudet.
19		Tryck för att visa en elektronisk programguide i TV-läget.
20		Tryck för att byta TV-kanal.
21		Tryck för att öppna listan över ingångskällor.
22		Tryck för att spela upp/pausa i multimedialäge.
23	AUDIO	Tryck för att byta ljudspår.
24		Tryck för att öppna appar.
25		Tryck för att öppna YouTube.

BRUKSANVISNINGAR

FÖRSTA KONFIGURATION

Första gången du slår på TV-apparaten leder inställningsguiden dig genom att konfigurera grundläggande inställningar.

Använd dig av tipsen för en första konfiguration.



Den här funktionen används för att parkoppla fjärrkontrollen. När parkopplingen är slutförd kan Bluetooth-fjärrkontrollen användas för att styra TV-apparaten.

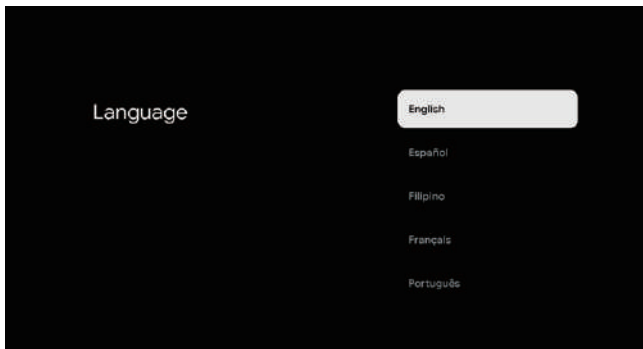

Tryck på ▲/▼ för att välja systemspråket och tryck sedan på OK för att bekräfta språket.

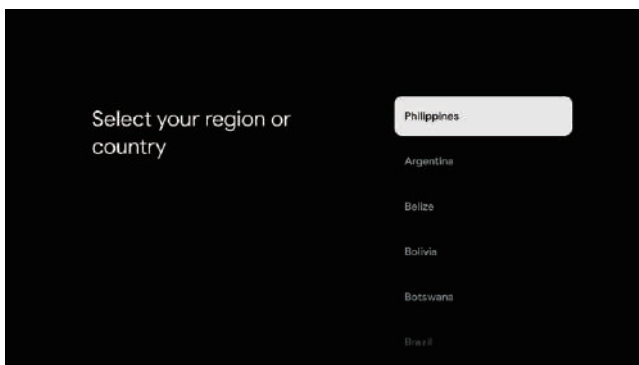

Tryck på ▲/▼ för att välja enhetens region/land och tryck sedan på OK för att bekräfta.

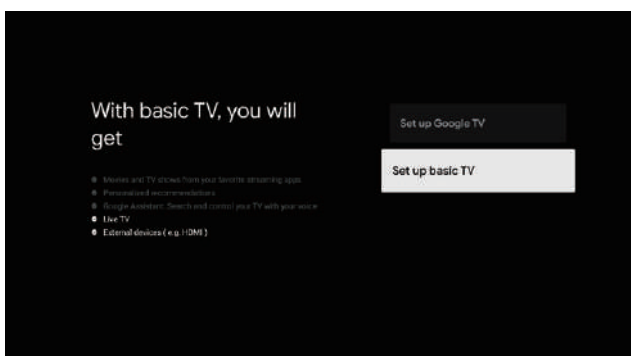

Tryck på ▲/▼ för att välja "Set up basic TV" (Konfigurera grundläggande TV-funktioner) på enheten och tryck sedan på OK för att slutföra konfigurationen.

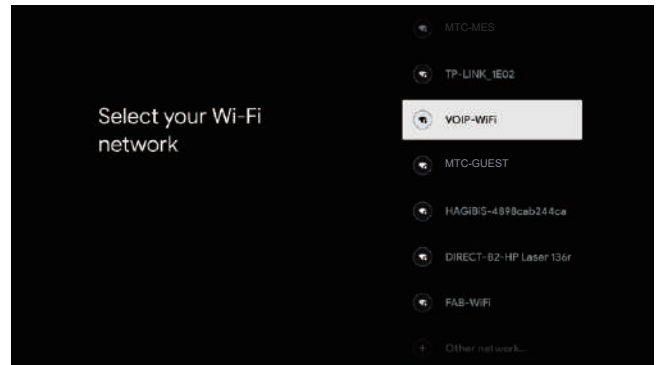

Tryck på ▲/▼ för att välja det Wi-Fi som ska anslutas till. Tryck sedan på OK och ange lösenordet för att bekräfta anslutningen.

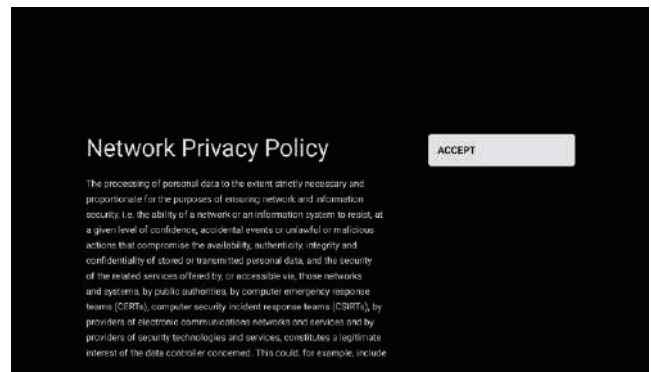

Välj "Accept" (Acceptera) för att acceptera villkoren i nätverkets integritetspolicy.

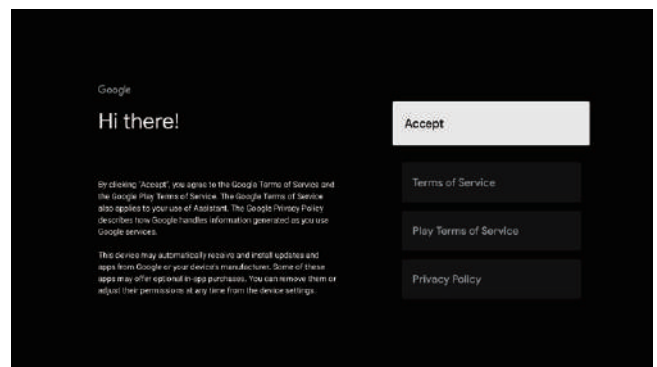

Du kan acceptera Googles användarvillkor för att förbättra produktupplevelsen. Välj "Accept" (Acceptera) för att godkänna dessa villkor.

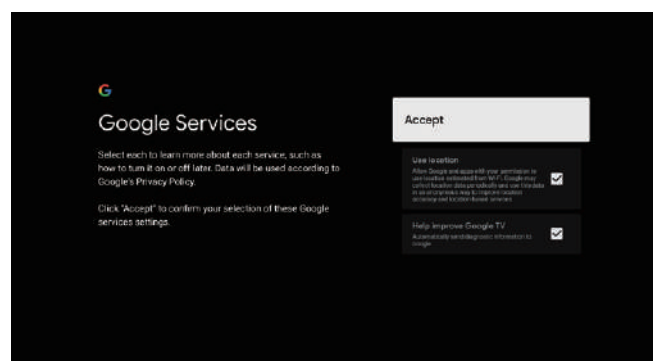

BRUKSANVISNINGAR

Du kan acceptera Googles tjänster för att förbättra produktupplevelsen. Välj "Accept" (Acceptera) för att godkänna dessa villkor.

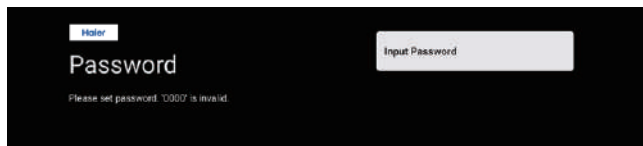

Används för att ange enhetens lösenord och garantera din säkerhet och integritet.

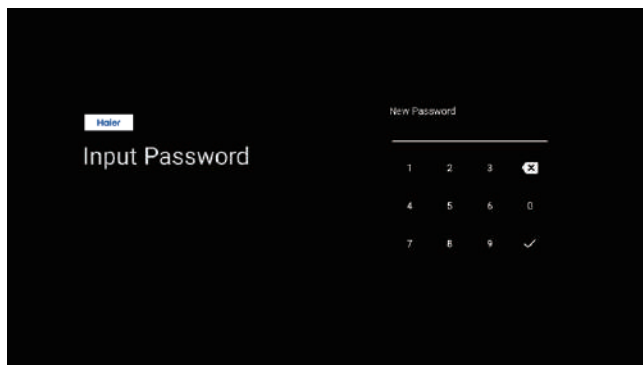

Använd fjärrkontrollen/skrämtangentbordet för att ange ett lösenord med 4 siffror och gå automatiskt till nästa gränssnitt.

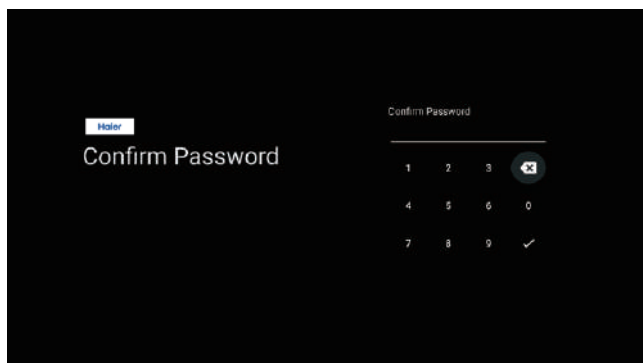

Använd fjärrkontrollen/skrämtangentbordet för att bekräfta med samma lösenord igen och slutföra konfigurationen.

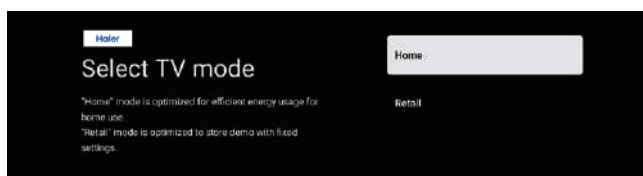

Tryck sedan på knapparna ▲/▼ för att välja läget Hem och tryck på OK.

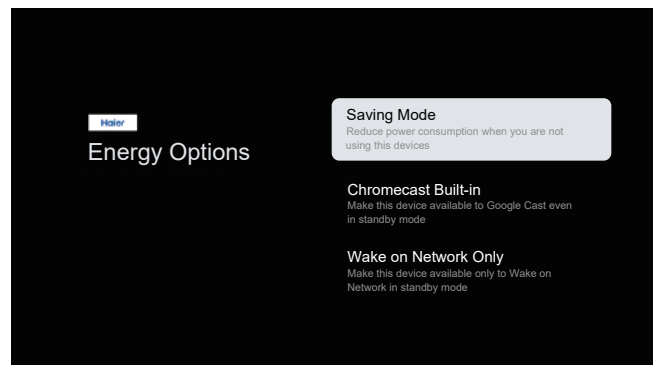

Välj "Saving Mode" (Energisparläge) och fortsätt till nästa steg.



Välj läget som ska användas för sökning och tryck på OK för att bekräfta.

BRUKSANVISNINGAR

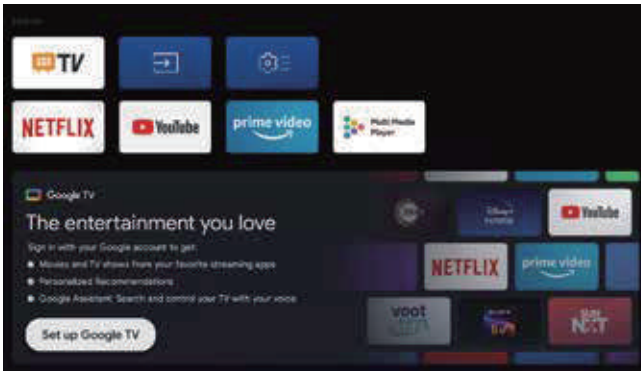

- När användargränssnittet öppnas kan du byta från grundläggande TV till Google TV-inställningar.

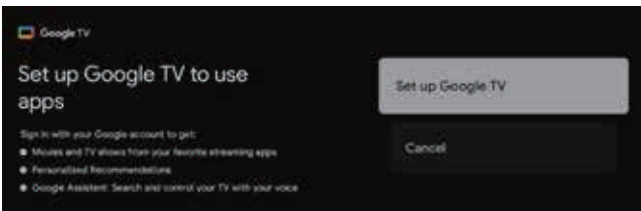

Tryck på ▲/▼ för att välja "Set up Google TV" (Konfigurera Google TV) på enheten och tryck sedan på OK för att slutföra konfigurationen.

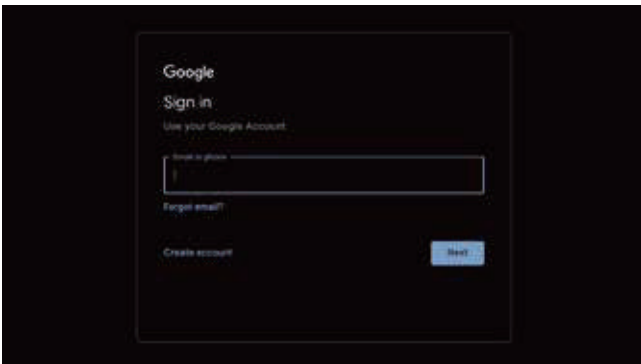

Använd ett Google-konto för att logga in

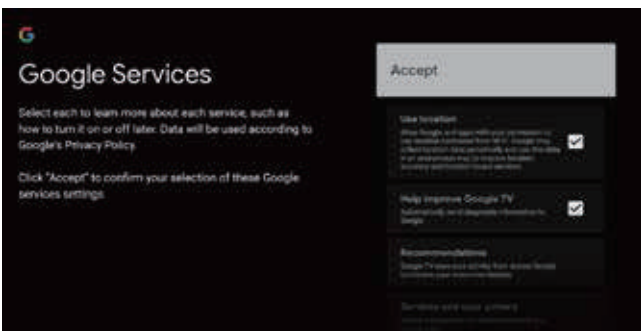
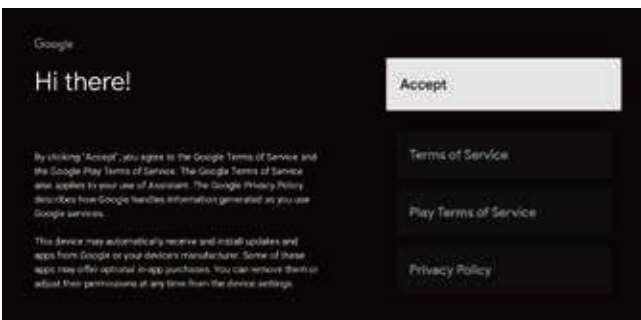

Du kan acceptera Googles användarvillkor för att förbättra produktupplevelsen. Välj "Accept" (Acceptera) för att godkänna dessa villkor.

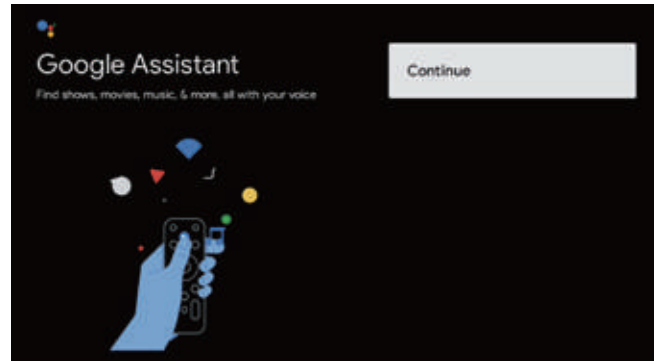

Använd fjärrkontrollen för att välja "Continue" (Fortsätt) och tryck på OK för att fortsätta.

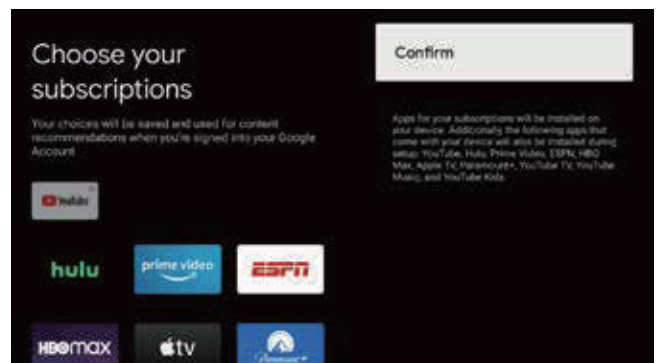

Tryck på ▲/▼ för att välja "Choose your subscriptions" (Välj dina prenumerationer) och tryck sedan på OK.

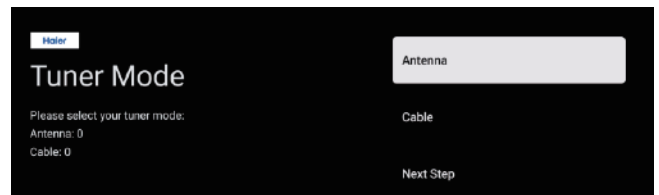

BRUKSANVISNINGAR

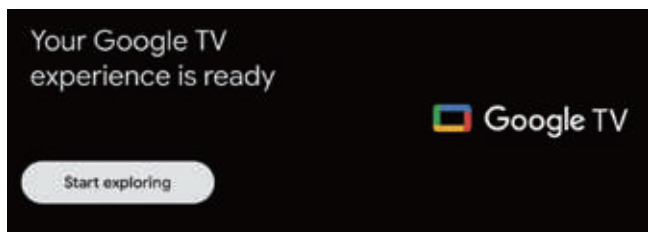

Din Google TV-upplevelse är redo. Tryck på OK för att börja utforska.

STARTSIDA

När inställningsguiden har slutförts kan du titta på TV och öppna startskärmen.

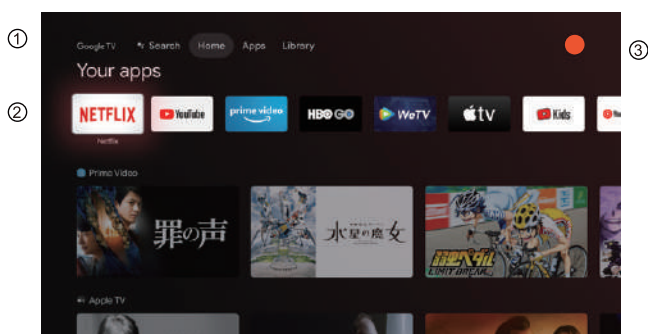

- ① **Search** Öppna Google Assistent eller starta en röstsökning.
Home Öppna TV-apparatens startskärm.
Apps Öppna listan över appar som finns installerade och lägg till dina favoritappar.
Library Se innehållet som har köpts och hyrts med användarkontot.
- ② En lista över appar som har installerats. Du kan även öppna dem och visa innehåll i installerade appar.
- ③ Öppna kontoinformation, inställningar, tid, ingångar och bilder.
Inställningar: Många olika inställningar kan konfigureras här. Se nästa förklaring för information om inställningarna.
Ingångar: Ikon för att välja en ingångskälla.
Bild: Användaren kan ställa in TV-bilden. Se sida 12 för detaljerade instruktioner om konfigurationen.

NAVIGERA PÅ SKÄRMMENYN

Det finns två sätt att öppna den. Det första alternativet är att med Live TV aktiverad trycka på menyknappen för att visa "TV options" (TV-alternativ). Tryck på ▲/▼/◀/▶ för att välja meny "Settings" (Inställningar) och tryck på OK för att bekräfta. Det andra alternativet är att öppna gränssnittet HOME och trycka på knappen ► för att välja ikonen för meny . Tryck sedan på OK för att bekräfta.

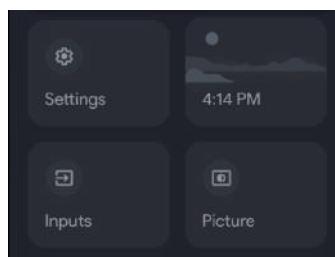
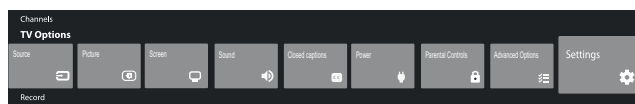

Tryck på knapparna ▲/▼ för att välja det som ska ställas in. Tryck på OK för ange inställningarna.

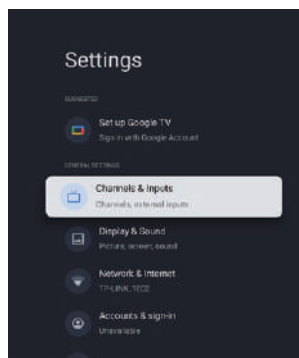

Tryck på "BACK" (TILLBAKA) för att återgå till föregående meny.
Tryck på "BACK" (TILLBAKA) för att stänga skärmmeny om huvudmenyn visas.

BRUKSANVISNINGAR

KANALER

Menu (Meny) -> Settings (Inställningar) -> Channels & Inputs (Kanaler och ingångar) -> Channels (Kanaler).

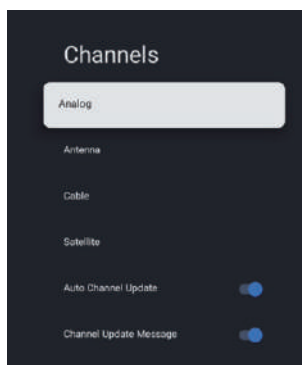

Analog/Antenna/Cable/Satellite (analog/antenn/kabel/satellit) – Tryck på knapparna ▲/▼ för att välja alternativ och tryck sedan på OK-knappen för att öppna undermenyn.

Auto Channel Update (automatisk kanaluppdatering) – Tryck på OK-knappen för att välja **ON/OFF (på/av)**. Om du väljer ON (på) kommer systemet automatiskt att söka efter och uppdatera kanaler efter fem minuters standby.

Channel Update Message (meddelande om kanaluppdatering) – Tryck på OK-knappen för att välja **ON/OFF (på/av)**. Om du väljer ON (på) visar systemet meddelandet om uppdatering.

Obs: Tillgänglig källa kan variera beroende på modell.

INGÅNGAR

Menu (Meny) -> Settings (Inställningar) -> Channels & Inputs (Kanaler och ingångar) -> Inputs (Ingångar).

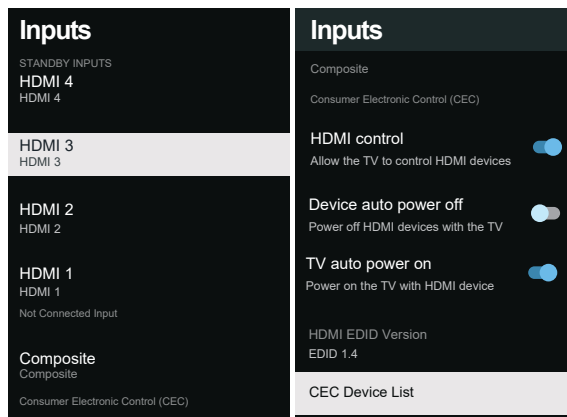

Inputs (Ingångar) – Tryck på knapparna ▲/▼ för att välja alternativet och tryck sedan på knappen OK för att öppna undermenyn.

HDMI control (HDMI-kontroll) – Tryck på knapparna ▲/▼ för att välja alternativet och tryck sedan på knappen OK för att välja PÅ/AV.

Device auto power off (Automatisk avstängning av enheten) – Tryck på knapparna ▲/▼ för att välja alternativet och tryck sedan på knappen OK för att välja PÅ/AV.

TV auto power on (Automatisk avstängning av TV-apparaten) – Tryck på knapparna ▲/▼ för att välja alternativet och tryck sedan på knappen OK för att välja PÅ/AV.

HDMI EDID Version (HDMI EDID-version) – visa EDID-versionen.

CEC Device List (CEC-enhetslista) – Tryck på knapparna ▲/▼ för att välja alternativet och tryck sedan på knappen OK för att öppna undermenyn.

BILD OCH LJUD

Menu (Meny) -> Settings (Inställningar) -> Display & Sound (Bild och ljud)

Den här menyn låter dig ställa in bild, ljud och ljudutgången för TV-apparaten.

1. Tryck på knapparna ▲/▼ för att välja det som ska ställas in.
2. Tryck på knappen OK för att
3. Tryck på knappen **BACK** (Tillbaka) för att återgå till föregående meny när du är klar med justeringen.

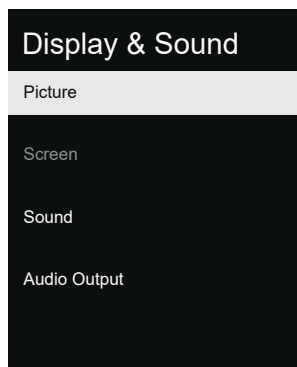

BRUKSANVISNINGAR

BILD

Menu (Meny) -> Settings (Inställningar) -> Display & Sound (Bild och ljud) -> Picture (Bild).

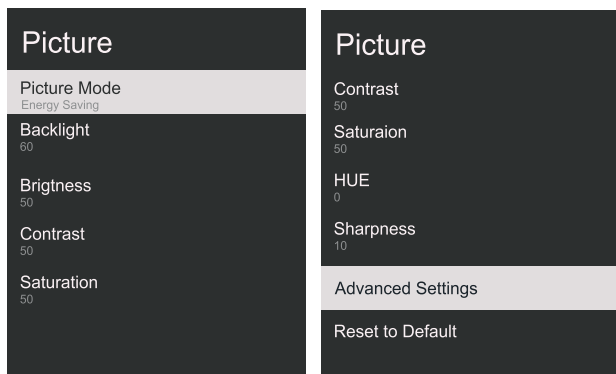

Picture Mode (Bildläge) – Tryck på knapparna ▲/▼ för att välja alternativet och öppna undermenyn. (Valmöjligheter: user (användare), Standard, Vivid (Livslik), Sport, Movie (Film), Game (Spel), Energy saving (Energibesparing)).

Backlight/Brightness/Contrast/Saturation/HUE/Sharpness (Bakgrundsbelysning, ljusstyrka/Kontrast/Mättnad/Nyans/Skärpa) – Tryck på knapparna ▲/▼ för att välja alternativet och tryck sedan på knappen **OK** för att öppna.

Tryck på ◀ för att minska parametern. Tryck på ▶ för att öka parametern.

Advanced Settings (Avancerade inställningar) – Tryck på knapparna ▲/▼ för att välja alternativet och tryck sedan på knappen **OK** för att öppna undermenyn.

Reset to Default (Återställ till standardvärden) – Återställ alla inställningar till fabriksinställningarna.

SOUND

Menu (Meny) -> Settings (Inställningar) -> Display & Sound (Bild och ljud) -> Sound (Ljud).

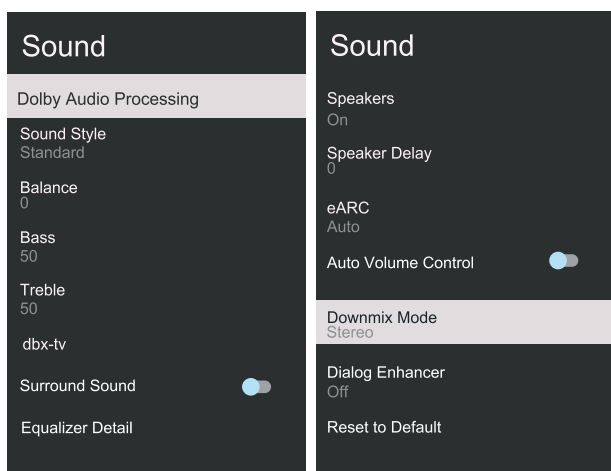

Dolby Audio processing (Dolby Audio-bearbetning) – Tryck på knapparna ▲/▼ för att välja alternativet och tryck sedan på knappen **OK** för att öppna undermenyn.

Sound style (Typ av ljud) – Tryck på knapparna ▲/▼ för att välja alternativet och tryck sedan på knappen

OK för att öppna undermenyn.

(Valmöjligheter: user (användare), Standard, Night (Natt), Sport, Movie (Film), Game (Spel), News (Nyheter)).

Balance/ Bass/Treble (Balans/Bas/Diskant) – Tryck på knapparna ▲/▼ för att välja alternativet och tryck sedan på knappen **OK** för att öppna.

Tryck på ◀ för att minska parametern.

Tryck på ▶ för att öka parametern.

dbx-tv – Tryck på knapparna ▲/▼ för att välja alternativet och tryck sedan på knappen **OK** för att öppna undermenyn.

Surround Sound (Surroundljud) – Tryck på knapparna ▲/▼ för att välja alternativet och tryck sedan på knappen **OK** för att välja PÅ/AV.

Equalizer Detail (Equalizer) – Tryck på knapparna ▲/▼ för att välja alternativet och tryck sedan på knappen **OK** för att öppna undermenyn.

Speakers (Högtalare) – Tryck på knapparna ▲/▼ för att välja alternativet och tryck sedan på knappen **OK** för att välja PÅ/AV.

Speaker Delay (Högtalarfördröjning) – Tryck på knapparna ▲/▼ för att välja alternativet och tryck sedan på knappen **OK** för att öppna.

Tryck på ◀ för att minska parametern. Tryck på ▶ för att öka parametern.

eARC – Tryck på knapparna ▲/▼ för att välja alternativet och tryck sedan på knappen **OK** för att välja Auto/AV.

Auto Volume Control (Automatisk volymkontroll) – Tryck på knapparna ▲/▼ för att välja alternativet och tryck sedan på knappen **OK** för att välja PÅ/AV.

Downmix Mode (Läget Nedmixning) – Tryck på knapparna ▲/▼ för att välja alternativet och tryck sedan på knappen **OK** för att öppna undermenyn. (Valmöjligheter: Stereo, Surround).

Dialog Enhancer (Dialogförstärkare) – Tryck på knapparna ▲/▼ för att välja alternativet och tryck sedan på knappen **OK** för att öppna undermenyn. (Valmöjligheter: Off (Av), Low (Låg), Medium (Medel) och High (Hög)).

Reset to Default (Återställ till standardvärden) – Återställ alla inställningar till fabriksinställningarna.

LJUDUTGÅNG

Menu (Meny) -> Settings (Inställningar) -> Display & Sound (Bild och ljud) -> Audio Output (Ljudutgång).

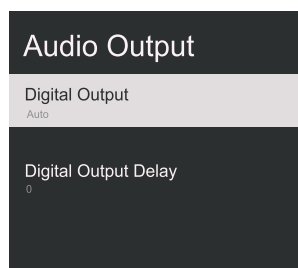

Digital Output (Digital utgång) – Tryck på knapparna ▲/▼ för att välja alternativet och tryck sedan på knappen **OK** för att öppna undermenyn.

BRUKSANVISNINGAR

(Valmöjligheter: Auto, Bypass (Förbikoppling), PCM, Dolby Digital Plus och Dolby Audio-Dolby Digital).
Digital Output Delay (Digital utgångsfördröjning) – Tryck på knapparna ▲/▼ för att välja alternativet och tryck sedan på knappen OK för att öppna. Tryck på ◀ för att minska parametern. Tryck på ▶ för att öka parametern.

NÄTVERK

Menu (Meny) -> Settings (Inställningar) -> Network & Internet (Nätverk och internet)

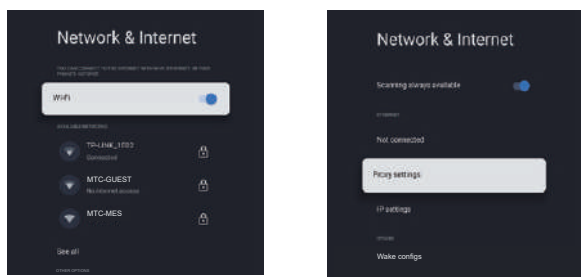

1. Tryck på knapparna ▲/▼ för att välja det som ska ställas in.
2. Tryck knappen OK för att bekräfta.
3. Tryck på knappen OK för att spara och återgå till föregående meny när du är klar med justeringen.

KONTON OCH INLOGGNING

1. Menu (Meny) -> Settings (Inställningar) -> Accounts & sign-in (Konton och inloggning).
2. Öppna gränssnittet HOME och tryck på knapparna ▲/▼ för att välja "Set up Google TV" (Konfigurera Google TV) och fortsätt till nästa steg.

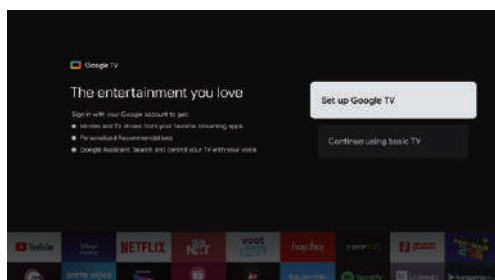

Välj "Set up Google TV" (Konfigurera Google TV) och fortsätt till nästa steg. Ange sedan login och lösenord.

Följ anvisningarna för att slutföra de relevanta inställningarna.

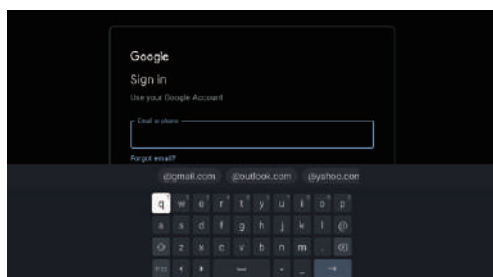

INTEGRITET

Menu (Meny) -> Settings (Inställningar) -> Privacy (Integritet).

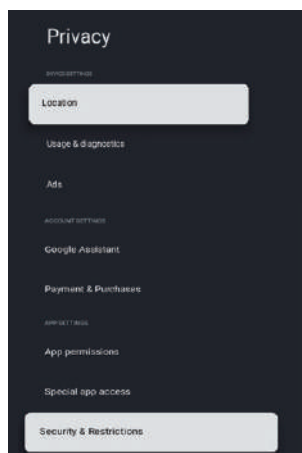

Den här menyn låter dig ställa in plats, användning och diagnostik osv. för TV-apparaten.

1. Tryck på knapparna ▲/▼ för att välja det som ska ställas in.
2. Tryck knappen OK för att bekräfta.
3. Tryck på knappen BACK (Tillbaka) för att återgå till föregående meny när du är klar med justeringen.

PLATS

Menu (Meny) -> Settings (Inställningar) -> Privacy (Integritet) -> Location (Plats).

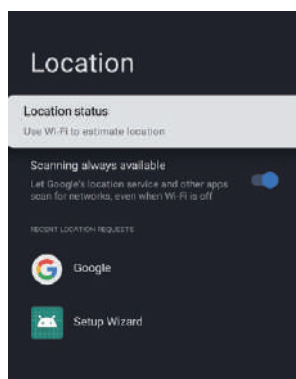

Location status (Platsstatus) – Tryck på knapparna ▲/▼ för att välja alternativet och tryck sedan på knappen OK för att öppna undermenyn. (Valmöjligheter: Use Wi-Fi to estimate location (Använd Wi-Fi för att uppskatta plats), Off (Av))

Scanning always available (Skanning alltid tillgänglig) – Tryck på knapparna ▲/▼ för att välja alternativet och tryck sedan på knappen OK för att välja PÅ/AV.

ANVÄNDNING OCH DIAGNOSTIK

Menu (Meny) -> Settings (Inställningar) -> Privacy (Integritet) -> Usage & diagnostics (Användning och diagnostik)

BRUKSANVISNINGAR

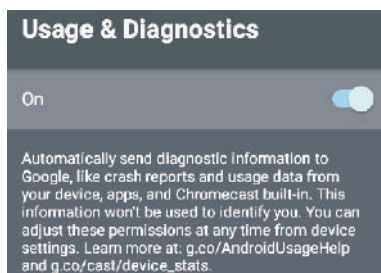

Usage & diagnostics (Användning och diagnostik)
– Tryck på knapparna ▲/▼ för att välja alternativet och tryck sedan på knappen OK för att välja PÅ/AV.

APPAR

Menu (Meny) -> Settings (Inställningar) -> Apps (Appar).

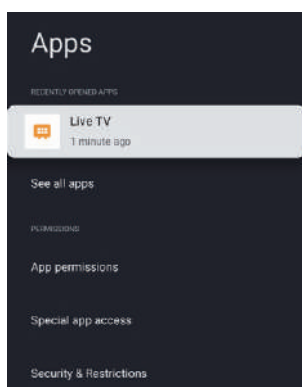

Den här menyn låter dig ställa in APP-behörigheterna och läsa listorna med appar

1. Tryck på knapparna ▲/▼ för att välja det som ska ställas in.
2. Tryck knappen OK för att bekräfta.
3. Tryck på knappen BACK (Tillbaka) för att återgå till föregående meny när du är klar med justeringen.

SYSTEM

Menu (Meny) -> Settings (Inställningar) -> System.

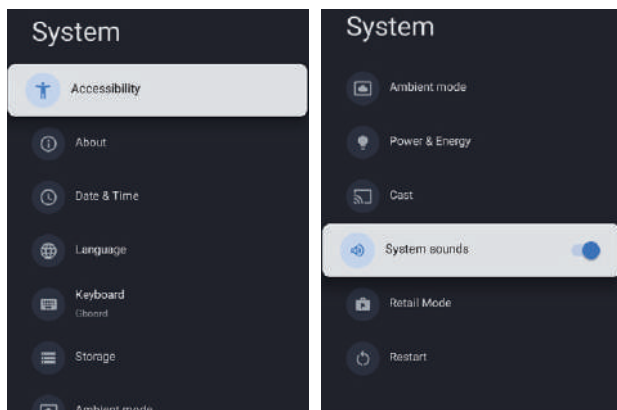

Den här menyn låter dig läsa information om TV-apparaten och dess inställningar.

1. Tryck på knapparna ▲/▼ för att välja det som ska ställas in.
2. Tryck knappen OK för att bekräfta.

3. Tryck på knappen BACK (Tillbaka) för att återgå till föregående meny när du är klar med justeringen.

System sounds (Systemljud) – Tryck på knapparna ▲/▼ för att välja alternativet och tryck sedan på knappen OK för att välja PÅ/AV.

Se nästa förklaring för information om systemet.

TILLGÄNGLIGHET

Menu (Meny) -> Settings (Inställningar) -> System -> Accessibility (Tillgänglighet).

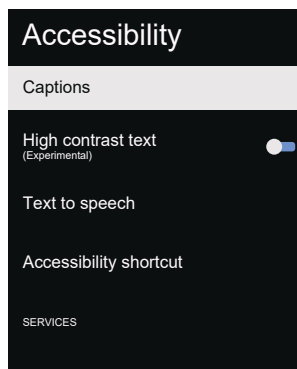

Captions (Bildtexter) – Tryck på knapparna ▲/▼ för att välja alternativet och tryck sedan på knappen OK för att öppna undermenyn.

High contrast text (Text med hög kontrast) – Tryck på knapparna ▲/▼ för att välja alternativet och tryck sedan på knappen OK för att välja PÅ/AV.

Text to speech (Text till tal) – Tryck på knapparna ▲/▼ för att välja alternativet och tryck sedan på knappen OK för att öppna undermenyn.

Accessibility shortcut (Genväg till Tillgänglighet) – Tryck på knapparna ▲/▼ för att välja alternativet och tryck sedan på knappen OK för att öppna undermenyn.

OM

Menu (Meny) -> Settings (Inställningar) -> System -> About (Om).

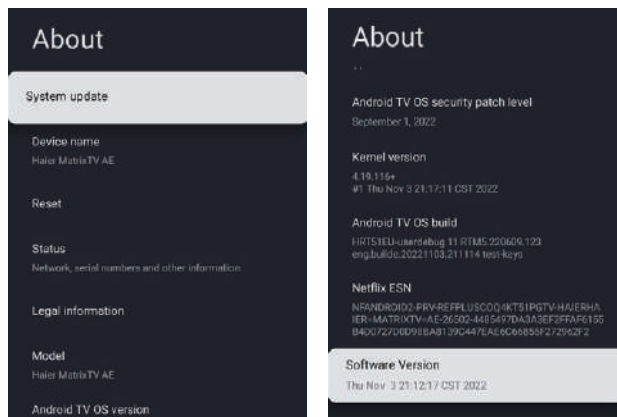

Den här menyn låter dig uppdatera och återställa systemet samt läsa informationen om TV-apparaten.

1. Tryck på knapparna ▲/▼ för att välja det som ska ställas in.

BRUKSANVISNINGAR

2. Tryck knappen **OK** för att bekräfta.
3. Tryck på knappen **BACK** (Tillbaka) för att återgå till föregående meny när du är klar med justeringen.

DATUM OCH TID

Menu (Meny) -> Settings (Inställningar) -> System -> Date & Time (Datum och tid).

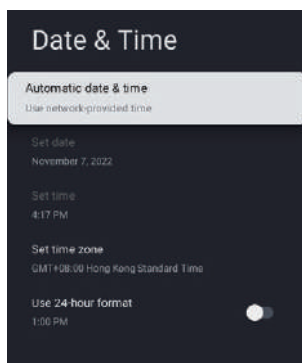

Automatic date & time (Automatiskt datum och tid)

– Tryck på knapparna ▲/▼ för att välja alternativet och tryck sedan på knappen **OK** för att öppna undermenyn.

(Valmöjligheter: Use network-provided time (Använd tid från nätverksleverantören), Off (Av))

OBS!

- När Automatic date & time (automatiskt datum och tid) ställs på OFF (av) går det att ställa in datum och tid manuellt.

Set date (Ställ in datum) – Tryck på knapparna ▲/▼ för att välja alternativet och tryck sedan på knappen **OK** för att öppna undermenyn.

Set time (Ställ in tid) – Tryck på knapparna ▲/▼ för att välja alternativet och tryck sedan på knappen **OK** för att öppna undermenyn.

Set time zone (Ställ in tidszon) – Tryck på knapparna ▲/▼ för att välja alternativet och tryck sedan på knappen **OK** för att öppna undermenyn.

Use 24-hour format (Använd 24-timmarsformat) – Tryck på knapparna ▲/▼ för att välja alternativet och tryck sedan på knappen **OK** för att välja PÅ/AV.

SPRÅK

Menu (Meny) -> Settings (Inställningar) -> System -> Language (Språk).

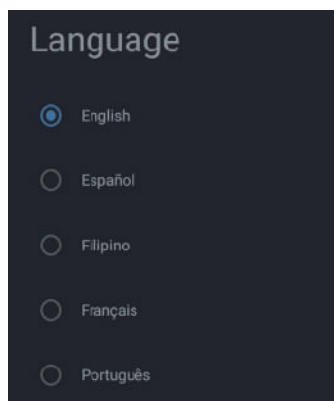

Language (Språk) – Tryck på knapparna ▲/▼ för att välja alternativet och tryck sedan på knappen **OK** för att ange det markerade språket.

TANGENTBORD

Menu (Meny) -> Settings (Inställningar) -> System -> Keyboard (Tangentbord).

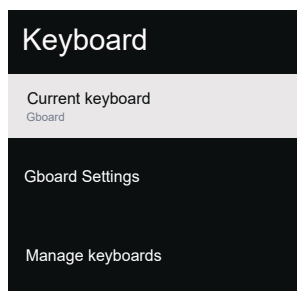

Current keyboard (Nuvarande tangentbord) – Tryck på knapparna ▲/▼ för att välja alternativet och tryck sedan på knappen **OK** för att öppna undermenyn.

Gboard Settings (Gboard-inställningar) – Tryck på knapparna ▲/▼ för att välja alternativet och tryck sedan på knappen **OK** för att öppna undermenyn.

Manage keyboards (Hantera tangentbord) – Tryck på knapparna ▲/▼ för att välja alternativet och tryck sedan på knappen **OK** för att öppna undermenyn.

LAGRING

Menu (Meny) -> Settings (Inställningar) -> System -> Storage (Lagring).

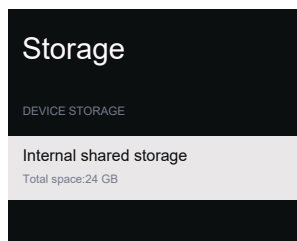

Internal shared storage (Intern delad lagring) – Tryck på knapparna ▲/▼ för att välja alternativet och tryck sedan på knappen **OK** för att öppna undermenyn.

OMGIVANDE LÄGE

Menu (Meny) -> Settings (Inställningar) -> System -> Ambient mode (Omgivande läge).

BRUKSANVISNINGAR

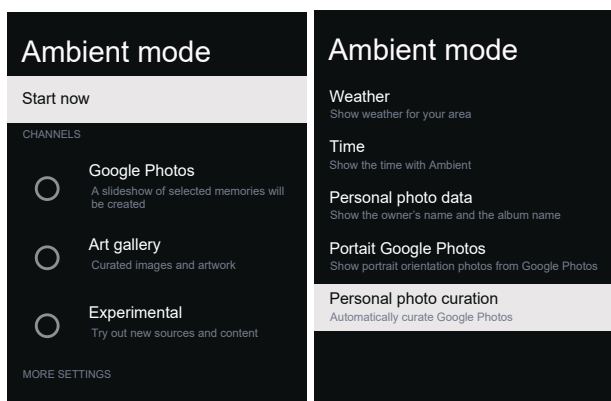

Den här menyn låter dig ställa in det omgivande läget.

1. Tryck på knapparna ▲/▼ för att välja det som ska ställas in.
2. Tryck knappen **OK** för att bekräfta.
3. Tryck på knappen **BACK** (Tillbaka) för att återgå till föregående meny när du är klar med justeringen.

STRÖM OCH ENERGI

Menu (Meny) -> Settings (Inställningar) -> System -> Power & Energy (Ström och energi).

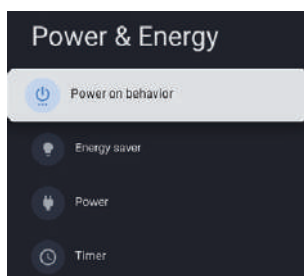

Den här menyn låter dig ställa in ström och energi. (power on behavior (funktion vid uppstart), energy saver (energibesparing), power and timer (ström och timer))

1. Tryck på knapparna ▲/▼ för att välja det som ska ställas in.
2. Tryck knappen **OK** för att bekräfta.
3. Tryck på knappen **BACK** (Tillbaka) för att återgå till föregående meny när du är klar med justeringen.

FUNKTION VID UPPSTART

Menu (Meny) -> Settings (Inställningar) -> System -> Power & Energy (Ström och energi) -> Power on behavior (Funktion vid uppstart).

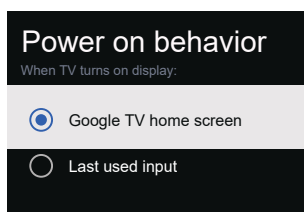

Tryck på knapparna ▲/▼ för att välja alternativet och tryck sedan på knappen **OK** för att bekräfta.

ENERGIBESPARING

Menu (Meny) -> Settings (Inställningar) -> System -> Power & -> Energy (Ström och energi) -> Energy saver (Energibesparing).

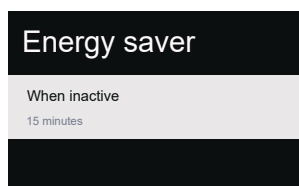

When inactive (Vid inaktivitet) – Tryck på knapparna ▲/▼ för att välja alternativet och tryck sedan på knappen **OK** för att öppna undermenyn.

(Valmöjligheter: 15 minutes (minuter), 20 minutes (minuter), 30 minutes (minuter), 1 hour (timme), 4 hours (timmar), 8 hours (timmar), 12 hours (timmar), 24 hours (timmar), Never (Aldrig)).

STRÖM

Menu (Meny) -> Settings (Inställningar) -> System -> Power & Energy (Ström och energi) -> Power (Ström).

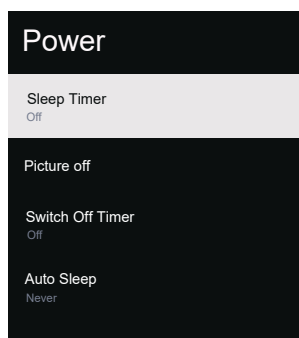

Sleep Timer (Insomningstimer) – Tryck på knapparna ▲/▼ för att välja alternativet och tryck sedan på knappen **OK** för att öppna undermenyn. (Valmöjligheter: off (av), 10 minutes (minuter), 20 minutes (minuter), 30 minutes (minuter), 40 minutes (minuter), 50 minutes (minuter), 60 minutes (minuter), 90 minutes (minuter), 120 minutes (minuter))

Picture off (Bild av) – Tryck på knapparna ▲/▼ för att välja alternativet och tryck sedan på knappen **OK** för att bekräfta.

Switch off timer (Stäng av timern) – Tryck på knapparna ▲/▼ för att välja alternativet och tryck sedan på knappen **OK** för att öppna undermenyn. (Valmöjligheter: off (av), 30 minutes (minuter), 60 minutes (minuter), 90 minutes (minuter), 120 minutes (minuter), 150 minutes (minuter), 180 minutes (minuter), 210 minutes (minuter), 240 minutes (minuter))

Auto Sleep (Automatisk insomning) – Tryck på knapparna ▲/▼ för att välja alternativet och tryck sedan på knappen **OK** för att öppna undermenyn. (Valmöjligheter: Never (Aldrig), 4 hours (timmar), 6 hours (timmar), 8 hours (timmar))

BRUKSANVISNINGAR

TIMER

Menu (Meny) -> Settings (Inställningar) -> System -> Power & Energy (Ström och energi) -> Timer.

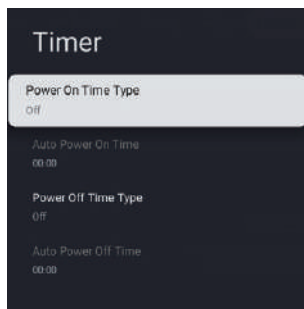

Power On Time Type (Typ av timer för påslagning)

– Tryck på knapparna ▲/▼ för att välja alternativet och tryck sedan på knappen **OK** för att välja OFF (AV)/ON (PÅ)/ONCE (EN GÅNG).

Auto Power On Time (Automatisk tid för påslagning)

– Tryck på knapparna ▲/▼ för att välja alternativet och tryck sedan på knappen **OK** för att öppna undermenyn.

Power Off Time Type (Typ av timer för avstängning)

– Tryck på knapparna ▲/▼ för att välja alternativet och tryck sedan på knappen **OK** för att välja OFF (AV)/ON (PÅ)/ONCE (EN GÅNG).

Auto Power On Time (Automatisk tid för avstängning) – Tryck på knapparna ▲/▼ för att välja alternativet och tryck sedan på knappen **OK** för att öppna undermenyn.

CASTA

Menu (Meny) -> Settings (Inställningar) -> System -> Cast (Casta).

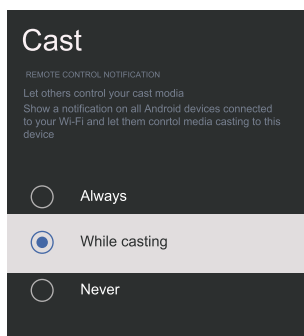

1. Tryck på knapparna ▲/▼ för att välja det som ska ställas in.
2. Tryck knappen **OK** för att bekräfta.
3. Tryck på knappen "BACK" (TILLBAKA) för att återgå till föregående meny.

BUTIKSLÄGE

Menu (Meny) -> Settings (Inställningar) -> System -> Retail Mode (Butiksläge).

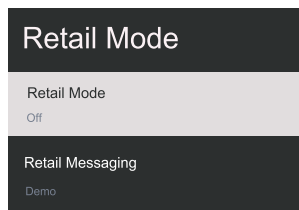

Retail mode (Butiksläge) – Tryck på knapparna ▲/▼ för att välja alternativet och tryck sedan på knappen **OK** för att välja PÅ/AV.

Retail messaging (Butiksmeddelanden) – Tryck på knapparna ▲/▼ för att välja alternativet och tryck sedan på knappen **OK** för att öppna undermenyn. (Obs! Demo, e-POP, e-POP + Demo (e-POP + demo))

OMSTART

Menu (Meny) -> Settings (Inställningar) -> System -> Restart (Omstart).

Tryck på knappen **OK** för att öppna undermenyn. (Valmöjligheter: starta om och avbryt)

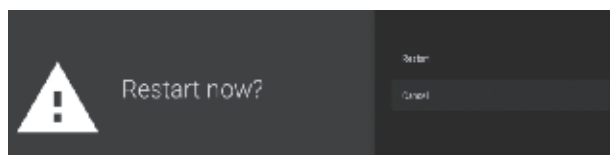

FJÄRRKONTROLLER OCH TILLBEHÖR

Menu (Meny) -> Settings (Inställningar) -> Remotes & Accessories (Fjärrkontroller och tillbehör).

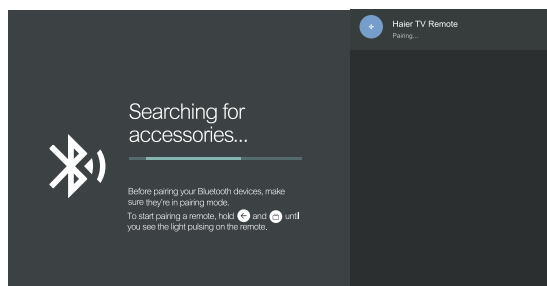
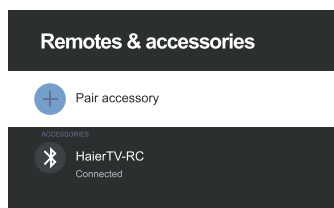

Den här menyn låter dig parkoppla med Bluetooth-enheter.

1. Tryck på knapparna "←" och "⏏" längst ned på fjärrkontrollen och håll dem nedtryckta i 5 sekunder.

BRUKSANVISNINGAR

2. Släpp upp dem när LED-indikatorn börjar blinka. Fjärrkontrollen skickar parkopplingssignalen till TV-apparaten som visar informationen om fjärrkontrollen på höger sida av skärmen.
3. Tryck på knappen **OK** för att visa parkopplingen. Anslutningen slutförs när parkopplingen visas.
4. Anslutningen slutförs inte om parkopplingen inte visas. Vänta 30 sekunder och tryck sedan på knapparna "←" och "⏪" längst ner på fjärrkontrollen, och håll dem nedtryckta i 5 sekunder, för att upprepa de föregående stegen.
5. Tryck på knappen "←" för att återgå till föregående meny.

ANVÄNDA MULTIMEDIASPELAREN

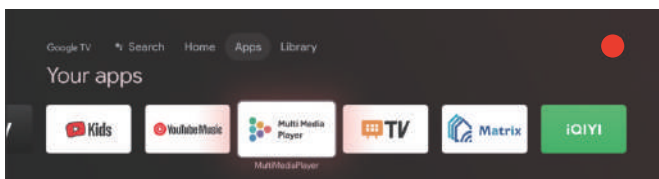

1. Öppna gränssnittet HOME (Hem) eller **APPS** (APPAR) och **tryck** sedan på ▲/▼/◀/▶ **för att** välja appen Multimediaspelaren

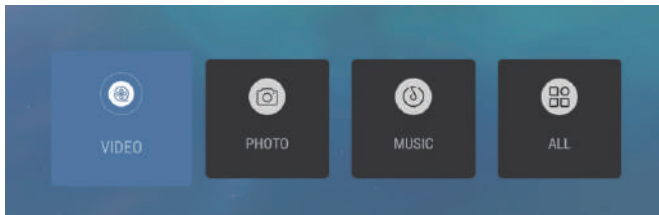

2. Välj knappen OK för att öppna multimediaspelaren och visa video och foton samt spela upp ljud. När USB-minnet har anslutit visas motsvarande filer på USB-minnet (FAT32-format).

OBS!

Menyn kan variera beroende på när TV-apparaten köptes.

FELSÖKNING

Utför följande enkla kontroller innan du kontaktar kundservice. Dessa tips kan spara tid och pengar då avgifter för installation av apparaten och justeringar av kundinställningar inte täcks av garantin.

Symptom	Saker att kontrollera och åtgärder att utföra
"Spökbild" eller dubbel bild	<ul style="list-style-type: none">• Detta kan bero på att antennen störs av hinder såsom höga byggnader eller berg. Med hjälp av en effektiv och riktad antenn kan bildkvaliteten förbättras.
Ingen ström	<ul style="list-style-type: none">• Kontrollera om TV-apparatens strömsladd är ansluten till eluttaget.• Koppla bort TV-apparaten och vänta 60 sekunder. Anslut sedan stickkontakten till eluttaget och slå på TV-apparaten.
Ingen bild	<ul style="list-style-type: none">• Kontrollera antennens anslutning på baksidan av TV-apparaten för att kontrollera om den är korrekt ansluten.• Möjligt problem med stationens signal. Prova med en annan kanal.• Justera inställningarna för kontrast och ljusstyrka.• Kontrollera inställningarna för bildtext. Vissa TEXT-lägen kan blockera skärmen.
Bra bild men inget ljud	<ul style="list-style-type: none">• Tryck på knappen MUTE (Tysta) på fjärrkontrollen för att aktivera ljudet.
Bra ljud men dåliga färger	<ul style="list-style-type: none">• Justera inställningarna för kontrast, färg och ljusstyrka.
Dålig bildkvalitet	<ul style="list-style-type: none">• Dålig bildkvalitet kan uppstå när en S-VHS-kamera eller videokamera är ansluten till TV-apparaten samtidigt som annan kringutrustning. Stäng av annan kringutrustning.
Brusig bild	<ul style="list-style-type: none">• Kontrollera antennens anslutning.
Horisontell prickad linje	<ul style="list-style-type: none">• Detta kan orsakas av elektriska störningar (såsom en hårtork, närliggande neonljus osv.). Stäng av utrustningen som orsakar problemet.
TV-apparaten svarar inte på fjärrkontrollen	<ul style="list-style-type: none">• Kontrollera om batterierna fungerar. Byt ut efter behov.• Rengör fjärrkontrollens sensorlins på TV-apparaten.
Pixlar (prickar) som alltid är mörka eller upplysta	<ul style="list-style-type: none">• TV-apparaten är en precisionstillverkad utrustning med extremt hög teknisk komplexitet. Det kan dock hända att vissa pixlar inte visas korrekt. Dessa typer av förekomster är en del av den här typen av produkter och utgör inte en defekt produkt.

OBS!

- Den här produkten använder en panel som består av subpixlar som kräver sofistikerad teknik för att producera. Dock kan några ljusa eller mörka pixlar uppstå på skärmen. Dessa pixlar påverka inte produktens prestanda.



Termerna HDMI, HDMI High-Definition Multimedia Interface, HDMI Trade Dress och HDMI-logotyperna är varumärken eller registrerade varumärken som tillhör HDMI Licensing Administrator, Inc.



Dolby, Dolby Vision, Dolby Atmos, Dolby Audio och symbolen dubbelt D är varumärken som tillhör Dolby Laboratories Licensing Corporation. Tillverkas under licens från Dolby Laboratories. Konfidentiellt opublicerat verk. Copyright ©2012-2024 Dolby Laboratories. Alla rättigheter reserverade.

PRODUKTSPECIFIKATIONER

43 tum UHD LED-TV

TV-apparatens bildkvalitet:	UHD Integrerad digital. Skärmens storlek: 108 cm Upplösning: 3840 x 2160 pixlar vid 60 Hz.
TV-systemet:	PAL-B/G, SECAM-B/G
DTV-avkodare	DVB-T, DVB-C, DVB-T2, DVB-S2 16/32/64/128/256 QAM-modulering MPEG2, MPEG4, H.265
Anslutningar:	1 optisk port 2 USB-portar 1 LAN 4 HDMI-uttag 1 VIDEO-uttag 1 L-uttag 1 R-uttag 2 RF-uttag 1 port för HÖRLURAR 1 CI-plats System som stöds: PAL+SECAM Antal kanaler som kan lagras: 1000 (DTV), 100 (ATV) TV (RF) :75 Ω impedans AV Video-ingång: 75 Ω, 1 V-P, RCA AV Audio-ingång: 20 KΩ, 500 mV RMS HDMI Video-ingång: 480i, 480p, 720p, 1080i, 1080p, 2160p Wi-Fi: Standard: IEEE 802.11a/b/g/n/ac, Frekvens: 2,4/5 GHz Bluetooth: V5.1
Ljudkvalitet:	Stereoljudsystem. 2 x 10 W RMS-uteffekt.
Strömförbrukning i standby	≤ 0,5 W
Digitala funktioner:	Digital interaktivitet. Digital text. Digital video broadcasting (DVB) -undertexter tillgängliga. Automatisk konfiguration. Automatisk sökning efter nya kanaler. Programguide med nuvarande och nästa program. Elektronisk programguide för 7 dagar (EPG). CI-plats. Kompatibel med ljudbeskrivning.
Ytterligare funktioner:	UHF/VHF-tuner, insomningstimer, föräldrahandledning, bild och text Fjärrkontrollen kräver 2 x AAA-batterier. Storlek på VESA-fäste: 300 x 300 mm Förpackningens storlek (B x H x D): 1075 x 652 x 142 mm Apparatens storlek (B x H x D) med stativ: 957,2 x 607,4 x 240,7 mm Apparatens storlek (B x H x D) utan stativ: 957,2 x 566,7 x 86,6 mm Förpackningens vikt: 10 kg Apparatens vikt med stativ: 7,2 kg Apparatens vikt utan stativ: 6,8 kg

* Delarnas specifikationer för den här TV-apparaten tillhandahålls endast för referens.
Skillnader kan uppstå allt eftersom produktens teknik utvecklas.
Design och specifikationer kan ändras utan föregående meddelande.

PRODUKTSPECIFIKATIONER

50 tum UHD LED-TV

TV-apparatens bildkvalitet:	UHD Integrerad digital. Skärmens storlek: 126 cm Upplösning: 3840 x 2160 pixlar vid 60 Hz.
TV-systemet:	PAL-B/G, SECAM-B/G
DTV-avkodare	DVB-T, DVB-C, DVB-T2, DVB-S2 16/32/64/128/256 QAM-modulering MPEG2, MPEG4, H.265
Anslutningar:	1 optisk port 2 USB-portar 1 LAN 4 HDMI-uttag 1 VIDEO-uttag 1 L-uttag 1 R-uttag 2 RF-uttag 1 port för HÖRLURAR 1 CI-plats System som stöds: PAL+SECAM Antal kanaler som kan lagras: 1000 (DTV), 100 (ATV) TV (RF) :75 Ω impedans AV Video-ingång: 75 Ω, 1 V-P, RCA AV Audio-ingång: 20 KΩ, 500 mV RMS HDMI Video-ingång: 480i, 480p, 720p, 1080i, 1080p, 2160p Wi-Fi: Standard: IEEE 802.11a/b/g/n/ac, Frekvens: 2,4/5 GHz Bluetooth: V5.1
Ljudkvalitet:	Stereoljudsystem. 2 x 13.5 W RMS-ut effekt.
Strömförbrukning i standby	≤ 0,5 W
Digitala funktioner:	Digital interaktivitet. Digital text. Digital video broadcasting (DVB) -undertexter tillgängliga. Automatisk konfiguration. Automatisk sökning efter nya kanaler. Programguide med nuvarande och nästa program. Elektronisk programguide för 7 dagar (EPG). CI-plats. Kompatibel med ljudbeskrivning.
Ytterligare funktioner:	UHF/VHF-tuner, insomningstimer, föräldrahandledning, bild och text Fjärrkontrollen kräver 2 x AAA-batterier. Storlek på VESA-fäste: 300 x 300 mm Förpackningens storlek (B x H x D): 1250 x 760 x 144 mm Apparatens storlek (B x H x D) med stativ: 1111,2 x 710,5 x 277,2 mm Apparatens storlek (B x H x D) utan stativ: 1111,2 x 651,8 x 88 mm Förpackningens vikt: 13,5 kg Apparatens vikt med stativ: 10 kg Apparatens vikt utan stativ: 9,5 kg

* Delarnas specifikationer för den här TV-apparaten tillhandahålls endast för referens.
Skillnader kan uppstå allt eftersom produktens teknik utvecklas.
Design och specifikationer kan ändras utan föregående meddelande.

PRODUKTSPECIFIKATIONER

55 tum UHD LED-TV

TV-apparatens bildkvalitet:	UHD Integrerad digital. Skärmens storlek: 139 cm Upplösning: 3840 x 2160 pixlar vid 60 Hz.
TV-systemet:	PAL-B/G, SECAM-B/G
DTV-avkodare	DVB-T, DVB-C, DVB-T2, DVB-S2 16/32/64/128/256 QAM-modulering MPEG2, MPEG4, H.265
Anslutningar:	1 optisk port 2 USB-portar 1 LAN 4 HDMI-uttag 1 VIDEO-uttag 1 L-uttag 1 R-uttag 2 RF-uttag 1 port för HÖRLURAR 1 CI-plats System som stöds: PAL+SECAM Antal kanaler som kan lagras: 1000 (DTV), 100 (ATV) TV (RF) :75 Ω impedans AV Video-ingång: 75 Ω, 1 V-P, RCA AV Audio-ingång: 20 KΩ, 500 mV RMS HDMI Video-ingång: 480i, 480p, 720p, 1080i, 1080p, 2160p Wi-Fi: Standard: IEEE 802.11a/b/g/n/ac, Frekvens: 2,4/5 GHz Bluetooth: V5.1
Ljudkvalitet:	Stereoljudsystem. 2 x 13,5 W RMS-ut effekt.
Strömförbrukning i standby	≤ 0,5 W
Digitala funktioner:	Digital interaktivitet. Digital text. Digital video broadcasting (DVB) -undertexter tillgängliga. Automatisk konfiguration. Automatisk sökning efter nya kanaler. Programguide med nuvarande och nästa program. Elektronisk programguide för 7 dagar (EPG). CI-plats. Kompatibel med ljudbeskrivning.
Ytterligare funktioner:	UHF/VHF-tuner, insomningstimer, föräldrahandledning, bild och text Fjärrkontrollen kräver 2 x AAA-batterier. Storlek på VESA-fäste: 300 x 300 mm Förpackningens storlek (B x H x D): 1350 x 837 x 144 mm Apparatens storlek (B x H x D) med stativ: 1225,8 x 777,3 x 277,2 mm Apparatens storlek (B x H x D) utan stativ: 1225,8 x 719,4 x 88,1 mm Förpackningens vikt: 16,4 kg Apparatens vikt med stativ: 11,9 kg Apparatens vikt utan stativ: 11,4 kg

* Delarnas specifikationer för den här TV-apparaten tillhandahålls endast för referens.
Skillnader kan uppstå allt eftersom produktens teknik utvecklas.
Design och specifikationer kan ändras utan föregående meddelande.

PRODUKTSPECIFIKATIONER

65 tum UHD LED-TV

TV-apparatens bildkvalitet:	UHD Integrerad digital. Skärmens storlek: 164 cm Upplösning: 3840 x 2160 pixlar vid 60 Hz.
TV-systemet:	PAL-B/G, SECAM-B/G
DTV-avkodare	DVB-T, DVB-C, DVB-T2, DVB-S2 16/32/64/128/256 QAM-modulering MPEG2, MPEG4, H.265
Anslutningar:	1 optisk port 2 USB-portar 1 LAN 4 HDMI-uttag 1 VIDEO-uttag 1 L-uttag 1 R-uttag 2 RF-uttag 1 port för HÖRLURAR 1 CI-plats System som stöds: PAL+SECAM Antal kanaler som kan lagras: 1000 (DTV), 100 (ATV) TV (RF) :75 Ω impedans AV Video-ingång: 75 Ω, 1 V-P, RCA AV Audio-ingång: 20 KΩ, 500 mV RMS HDMI Video-ingång: 480i, 480p, 720p, 1080i, 1080p, 2160p Wi-Fi: Standard: IEEE 802.11a/b/g/n/ac, Frekvens: 2,4/5 GHz Bluetooth: V5.1
Ljudkvalitet:	Stereoljudsystem. 2 x 13,5 W RMS-ut effekt.
Strömförbrukning i standby	≤ 0,5 W
Digitala funktioner:	Digital interaktivitet. Digital text. Digital video broadcasting (DVB) -undertexter tillgängliga. Automatisk konfiguration. Automatisk sökning efter nya kanaler. Programguide med nuvarande och nästa program. Elektronisk programguide för 7 dagar (EPG). CI-plats. Kompatibel med ljudbeskrivning.
Ytterligare funktioner:	UHF/VHF-tuner, insomningstimer, föräldrahandledning, bild och text Fjärrkontrollen kräver 2 x AAA-batterier. Storlek på VESA-fäste: 400 x 300 mm Förpackningens storlek (B x H x D): 1600 x 960 x 164 mm Apparatens storlek (B x H x D) med stativ: 1446,4 x 904,7 x 313,8 mm Apparatens storlek (B x H x D) utan stativ: 1446,4 x 841,3 x 85,1 mm Förpackningens vikt: 24 kg Apparatens vikt med stativ: 17,2 kg Apparatens vikt utan stativ: 16,5 kg

* Delarnas specifikationer för den här TV-apparaten tillhandahålls endast för referens.
Skillnader kan uppstå allt eftersom produktens teknik utvecklas.
Design och specifikationer kan ändras utan föregående meddelande.

Haier

Haier

Надхненне життя

Посібник
користувача

МОДЕЛІ:

H43Q80FUX

H50Q80FUX

H55Q80FUX

H65Q80FUX



ілюстрації у цьому посібнику наведені тільки для довідки і можуть відрізнятися від вигляду справжнього пристрою.

Дизайн та характеристики виробу можуть бути змінені без попередження.

LED Телевізор

ЗМІСТ

1. ВАЖЛИВІ ІНСТРУКЦІЇ ЩОДО БЕЗПЕКИ	1
2. ПІДГОТОВКА	3
3. ПЕРИФЕРІЙНЕ ПІДКЛЮЧЕННЯ ТА КЕРУВАННЯ	5
4. ПІДКЛЮЧЕННЯ	6
5. ІНСТРУКЦІЯ З ВИКОРИСТАННЯ	7
6. УСУНЕННЯ НЕСПРАВНОСТЕЙ	20
7. ТЕХНІЧНІ ХАРАКТЕРИСТИКИ ВИРОБУ	21



ілюстрації у цьому посібнику наведені тільки для довідки і можуть відрізнятися від вигляду справжнього пристрою.



Дизайн та характеристики виробу можуть бути змінені без попередження.

ВАЖЛИВІ ІНСТРУКЦІЇ ЩОДО БЕЗПЕКИ

- 1) Прочитайте ці інструкції.
- 2) Збережіть цю інструкцію.
- 3) Уважно прочитайте усі застереження.
- 4) Дотримуйтесь усіх інструкцій.
- 5) Не використовуйте даний пристрій поблизу води.
- 6) Чистіть тільки сухою тканиною.
- 7) Не закривайте жодні вентиляційні отвори, встановлюйте згідно з інструкціями.
- 8) Не встановлюйте поблизу будь-яких джерел тепла, таких як радіатори, батареї опалення, печі або інші прилади (включаючи підсилювачі), що виділяють тепло.
- 9) Не змінюйте і не видаляйте конструктивні елементи поляризованої штепсельної вилки. Якщо штепсельна вилка не підходить до вашої розетки, зверніться до електрика, щоб він змінив вашу застарілу розетку.
- 10) Оберігайте шнур живлення від наступання на нього, а також від перетискання, особливо в місцях поблизу штепсельної вилки, електричної розетки та виходу шнура з апарата.
- 11) Використовуйте лише ті додатки та аксесуари, що були рекомендовані виробником.
- 12) Обов'язково відключайте цей пристрій від електричної розетки під час грози, або якщо ви не збираєтесь використовувати його упродовж тривалого часу.
- 13) Зверніться за обслуговуванням до кваліфікованого сервісного персоналу. Обов'язково здайте цей пристрій на сервісне обслуговування, якщо він у будь-який спосіб пошкоджений, якщо пошкоджений шнур живлення або штепсельна вилка, якщо на нього була пролита рідина або всередину пристрою потрапили якісь предмети, якщо пристрій потрапив під дощ або знаходився у вологому приміщенні, а також якщо він не працює належним чином або падав.
- 14) Штепсельна вилка використовується для відключення пристрою, тому вона повинна бути доступною для миттєвого відключення..
- 15) Не закривайте вентиляційні отвори сторонніми предметами, такими як газети, скатертини, штори тощо.
- 16) Не ставте на даний пристрій джерела відкритого вогню, наприклад, свічки тощо.
- 17) Під час утилізації акумуляторів враховуйте екологічні вимоги.
- 18) Цей пристрій призначений для використання у помірному кліматі.
- 19) Оберігайте даний пристрій від потрапляння на нього рідини або крапель, а також ніколи не ставте на нього посуд із рідиною, наприклад, вази тощо.
- 20) Застереження: Щоб уникнути травмування внаслідок перекидання цього пристрою, завжди ставте його горизонтально на рівній поверхні стола.

* Справжній вигляд виробу може відрізнятись від зображення вгорі*

Якщо у пристрої штепсельна вилка використовується для його відключення, тоді в інструкції зі встановлення повинно бути зазначено, що електрична розетка для підключення пристрою повинна бути легкодоступною.

	ЗАСТЕРЕЖЕННЯ НЕБЕЗПЕКА УРАЖЕННЯ СТРУМОМ НЕ ВІДКРИВАЙТЕ!	
ЗАСТЕРЕЖЕННЯ ЩОБ УНИКНУТИ УРАЖЕННЯ ЕЛЕКТРИЧНИМ СТРУМОМ, НЕ ЗНИМАЙТЕ КРИШКУ (АБО ЗАДНЮ ПАНЕЛЬ). ВСЕРЕДИНИ НЕМАЄ ДЕТАЛЕЙ ДЛЯ ОБСЛУГОВУВАННЯ КОРИСТУВАЧЕМ. ДОВІРТЕ СЕРВІСНЕ ОБСЛУГОВУВАННЯ КВАЛІФІКОВАНОМУ СЕРВІСНОМУ ПЕРСОНАЛУ.		



Цей символ позначає небезпечну напругу, присутню в цьому пристрої, що може призвести до ураження електричним струмом.



Цей символ позначає наявність важливих інструкцій з експлуатації та обслуговування в посібнику, що додається до даного пристрою.

ЗАСТЕРЕЖЕННЯ:

Щоб уникнути ризику пожежі або ураження електричним струмом, оберігайте цей пристрій від дощу або вологи.

ЗАСТЕРЕЖЕННЯ:

Батареї не повинні зазнавати надмірного нагрівання, наприклад, від сонячного проміння, вогню або інших джерел тепла.



Цей символ позначає, що у даному пристрої використовується подвійна ізоляція між небезпечною мережною напругою та деталями, доступними для користувача. При сервісному обслуговуванні використовуйте тільки ідентичні запчастини.



Це маркування вказує на те, що цей пристрій забороняється викидати разом із іншими побутовими відходами. Щоб уникнути можливої шкоди для навколишнього середовища або здоров'я людей від неконтрольованої утилізації відходів, здавайте їх на переробку, яка дозволяє знову використовувати відновлювані матеріали. Для повернення вашого пристрою скористайтесь системою повернення та приймання або зверніться до продавця, в якого ви придбали даний виріб. Вони можуть прийняти цей пристрій для його безпечної переробки.

ВАЖЛИВІ ІНСТРУКЦІЇ ЩОДО БЕЗПЕКИ

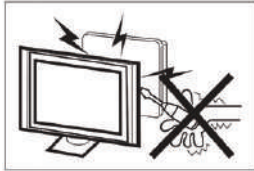

Для роботи телевізійного приймача використовуються високі напруги. Не знімайте задню кришку вашого телевізора. Довірте сервісне обслуговування кваліфікованому сервісному персоналу.

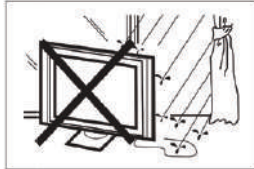

Для упередження небезпеки ураження електричним струмом оберігайте телевізор від дощу або вологи.



Не кидайте та не вставляйте предмети в прорізи або в отвори в корпусі телевізора. Не допускайте проливання на телевізор будь-яких рідин.



Не допускайте блокування вентиляційних отворів на задній кришці. Належна вентиляція є абсолютно необхідною для упередження несправності електричних деталей.



Не ставте телевізор на шнур живлення.



Якщо ви збираєтеся чистити цей виріб, відключіть телевізор від електричної розетки та чистіть м'якою тканиною без води, не використовуючи жодних хімічних засобів.



Ніколи не наступайте та не спирайтесь на телевізор або його підставку. Звертайте особливу увагу на дітей. Падіння виробу може призвести до серйозного травмування.

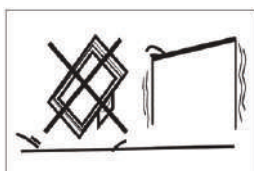

Не розташовуйте ваш телевізор на нестійкому візку, стенді, полиці або столі. Падіння може спричинити серйозне травмування користувачам та пошкодження для телевізора.



Якщо ви не плануєте використовувати телевізор упродовж тривалого часу, рекомендується відключити шнур живлення від електричної розетки.

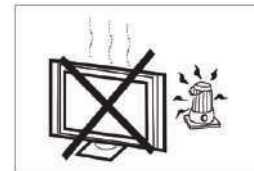

Оберігайте телевізор від прямого сонячного проміння та інших джерел тепла. Не ставте телевізор безпосередньо на інші вироби, що продукують тепло, такі як відеомагнітофони та підсилювачі звуку. Не ставте на телевізор джерела відкритого полум'я, такі як запалені свічки.

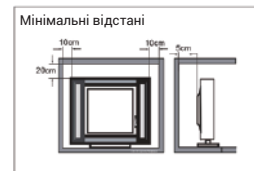

Якщо ви збираєтеся вбудувати телевізор у панель або інші схожі відсіки, дотримуйтесь рекомендацій щодо мінімальної відстані до корпусу телевізора. Перегрівання може зменшити термін служби вашого телевізора, а також бути небезпечним.

Примітка: використовуйте пристрій в помірному кліматі.

Застереження:

Телевізор може упасти, що може призвести до травмування та навіть смертельних випадків. Багатьох поранень, особливо поранень дітей, можна уникнути, дотримуючись наступних простих застережень:

- ЗАВЖДИ використовуйте корпуси, підставки та методи встановлення, рекомендовані виробником телевізора.
- ЗАВЖДИ використання ті меблі, які можуть безпечно витримувати встановлений на них телевізор.
- ЗАВЖДИ забезпечуйте, щоб телевізор не виступав за край меблів, на яких він встановлений.
- ЗАВЖДИ пояснюйте дітям небезпеку вилізання на меблі з метою досягання до телевізора або його органів керування.
- ЗАВЖДИ прокладайте шнури та кабелі, підключені до вашого телевізора, таким чином, щоб уникнути спотикання об них.
- НІКОЛИ не ставте телевізор на нестійких поверхнях.
- НІКОЛИ не встановлюйте телевізор на високих меблях (наприклад, на сервантах або книжкових шафах), не прикріпивши спершу ці меблі та телевізор до надійної опори.
- НІКОЛИ не ставте телевізор на скатертину або інші матеріали, якими можуть бути накріті меблі.
- НІКОЛИ не ставте на телевізор або меблі, на яких він стоїть, предмети, що можуть спонукати дітей залазити на них, наприклад, іграшки та пульти дистанційного керування.

Під час переміщення телевізора в інше місце обов'язково дотримуйтесь вищенаведених інструкцій.

ПІДГОТОВКА

ВАЖЛИВО: Не натискайте на екран дисплея, оскільки це може спричинити його пошкодження. Гарантія від виробника не покриває пошкодження, що виникли внаслідок неправильного використання або неналежного встановлення.

ПРИКРІПЛЕННЯ ПІДСТАВКИ

ВАЖЛИВО: Підставку телевізора потрібно зібрати перед її використанням.

1. Покладіть телевізор екраном донизу на м'яку та пласку поверхню (покривало, пінопласт, тканину тощо), щоб оберегти його від будь-якого пошкодження.
2. Прикріпіть підставку до нижньої панелі телевізора за допомогою 6 гвинтів.

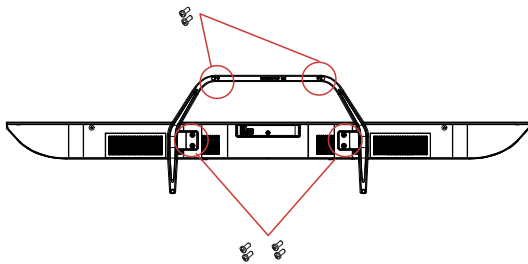

! ПРИМІТКА

Зображення виробу відповідає дійсному.

ПІДГОТОВКА ВАШОГО LED ТЕЛЕВІЗОРА ДО МОНТАЖУ НА СТІНІ

Щоб уникнути виникнення перешкод кабелів, рекомендуємо встановлювати телевізор на відстані щонайменше 60 мм від стіни. Перед тим як встановити ваш телевізор на стіні, потрібно зняти підставку.

З метою безпеки використовуйте тільки настінні кронштейни сертифіковані організацією Underwriters Laboratories (UL), розраховані на вагу, більшу ніж вага телевізора без підставки. Щоб прикріпити настінний кронштейн до вашого телевізора:

1. Викрутіть гвинти, що кріплять ваш телевізор до підставки.
2. Зніміть підставку з вашого телевізора.
3. Прикріпіть настінного кронштейн до задньої панелі вашого телевізора за допомогою чотирьох гвинтів. Для встановлення дотримуйтесь інструкцій у посібнику користувача, що додається до настінного кронштейна.

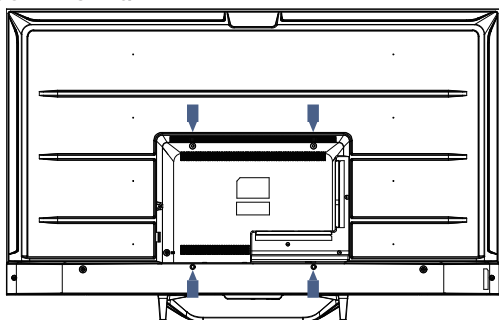

! ПРИМІТКА

Настінний кронштейн не входить у комплект.

4. Закрутіть гвинти настінного монтажу (M6x12мм/4шт.) у задню панель LED телевізора з крутним моментом 12 кгс·см.

УВІМКНЕННЯ ТЕЛЕВІЗОРА

1. Встановіть підставку та помістіть телевізор на надійну поверхню.

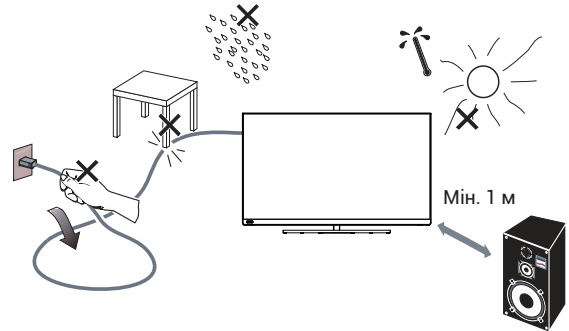

! ПРИМІТКА

- Забезпечте належну вентиляцію у місці встановлення телевізора. Не закривайте вентиляційні отвори на задній панелі.
 - Щоб уникнути виникнення небезпечних ситуацій, не ставте джерела відкритого полум'я, такі як запалені свічки, на або біля телевізора.
 - Оберегайте від високих температур, прямого сонячного проміння, а також дощу та води. Оберегайте цей пристрій від крапель та бризок води.
2. Підключіть кабель антени або кабельного телебачення до гнізда антени **ANT IN** на задній панелі телевізора.
 3. Пульт дистанційного керування: Зніміть кришку батарейного відсіку. Вставте 2 батарейки (Типу AAA 1,5В).

ЗАСТЕРЕЖЕННЯ: Під час заміни батарейок на батарейки неправильного типу існує ризик вибуху.

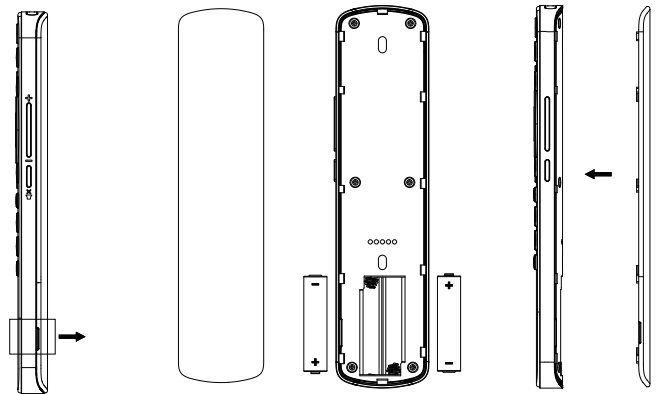

ПІДГОТОВКА

4. Потужність:
Підключіть шнур живлення до робочої електричної розетки.

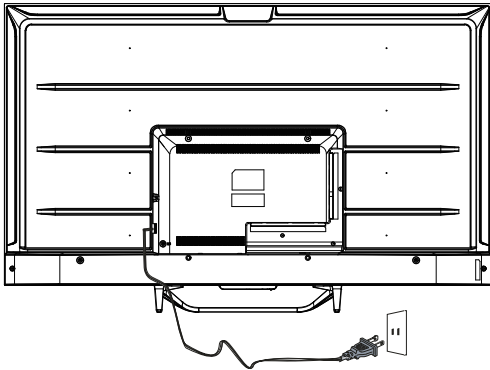

5. Увімкніть телевізор:
Натисніть **⏻** на пульті дистанційного керування або кнопку **POWER** на боковій панелі керування телевізора.

ПЕРИФЕРІЙНЕ ПІДКЛЮЧЕННЯ ТА КЕРУВАННЯ

КЕРУВАННЯ КНОПКАМИ

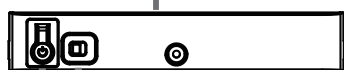
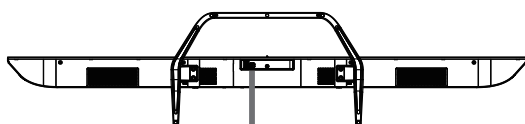
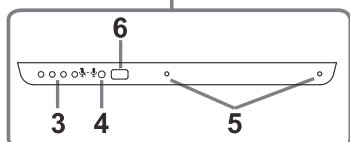
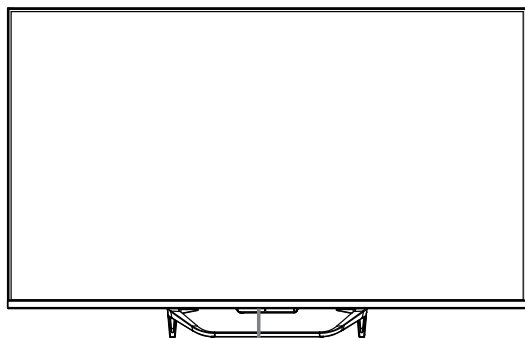

1. Живлення Увімк. / Вимк.
2. Функція голосу Увімк. / Вимк.

🗣️ Увімкнути функцію дистанційного помічника

🗣️ Вимкнути функцію дистанційного помічника

Перемістіть вправо, щоб увімкнути функцію голосу, водночас загориться та знову погасне світловий індикатор, показуючи, що функцію голосу увімкнено. Тепер скажіть "Ok Google" та зачекайте, доки загориться світловий індикатор, а тоді скажіть ваш запит.

Перемістіть вліво, щоб вимкнути функцію голосу, водночас світловий індикатор змінить колір на жовтий.

3. Світловий індикатор дистанційного помічника
4. Приймач сигналів від пульта дистанційного керування
5. Приймач голосових сигналів
6. Індикатор живлення

! ПРИМІТКА

Перед використанням функції голосу підключіть ваш телевізор до інтернету. Увімкніть, перед тим як використовувати функцію голосу. Увійдіть у ваш обліковий запис GOOGLE, перед тим як використовувати функцію голосу.

АКСЕСУАРИ

Пульт дистанційного керування – 1 шт.

Посібник користувача – 1 шт.

Гвинти - 6 шт.

Довідник зі швидкого запуску – 1 шт.

Гарантійний талон – 1 шт.

ПІДКЛЮЧЕННЯ ПЕРИФЕРІЇ



Усі роз'єми (зліва направо):
LAN, OPTICAL, VIDEO, L, R, HDMI4, HDMI3, HDMI2,



Усі роз'єми (зліва направо):
HDMI1 (eARC/ARC), LNB IN (SATELLITE), ANT IN (ANTENNA/CABLE), USB1, USB2, EARPHONE, CI.

ПІДКЛЮЧЕННЯ

АВ ОБЛАДНАННЯ

Цей телевізор оснащений однією групою АВ (аудіовізуальних) роз'ємів для зручного підключення відеомагнітофонів, DVD та іншого відеообладнання.

Будь ласка, ознайомтеся також із посібником користувача обладнання, яке буде підключатись.

Ви можете використовувати вхідні роз'єми на задній панелі телевізора, як описано нижче.

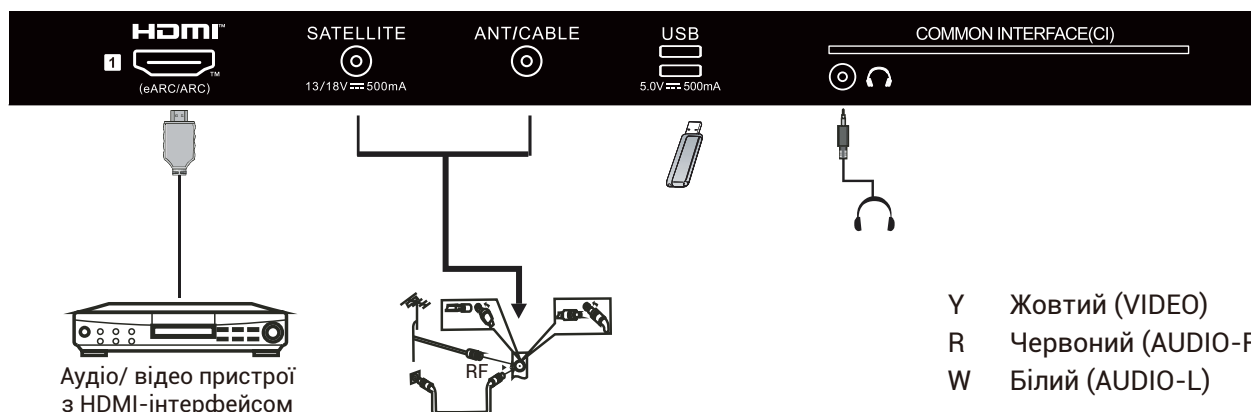
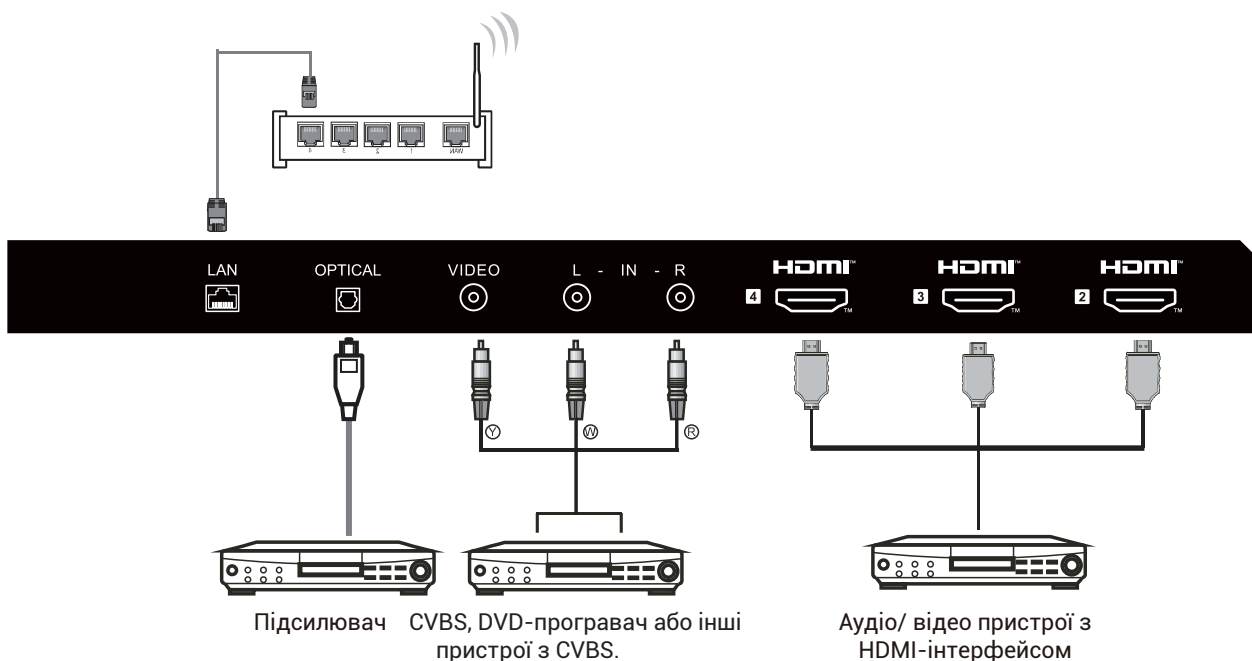

Його можна підключити до таких пристроїв: відеомагнітофони, багатодискові програвачі, DVD, відеокамери, ігрові приставки, стереосистеми тощо.

Примітка:

Часом телевізор не підтримує деякі пристрої, оскільки вони передають нестандартний сигнал.

ІНСТРУКЦІЯ З ВИКОРИСТАННЯ

ВИКОРИСТАННЯ ПУЛЬТА ДИСТАНЦІЙНОГО КЕРУВАННЯ

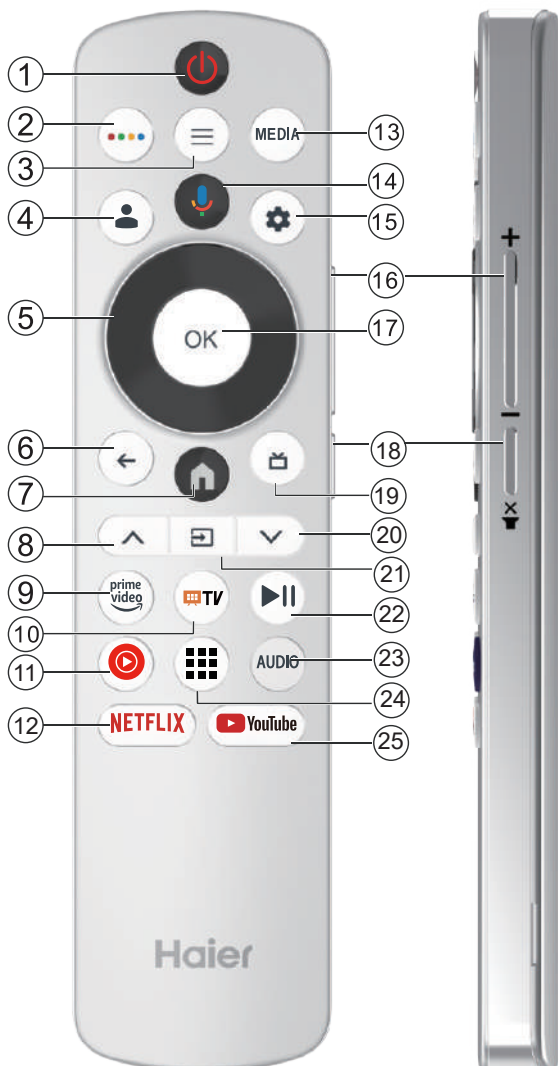

#	Елемент	Опис
1	 Живлення	Натисніть, щоб увімкнути або вимкнути телевізор. Коли ваш телевізор вимкнений, струм однаково проходить через нього. Щоб повністю відключити живлення, відключіть шнур живлення від електричної розетки.
2		Натисніть, щоб відкрити MAGIC BOARD.
3		Натисніть, щоб відкрити або закрити екранне меню.
4		Натисніть для реєстрації та доступу до облікового запису Google TV. (Під час першого налаштування телевізора ця клавіша не активна)
5		Натисніть для навігації в екранному меню.
6		Повернення до попереднього меню.
7		Натисніть, щоб відкрити головну сторінку.
8		Натискайте для зміни телеканалів.
9	 prime video	Натисніть для доступу до Prime Video для перегляду онлайн телевізійних шоу та фільмів (потрібне підключення до інтернету).
10	 TV	Натисніть, щоб відкрити Live TV.
11		Натисніть, щоб відкрити YouTube Music.
12	 NETFLIX	Натисніть, щоб відкрити NETFLIX.
13	MEDIA	Натисніть, щоб відкрити мультимедійний програвач Multi Media Player.
14		Натисніть, щоб відкрити Google Assistant або розпочати голосовий пошук.
15		Натисніть, щоб в меню налаштування.
16	ГУЧ+ГУЧ-	Натисніть ГУЧ+ або ГУЧ- для налаштування рівня гучності.
17	OK	Введення вибраної опції або виконання вибраної операції.
18		Натисніть для приглушення або відновлення звучання.
19		Натисніть для відображення електронного розкладу програм в режимі ТБ.
20		Натискайте для зміни телеканалів.
21		Натисніть, щоб відкрити список вхідних роз'ємів.
22		Натисніть для відтворення/паузи в мультимедійному режимі.
23	AUDIO	Натискайте для перемикання звукових доріжок.
24		Натисніть, щоб відкрити застосунки.
25	YouTube	Натисніть, щоб відкрити YouTube.

ІНСТРУКЦІЯ З ВИКОРИСТАННЯ

ПОЧАТКОВЕ НАЛАШТУВАННЯ

Під час першого увімкнення телевізора майстер налаштування проведе вас через налаштування основних настройок.

Будь ласка, дотримуйтесь текстових порад для виконання первинного налаштування.

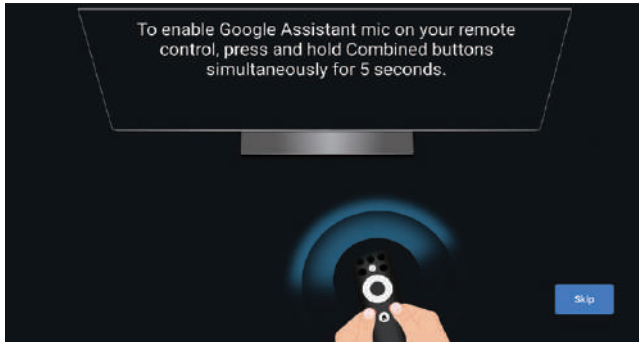

Ця функція використовується для введення коду створення пари з пультом дистанційного керування. У разі введення правильного коду, ви можете використовувати пульт дистанційного керування Bluetooth для керування вашим телевізором.

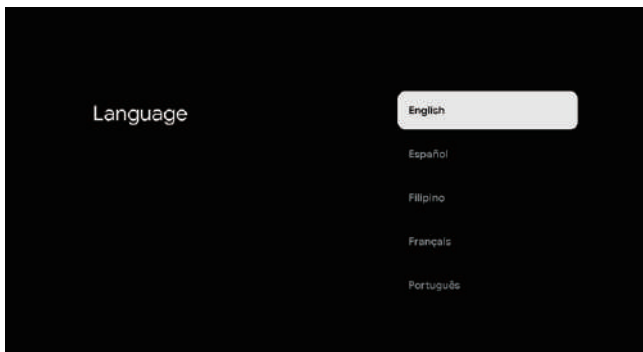

Натискайте ▲/▼ для вибору системної мови, а тоді натисніть **OK** для підтвердження мови.

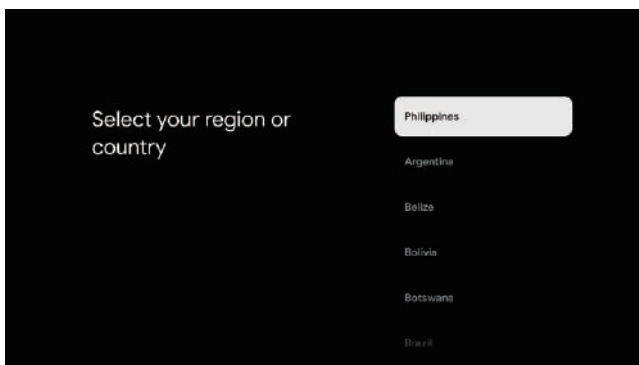

Натискайте ▲/▼, щоб вибрати регіон/країну вашого пристрою, а тоді натисніть **OK** для підтвердження.

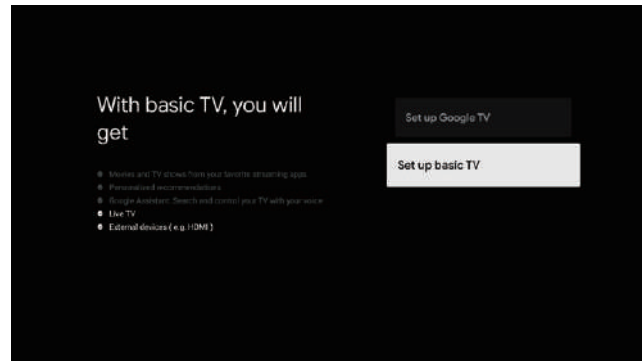

Натискайте ▲/▼, щоб вибрати «Set up basic TV» (Основні налаштування телевізора) для вашого пристрою, а тоді натисніть **OK** для завершення налаштування..

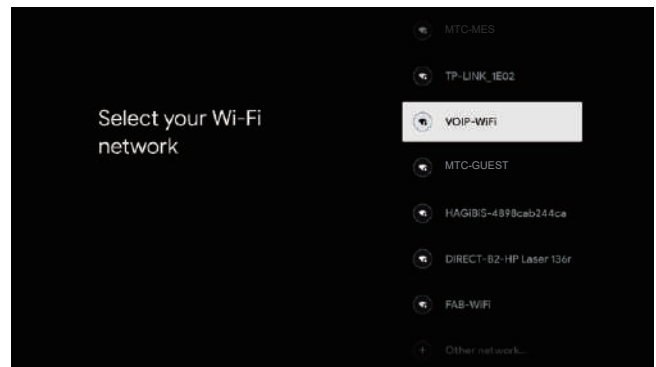

Натискайте ▲/▼, щоб вибрати мережу wifi для підключення, а тоді натисніть **OK** та введіть пароль, щоб підключитись до неї.

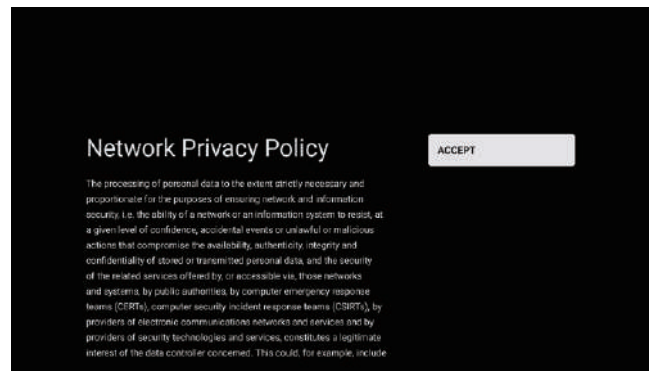

Виберіть «Асепт» (Прийняти), щоб прийняти умови політики конфіденційності мережі.

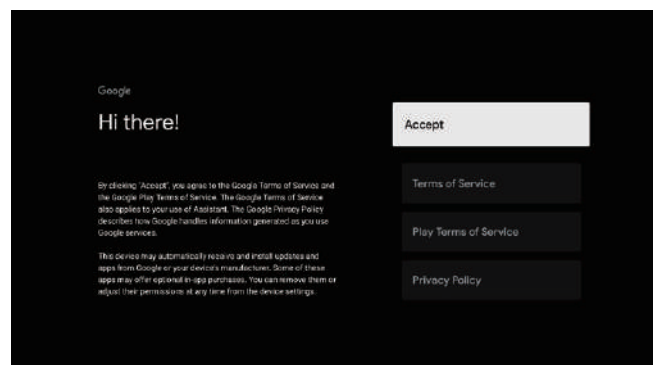

Якщо ви бажаєте прийняти умови обслуговування Google для вдосконалення виробу, виберіть «Асепт» (Прийняти).

ІНСТРУКЦІЯ З ВИКОРИСТАННЯ

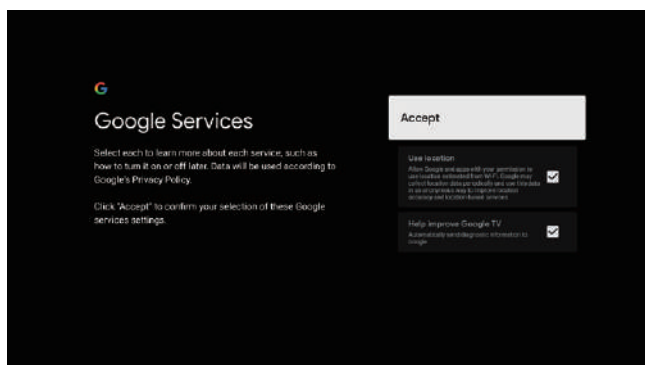

Якщо ви бажаєте прийняти обслуговування Google для вдосконалення виробу, виберіть «Асерт» (Прийняти).

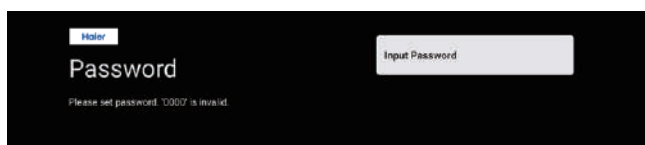

Використовується для налаштування паролю вашого пристрою для забезпечення безпеки та приватності.

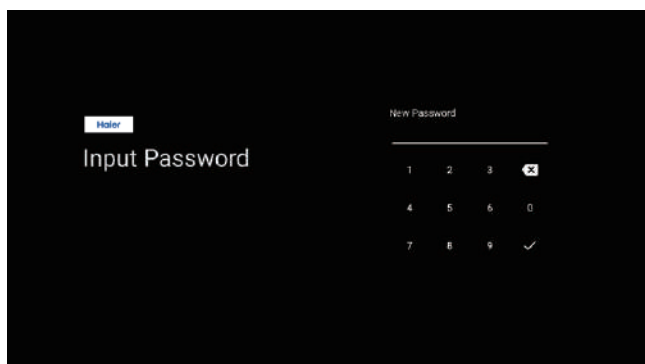

За допомогою пульта дистанційного керування/екранної клавіатури введіть 4-значний пароль, щоб автоматично перейти до наступної сторінки.

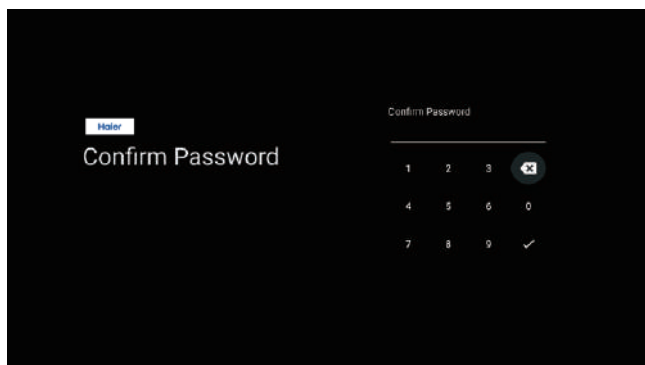

Підтвердіть пароль ще раз, увівши його знову за допомогою пульта дистанційного керування/екранної клавіатури.

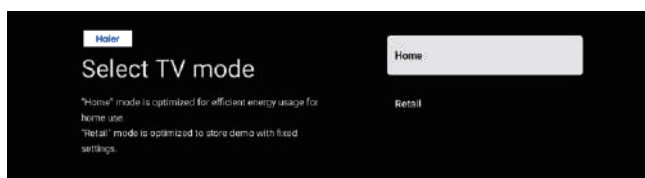

Натискайте клавіші ▲/▼, щоб вибрати режим «Home» (Дім), а тоді натисніть ОК.

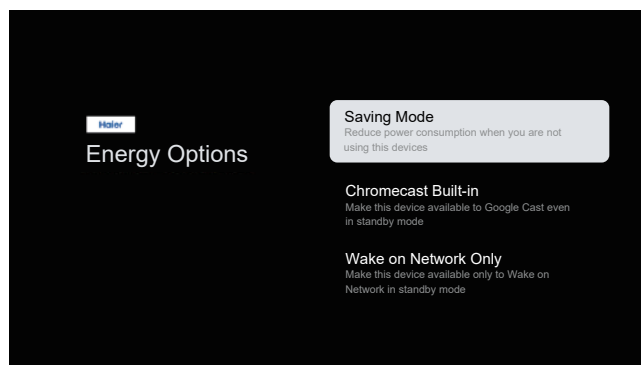

Виберіть «Saving Mode» (Режим енергозбереження) та перейдіть до наступного кроку.

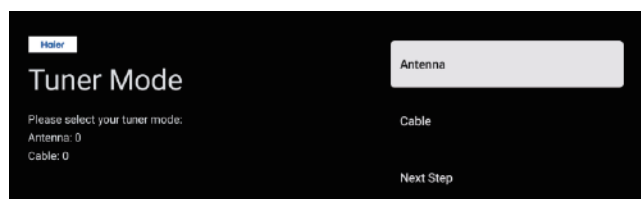

Виберіть режим «Tuner mode» (Режим тюнера) для пошуку, натисніть, щоб вибрати, а тоді натисніть ОК для підтвердження.

ІНСТРУКЦІЯ З ВИКОРИСТАННЯ

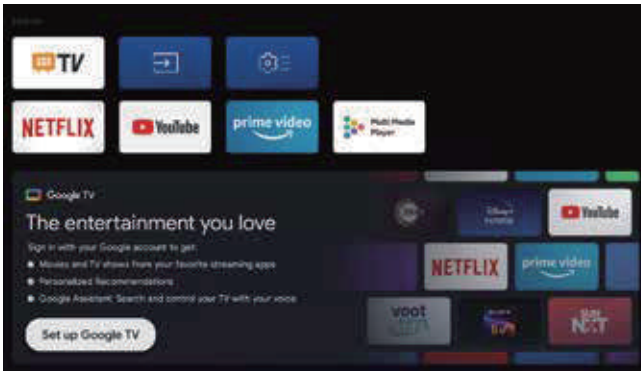

- На сторінці користувача ви можете перемкнути телевізор з основних налаштувань телевізора на налаштування Google TV.

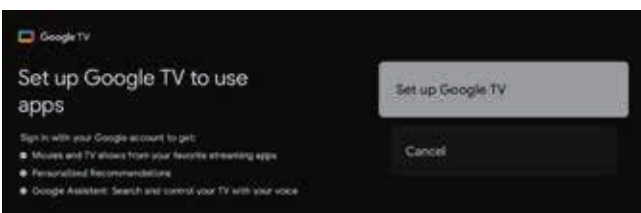

Натискайте ▲/▼, щоб вибрати «Set up Google TV» на вашому пристрої, а тоді натисніть ОК, щоб завершити налаштування.

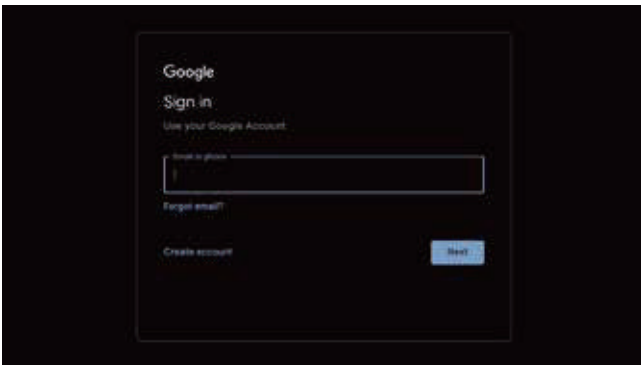

Використовуйте ваш обліковий запис Google для входу в систему.

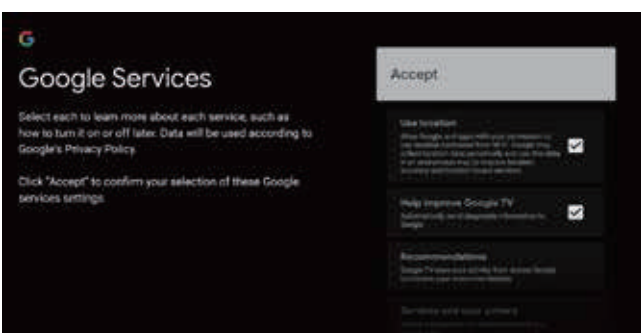
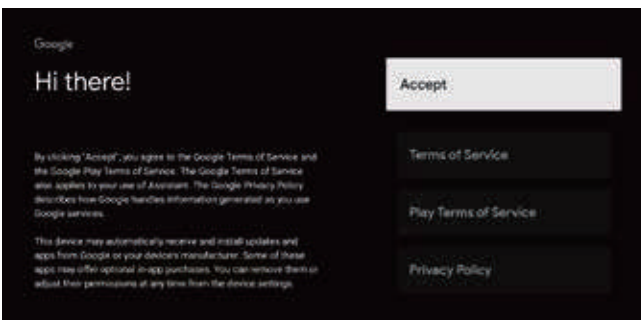

Якщо ви бажаєте прийняти умови обслуговування Google для вдосконалення виробу, виберіть «Асерт» (Прийняти).

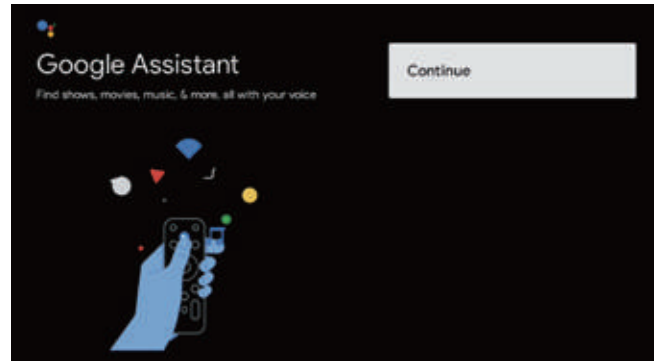

Натисніть, щоб вибрати, а тоді натисніть ОК, щоб продовжити.

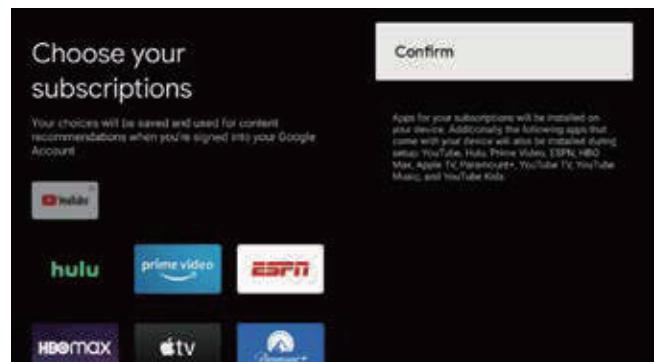

Натискайте ▲/▼, щоб вибрати «Choose your subscriptions» (Виберіть ваші підписки), та натисніть ОК.

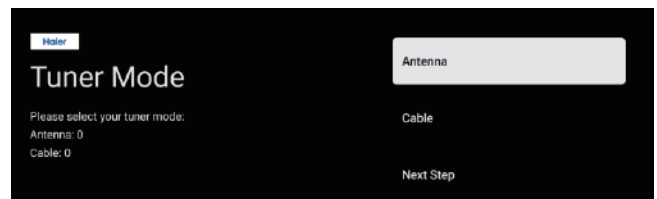

ІНСТРУКЦІЯ З ВИКОРИСТАННЯ

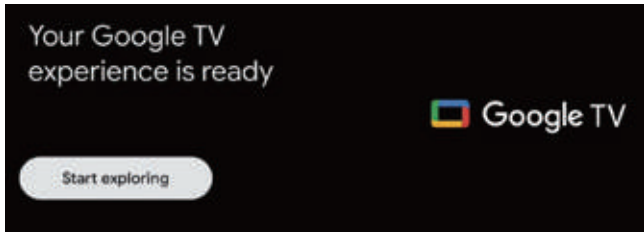

Налаштування Google TV завершено; натисніть ОК, а тоді натисніть «Start exploring» (Розпочати роботу).

ГОЛОВНИЙ ЕКРАН

Завершивши налаштування вийдіть на головний екран, щоб розпочати перегляд.

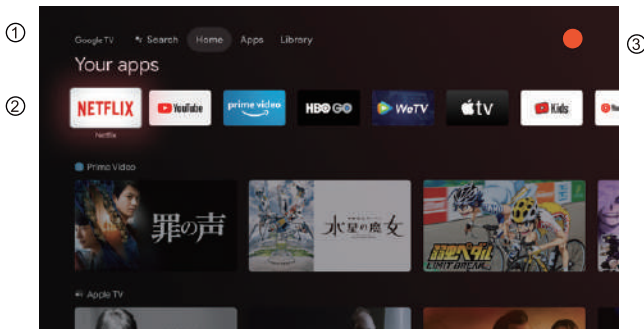

- ① **Search** Відкрийте Google Assistant або використовуйте голосовий пошук.
Home Відкрийте головну сторінку вашого телевізора.
Apps Відкрийте список встановлених застосунків та додайте ваші вибрані застосунки.
Library Переглядайте ваші придбані або взяті на прокат відеозаписи в обліковому записі користувача.
- ② Список встановлених застосунків та push-вмісту встановлених програм.

- ③ Перегляд вашої інформації про обліковий запис, налаштування, час, входи та зображення.

⊗ **Налаштування:** Тут можна налаштувати різні настройки. Детальніші дані щодо налаштувань див. у наступному роз'ясненні.

⊞ **Входи:** Ви можете вибрати джерела входу.

⊞ **Зображення:** Користувач може налаштувати зображення телевізора. Див. стор. 12 для отримання детальніших інструкцій щодо налаштування.

НАВІГАЦІЯ В ЕКРАННОМУ МЕНЮ

Є два способи входу. Спершу в режимі телебачення наживо натисніть кнопку меню, щоб відобразити опцію телевізора, натискайте ▲/▼/◀/▶, щоб вибрати налаштування меню, а тоді натисніть кнопку ОК для підтвердження. Далі на сторінці HOME (Головна) натисніть клавішу ► для вибору значка меню ⚙️, а тоді натисніть ОК для підтвердження.

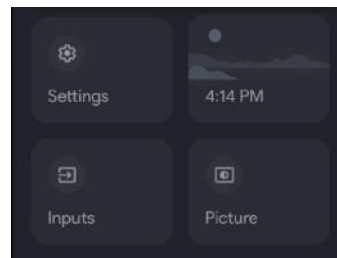
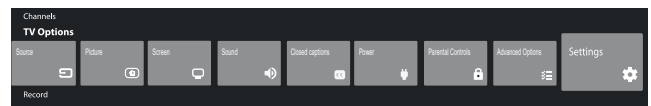

Натискайте кнопку ▲/▼, щоб вибрати елемент для налаштування. Натисніть ОК, щоб відкрити налаштування.

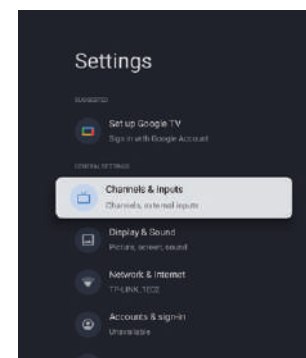

Натисніть BACK (Назад) для повернення до попереднього меню. Якщо відображається головне меню, натискання клавіші BACK закриє екранне меню.

ІНСТРУКЦІЯ З ВИКОРИСТАННЯ

КАНАЛИ

Menu -> Settings -> Channels & Inputs -> Channels (Меню -> Налаштування -> Канали та входи -> Канали).

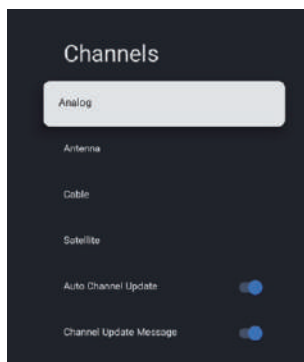

Analog/Antenna/Cable/Satellite (Аналог./Антенa/Кабель/Супутник) – натисніть кнопку ▲/▼ для вибору необхідної опції, а потім натисніть кнопку ОК для переходу в підменю.

Auto Channel Update (Автоматичне оновлення каналу) – натисніть кнопку ОК для вибору ON/OFF (УВІМК./ВИМК.). Якщо вибрати ON (УВІМК.), система автоматично скануватиме й оновлюватиме канали через 5 хвилин перебування у режимі очікування.

Channel Update Message (Повідомлення про оновлення каналу) – натисніть на кнопку ОК для вибору ON/OFF(УВІМК./ВИМК.). Якщо вибрати ON (УВІМК.), система покаже вам повідомлення про оновлення.

Примітка: доступне джерело може відрізнитися залежно від моделі.

ВХОДИ

Menu (Меню) ->Settings (Налаштування) ->Channels & Inputs (Канали та входи)

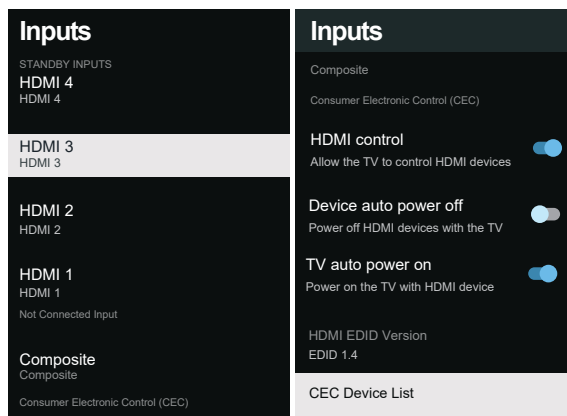

Inputs (Входи) – натискайте клавіші ▲/▼, щоб вибрати опцію, а тоді натисніть кнопку ОК, щоб увійти в підменю.

HDMI control (HDMI-керування) – натискайте клавіші ▲/▼, щоб вибрати опцію, а тоді натисніть кнопку ОК, щоб вибрати УВІМК./ВИМК.

Device auto power off (Автоматичне вимкнення пристрою) – Натискайте клавіші ▲/▼, щоб вибрати опцію, а тоді натисніть кнопку ОК, щоб вибрати УВІМК./ВИМК.

TV auto power on (Автоматичне увімкнення телевізора) – натискайте клавіші ▲/▼, щоб вибрати опцію, а тоді натисніть кнопку ОК, щоб вибрати УВІМК./ВИМК.

HDMI EDID Version (Версія HDMI EDID) – показує версію EDID.

CEC Device List (Список пристроїв CEC) – Натискайте клавіші ▲/▼, щоб вибрати опцію, а тоді натисніть кнопку ОК, щоб увійти в підменю.

ЗОБРАЖЕННЯ ТА ЗВУК

Menu (Меню) ->Settings (Налаштування) -> Display & Sound (Зображення та звук)

В цьому меню можна налаштувати зображення,

ІНСТРУКЦІЯ З ВИКОРИСТАННЯ

звук та аудіовихід телевізора.

1. Натискайте кнопку ▲/▼, щоб вибрати елемент для налаштування.
2. Натисніть кнопку ОК, щоб підтвердити.
3. Після завершення налаштування натисніть кнопку **ВАСК(Назад)**, щоб повернутися до попереднього меню.

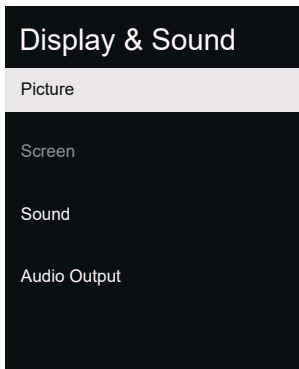

ЗВУК

Menu (Меню) ->Settings (Налаштування) -> Display & Sound (Зображення та звук) -> Sound (Звук).

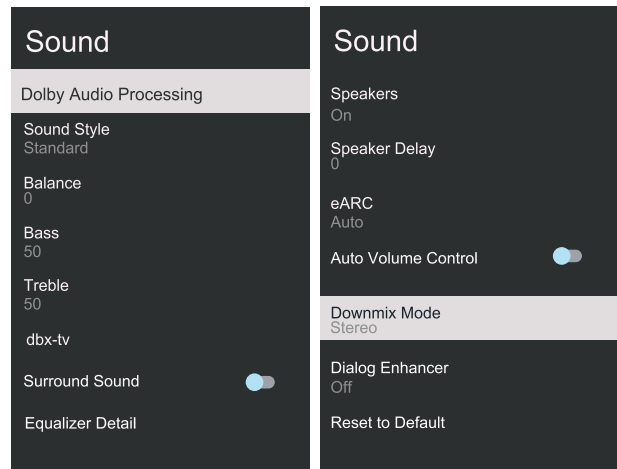

ЗОБРАЖЕННЯ

Menu (Меню) ->Settings (Налаштування) -> Display & Sound (Зображення та звук) -> Picture (Зображення).

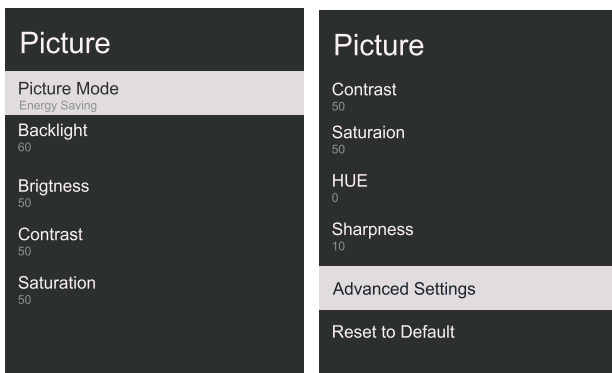

Picture Mode (Режим зображення) – натискайте клавіші ▲/▼, щоб вибрати опцію, а тоді натисніть кнопку ОК, щоб увійти в підменю.

(Доступні параметри: Користувацький, Стандартний, Яскравий, Спорт, Кінофільм, Гра, Енергозбереження).

Backlight(Підсвічування)/Brightness(Яскравість)/ Contrast(Контрастність)/Saturation(Насичення)/ HUE(Відтінок)/Sharpness(Різкість) – натискайте клавіші ▲/▼, щоб вибрати опцію, а тоді натисніть кнопку ОК для входу.

Натисніть ◀ для зменшення параметра.

Натисніть ▶ для збільшення параметра.

Advanced Settings (Розширені налаштування) – натискайте клавіші ▲/▼, щоб вибрати опцію, а тоді натисніть кнопку ОК, щоб увійти в підменю.

Reset to Default (Скинути до стандартних) – скидання всіх налаштувань до заводських налаштувань за замовчуванням.

Dolby Audio processing (Обробка Dolby Audio) – натискайте клавіші ▲/▼, щоб вибрати опцію, а тоді натисніть кнопку ОК, щоб увійти в підменю.

Sound style (Стиль звуку) – натискайте клавіші ▲/▼, щоб вибрати опцію, а тоді натисніть кнопку ОК, щоб увійти в підменю.

(Доступні параметри: Користувацький, Стандартний, Ніч, Спорт, Кінофільм, Музика, Новини).

Balance/ Bass/ Treble (Баланс/ Нижні частоти/ Верхні частоти) – натискайте клавіші ▲/▼, щоб вибрати опцію, а тоді натисніть кнопку ОК, щоб увійти в підменю.

Натисніть ◀ для зменшення параметра.

Натисніть ▶ для збільшення параметра.

dbx- tv – натискайте клавіші ▲/▼, щоб вибрати опцію, а тоді натисніть кнопку ОК, щоб увійти в підменю.

Surround Sound (Об'ємне звучання) – натискайте клавіші ▲/▼, щоб вибрати опцію, а тоді натисніть кнопку ОК, щоб вибрати УВІМК./ВИМК.

Equalizer Detail (Еквалайзер) – натискайте клавіші ▲/▼, щоб вибрати опцію, а тоді натисніть кнопку ОК, щоб увійти в підменю.

Speakers (Динаміки) – натискайте клавіші ▲/▼, щоб вибрати опцію, а тоді натисніть кнопку ОК, щоб вибрати УВІМК./ВИМК.

Speaker Delay (Затримка динаміка) – натискайте клавіші ▲/▼, щоб вибрати опцію, а тоді натисніть кнопку ОК, щоб увійти в підменю.

Натисніть ◀ для зменшення параметра.

Натисніть ▶ для збільшення параметра.

eARC – натискайте клавіші ▲/▼, щоб вибрати опцію, а тоді натисніть кнопку ОК, щоб вибрати Авто./ВИМК.

Auto Volume Control (Автоматичне керування гучністю) – ▲/▼, щоб вибрати опцію, а тоді натисніть кнопку ОК, щоб вибрати УВІМК./ВИМК.

Downmix Mode (Режим зменшувального міксування) – натискайте клавіші ▲/▼, щоб

ІНСТРУКЦІЯ З ВИКОРИСТАННЯ

вибрати опцію, а тоді натисніть кнопку **ОК**, щоб увійти в підменю.

(Доступні параметри: Стерео, Об'ємне звучання).

Dialog Enhancer (Підсилення діалогів) –

натискайте клавіші **▲/▼**, щоб вибрати опцію, а тоді натисніть кнопку **ОК**, щоб увійти в підменю.

(Доступні параметри: Вимк., Низьке, Середнє та Високе)

Reset to Default (Скинути до стандартних) –

скидання всіх налаштувань до заводських налаштувань за замовчуванням.

АУДІОВИХІД

Menu (Меню) ->Settings (Налаштування) -> Display & Sound (Зображення та звук) -> Audio Output (Аудіовихід).

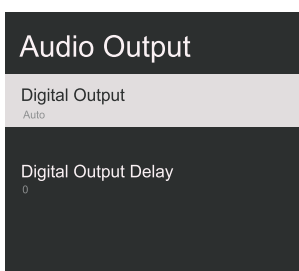

Digital Output (Цифровий вихід) – натискайте клавіші **▲/▼**, щоб вибрати опцію, а тоді натисніть кнопку **ОК**, щоб увійти в підменю. (Доступні параметри: Auto (Авто), Bypass (Обхід), PCM, Dolby Digital Plus та Dolby Audio-Dolby Digital).

Digital Output Delay (Цифрова затримка виходу) – натискайте клавіші **▲/▼**, щоб вибрати опцію, а тоді натисніть кнопку **ОК**, щоб увійти в підменю.

Натисніть **◀** для зменшення параметра.

Натисніть **▶** для збільшення параметра.

МЕРЕЖА

Menu (Меню) ->Settings (Налаштування) ->Network & Internet (Мережа та інтернет)

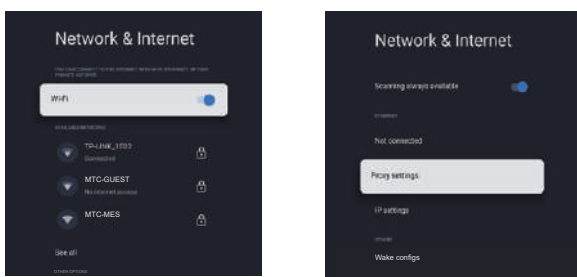

1. Натискайте кнопку **▲/▼**, щоб вибрати елемент для налаштування.
2. Натисніть кнопку **ОК**, щоб підтвердити.
3. Після завершення налаштування натисніть кнопку **ОК**, щоб зберегти та повернутися до попереднього меню.

ACCOUNTS & SIGN IN (ОБЛІКОВІ ЗАПИСИ ТА РЕЄСТРАЦІЯ)

1. Menu (Меню) ->Settings (Налаштування) ->Accounts & sign-in.(Облікові записи та реєстрація).
2. На сторінці HOME (Головна) натискайте клавіші **▲/▼** щоб вибрати «Set up Google TV» (Налаштування Google TV) та перейти до наступного кроку.

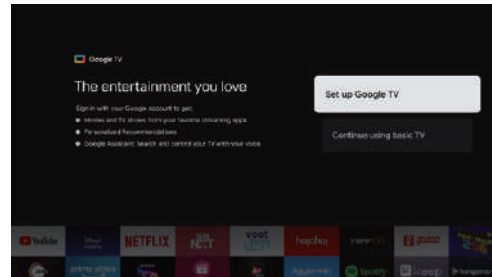

Виберіть «Set up Google TV» (Налаштування Google TV) та перейдіть до наступного кроку: введіть ваше ім'я облікового запису та пароль. Після цього виконайте підказки, щоб завершити відповідні налаштування.

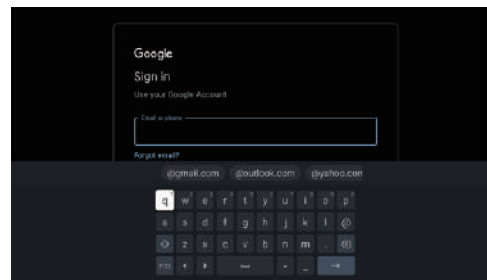

ПРИВАТНІСТЬ

Menu (Меню) ->Settings (Налаштування) ->Privacy (Приватність).

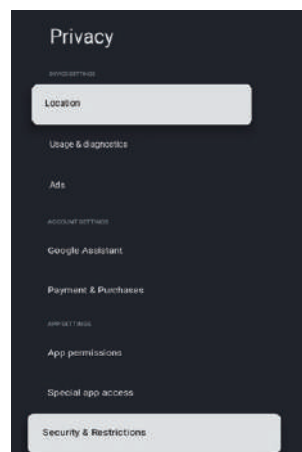

В цьому меню ви можете налаштувати місцезнаходження, інформацію про використання та діагностику вашого телевізора тощо.

1. Натискайте кнопку **▲/▼**, щоб вибрати елемент для налаштування.
2. Натисніть кнопку **ОК**, щоб підтвердити.

ІНСТРУКЦІЯ З ВИКОРИСТАННЯ

- Після завершення налаштування натисніть кнопку **BACK**(Назад), щоб повернутися до попереднього меню.

LOCATION (МІСЦЕЗНАХОДЖЕННЯ)

Menu (Меню) ->Settings (Налаштування) ->Privacy (Приватність). ->Location (Місцезнаходження).

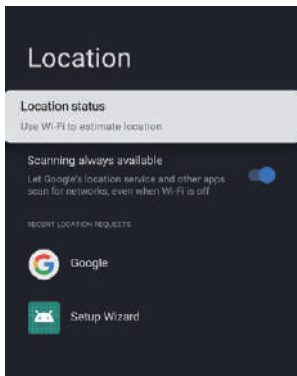

Location status (Стан місцезнаходження) – натискайте клавіші **▲/▼**, щоб вибрати опцію, а тоді натисніть кнопку **OK**, щоб увійти в підменю. (Доступні параметри: Використовувати Wi-Fi для визначення місцезнаходження, Вимк.)

Scanning always available (Сканування завжди доступне) – натискайте клавіші **▲/▼**, щоб вибрати опцію, а тоді натисніть кнопку **OK**, щоб вибрати УВИМК./ВИМК.

ВИКОРИСТАННЯ ТА ДІАГНОСТИКА

Menu (Меню) ->Settings (Налаштування) ->Privacy (Приватність). ->Usage & diagnostics (Використання та діагностика)

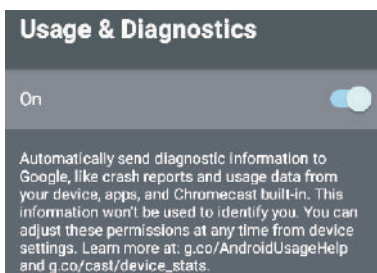

Usage & diagnostics (Використання та діагностика) – натискайте клавіші **▲/▼**, щоб вибрати опцію, а тоді натисніть кнопку **OK**, щоб вибрати УВИМК./ВИМК.

ЗАСТОСУНКИ

Menu (Меню) ->Settings (Налаштування) ->Apps (Застосунки).

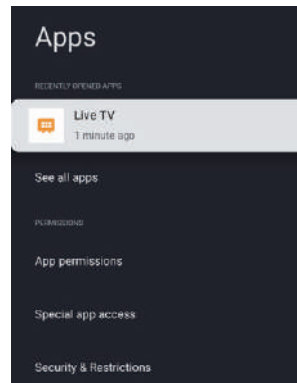

В цьому меню ви можете налаштувати дозволи застосунків та переглянути список застосунків.

- Натискайте кнопку **▲/▼**, щоб вибрати елемент для налаштування.
- Натисніть кнопку **OK**, щоб підтвердити.
- Після завершення налаштування натисніть кнопку **BACK**(Назад), щоб повернутися до попереднього меню.

СИСТЕМА

Menu (Меню) ->Settings (Налаштування) ->System (Система).

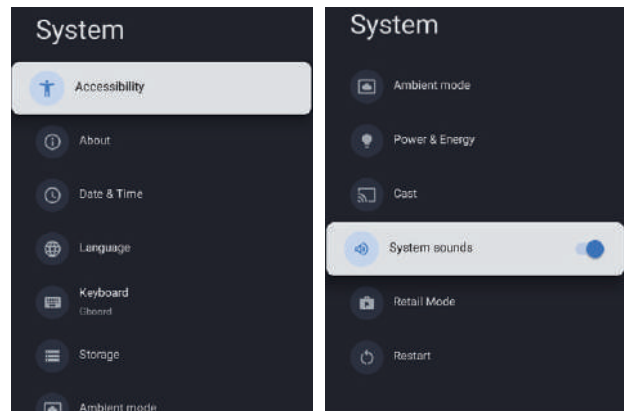

В цьому меню ви можете ознайомитися з інформацією та налаштуваннями вашого телевізора.

- Натискайте кнопку **▲/▼**, щоб вибрати елемент для налаштування.
- Натисніть кнопку **OK**, щоб підтвердити.
- Після завершення налаштування натисніть кнопку **BACK**(Назад), щоб повернутися до попереднього меню.

System sounds (Системні звуки) - натискайте клавіші **▲/▼**, щоб вибрати опцію, а тоді натисніть кнопку **OK**, щоб вибрати УВИМК./ВИМК.

Детальніші дані щодо системи див. у наступному поясненні.

ІНСТРУКЦІЯ З ВИКОРИСТАННЯ

ДОСТУПНІСТЬ

Menu (Меню) ->Settings (Налаштування) ->System (Система) -> Accessibility (Доступність).

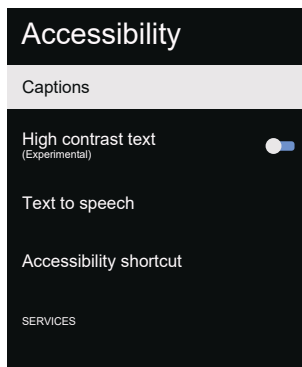

Captions (Субтитри) – натискайте клавіші ▲/▼, щоб вибрати опцію, а тоді натисніть кнопку ОК, щоб увійти в підменю.

High contrast text (Висока контрастність тексту) – натискайте клавіші ▲/▼, щоб вибрати опцію, а тоді натисніть кнопку ОК, щоб вибрати УВІМК./ВИМК.

Text to speech (Текст на мову) – натискайте клавіші ▲/▼, щоб вибрати опцію, а тоді натисніть кнопку ОК, щоб увійти в підменю.

Accessibility shortcut (Ярлики доступності) – натискайте клавіші ▲/▼, щоб вибрати опцію, а тоді натисніть кнопку ОК, щоб увійти в підменю.

ПРО

Menu (Меню) ->Settings (Налаштування) ->System (Система) ->About (Про).

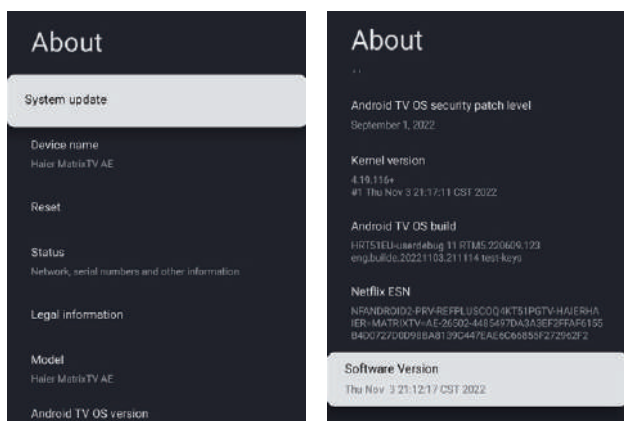

В цьому меню ви можете оновити систему, скинути та ознайомитись із даними про телевізор.

1. Натискайте кнопку ▲/▼, щоб вибрати елемент для налаштування.
2. Натисніть кнопку ОК, щоб підтвердити.
3. Після завершення налаштування натисніть кнопку BACK(Назад), щоб повернутися до попереднього меню.

ДАТА ТА ЧАС

Menu (Меню) ->Settings (Налаштування) ->System (Система) -> Date & Time (Дата та час).

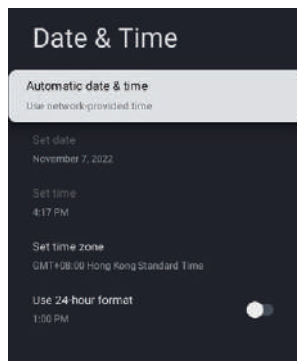

Automatic date & time (Автоматична дата та час) – натискайте клавіші ▲/▼, щоб вибрати опцію, а тоді натисніть кнопку ОК, щоб увійти в підменю. (Доступні параметри: Використовувати час наданий мережею, Вимк.)

ПРИМІТКА

- Коли Automatic date & time (Автоматичні дата й час) встановлено на OFF (ВИМК.), можна використовувати налаштування дати й часу вручну.

Set date (Налаштувати дату) – натискайте клавіші ▲/▼, щоб вибрати опцію, а тоді натисніть кнопку ОК, щоб увійти в підменю.

Set time (Налаштувати час) – натискайте клавіші ▲/▼, щоб вибрати опцію, а тоді натисніть кнопку ОК, щоб увійти в підменю.

Set time zone (Налаштувати часовий пояс) – натискайте клавіші ▲/▼, щоб вибрати опцію, а тоді натисніть кнопку ОК, щоб увійти в підменю.

Use 24-hour format (Використовувати 24-годинний формат) – натискайте клавіші ▲/▼, щоб вибрати опцію, а тоді натисніть кнопку ОК, щоб вибрати УВІМК./ВИМК.

МОВА

Menu (Меню) ->Settings (Налаштування) ->System (Система) ->Language (Мова)..

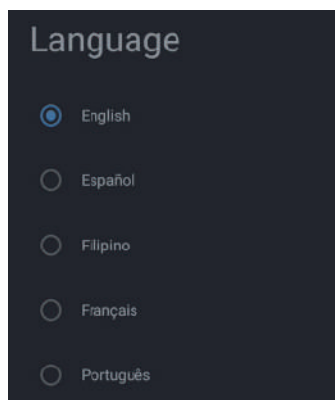

Language (Мова) – натискайте клавіші ▲/▼, щоб вибрати опцію, а тоді натисніть кнопку ОК, щоб увійти в підменю.

ІНСТРУКЦІЯ З ВИКОРИСТАННЯ

КЛАВІАТУРА

Menu (Меню) ->Settings (Налаштування) ->System (Система) -> Keyboard.(Клавіатура)

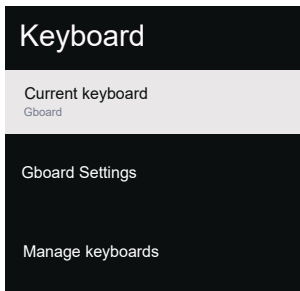

Current keyboard (Поточна клавіатура) – натискайте клавіші ▲/▼, щоб вибрати опцію, а тоді натисніть кнопку ОК, щоб увійти в підменю.
Gboard Settings (Налаштування Gboard) – натискайте клавіші ▲/▼, щоб вибрати опцію, а тоді натисніть кнопку ОК, щоб увійти в підменю.
Manage keyboards (Керування клавіатурами) – натискайте клавіші ▲/▼, щоб вибрати опцію, а тоді натисніть кнопку ОК, щоб увійти в підменю.

ЗБЕРІГАННЯ

Menu (Меню) ->Settings (Налаштування) ->System (Система) ->Storage(Зберігання).

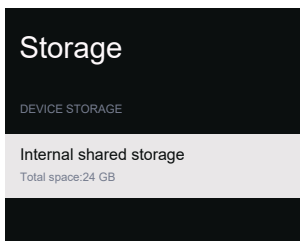

Internal shared storage (Внутрішній носій для зберігання) – натискайте клавіші ▲/▼, щоб вибрати опцію, а тоді натисніть кнопку ОК, щоб увійти в підменю.

AMBIENT MODE (РЕЖИМ ДОВКІЛЛЯ)

Menu (Меню) ->Settings (Налаштування) ->System (Система) -> Ambient mode (Режим довкілля).

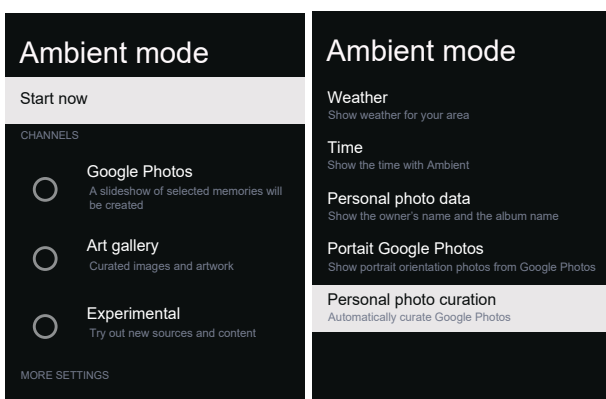

В цьому меню ви можете налаштувати режим довкілля.

1. Натискайте клавіші ▲/▼, щоб вибрати елемент для налаштування.

2. Натисніть кнопку ОК, щоб підтвердити.
3. Після завершення налаштування натисніть кнопку BACK(Назад), щоб повернутися до попереднього меню.

ЖИВЛЕННЯ ТА ЕНЕРГОЗБЕРЕЖЕННЯ

Menu (Меню) ->Settings (Налаштування) ->System (Система) ->Power & Energy.(Живлення та енергозбереження)

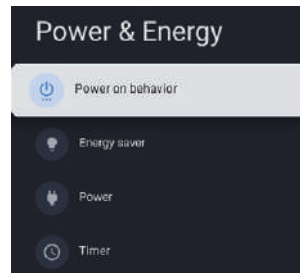

В цьому меню можна налаштувати живлення та енергозбереження.

(живлення, залежно від використання, енергозбереження, таймер живлення)

1. Натискайте кнопку ▲/▼, щоб вибрати елемент для налаштування.
2. Натисніть кнопку ОК, щоб підтвердити.
3. Після завершення налаштування натисніть кнопку BACK(Назад), щоб повернутися до попереднього меню.

ЖИВЛЕННЯ, ЗАЛЕЖНО ВІД ВИКОРИСТАННЯ

Menu (Меню) ->Settings (Налаштування) ->System (Система) ->Power & Energy.(Живлення та енергія) ->Power on behavior (Живлення, залежно від використання).

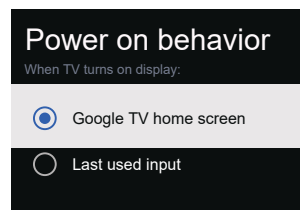

Натискайте клавіші ▲/▼, щоб вибрати елемент для налаштування, а тоді натисніть кнопку ОК для підтвердження.

ЕНЕРГОЗБЕРЕЖЕННЯ

Menu (Меню) ->Settings (Налаштування) ->System (Система) ->Power & Energy.(Живлення та енергозбереження) ->Energy saver.(Енергозбереження).

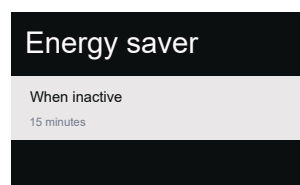

ІНСТРУКЦІЯ З ВИКОРИСТАННЯ

When inactive (коли неактивний) – натискайте клавіші ▲/▼, щоб вибрати опцію, а тоді натисніть кнопку ОК, щоб увійти в підменю.
(Доступні параметри: 15 хвилин, 20 хвилин, 30 хвилин, 1 година, 4 години, 8 годин, 12 годин, 24 години, Ніколи).

ЖИВЛЕННЯ

Menu (Меню) ->Settings (Налаштування) ->System (Система) ->Power & Energy.(Живлення та енергозбереження) ->Power.(Живлення).

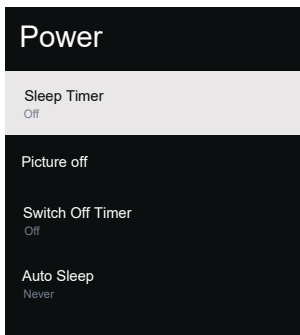

Sleep Timer (Таймер сну) – натискайте клавіші ▲/▼, щоб вибрати опцію, а тоді натисніть кнопку ОК, щоб увійти в підменю.

(Доступні параметри: off (Вимк.), 10 minutes, 20 minutes, 30 minutes, 40 minutes, 50 minutes, 60 minutes, 90 minutes, 120 minutes)

Picture off (Зображення вимк.) – натискайте клавіші ▲/▼, щоб вибрати опцію, а тоді натисніть кнопку ОК, щоб увійти в підменю.

Switch off timer (Вимкнути таймер) – натискайте клавіші ▲/▼, щоб вибрати опцію, а тоді натисніть кнопку ОК, щоб увійти в підменю.

(Доступні параметри: off (Вимк.), 30 minutes, 60 minutes, 90 minutes, 120 minutes, 150 minutes, 180 minutes, 210 minutes, 240 minutes)

Auto Sleep (Автоматичний сон) – натискайте клавіші ▲/▼, щоб вибрати опцію, а тоді натисніть кнопку ОК, щоб увійти в підменю.

(Доступні параметри: Never (Ніколи), 4 hours (4 години), 6 hours (6 годин) 8 hours (8 годин))

ТАЙМЕР

Menu (Меню) ->Settings (Налаштування) ->System (Система) ->Power & Energy.(Живлення та енергозбереження) -> Timer (Таймер).

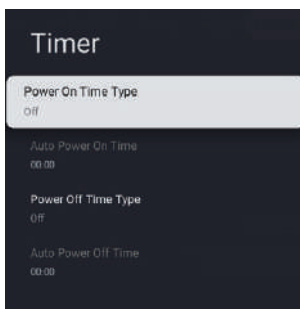

Power On Time Type (Тип увімкнення за часом) – натискайте клавіші ▲/▼, щоб вибрати опцію, а тоді натисніть кнопку ОК, щоб вибрати ВИМК./УВИМК./ОДИН РАЗ.

Auto Power On Time (Автоматичне увімкнення за часом) – натискайте клавіші ▲/▼, щоб вибрати опцію, а тоді натисніть кнопку ОК, щоб увійти в підменю.

Power Off Time Type (Тип вимкнення за часом) – натискайте клавіші ▲/▼, щоб вибрати опцію, а тоді натисніть кнопку ОК, щоб вибрати ВИМК./УВИМК./ОДИН РАЗ.

Auto Power Off Time (Автоматичне вимкнення за часом) – натискайте клавіші ▲/▼, щоб вибрати опцію, а тоді натисніть кнопку ОК, щоб увійти в підменю.

ТРАНСЛЯЦІЯ ЕКРАНА

Menu (Меню) ->Settings (Налаштування) ->System (Система) -> Cast (Трансляція екрана).

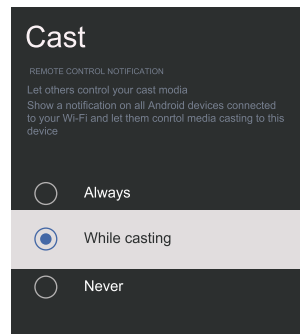

1. Натискайте кнопку ▲/▼, щоб вибрати елемент для налаштування.
2. Натисніть кнопку ОК, щоб підтвердити.
3. Натисніть кнопку BACK (Назад) для повернення до попереднього меню.

ДЕМОНСТРАЦІЙНИЙ РЕЖИМ

Menu (Меню) ->Settings (Налаштування) ->System (Система) -> Retail Mode (Демонстраційний режим).

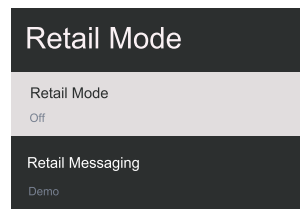

Retail mode (Демонстраційний режим) – натискайте клавіші ▲/▼, щоб вибрати опцію, а тоді натисніть кнопку ОК, щоб вибрати УВИМК./ВИМК.

Retail messaging (Демонстраційні повідомлення) – натискайте клавіші ▲/▼, щоб вибрати опцію, а тоді натисніть кнопку ОК, щоб увійти в підменю.
(Примітка: Demo (Демонстраційний), e-POP, e-POP + Demo (e-POP + демонстраційний))

ІНСТРУКЦІЯ З ВИКОРИСТАННЯ

ПЕРЕЗАПУСК

Menu (Меню) ->Settings (Налаштування) ->System (Система) -> Restart (Перезапуск).

Натисніть кнопку **ОК**, щоб підтвердити увійти в підменю.

(Доступні параметри: restart (перезапустити) та cancel (скасувати))

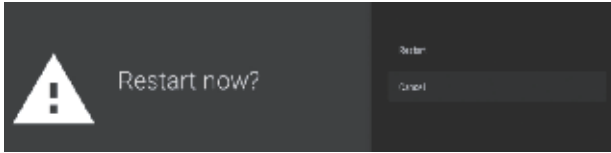

ПУЛЬТИ ДИСТАНЦІЙНОГО КЕРУВАННЯ ТА АКСЕСУАРИ

Menu (Меню) ->Settings (Налаштування) -> Remotes & Accessories (Пульты дистанційного керування та аксесуари).

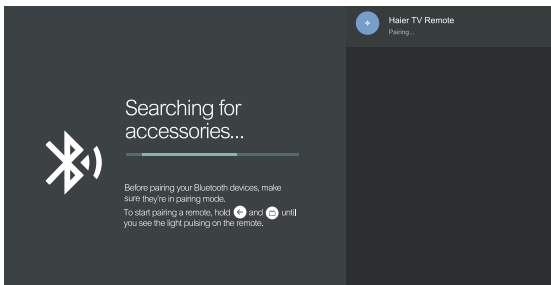
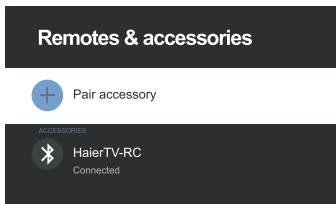

В цьому меню ви можете створювати пари з Bluetooth-пристроями.

1. Натисніть одночасно клавіші "←" та "📺" внизу пульта дистанційного керування та утримуйте 5 секунд.
2. Коли LED-індикатор почне блимати, відпустіть їх. Пульт дистанційного керування надішле сигнал створення пари на телевізор та відобразить інформацію про пульт дистанційного керування на правій стороні екрана.
3. Натисніть кнопку **ОК** для відображення створення пари. Якщо відобразиться «Paired» (Пару створено), тоді з'єднання успішне!
4. Якщо відобразиться «Couldn't pair» (Неможливо створити пару), тоді з'єднання не відбулося. Зачекайте 30 секунд, а тоді натисніть одночасно клавіші "←" and "📺" внизу пульта дистанційного керування та утримуйте 5 секунд, щоб повторити попередні кроки.

5. Натисніть клавішу "←", щоб повернутися до попереднього меню.

ВИКОРИСТАННЯ МУЛЬТИМЕДІЙНОГО ПРОГРАВАЧА

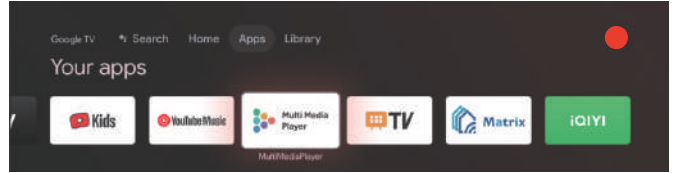

1. На сторінці HOME (Головна) або APPS (Застосунки) **натискайте** ▲/▼/◀/▶, щоб вибрати застосунок Multi Media Player.

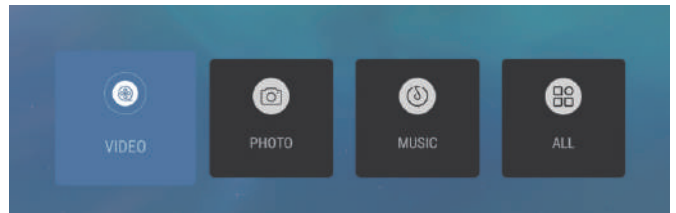

2. Виберіть клавішу ОК, щоб увійти в Multi Media Player (Мультимедійний програвач) та відобразити опції Video (Відео), Photo (Знімки), Audio (Аудіо). Вставивши usb-носіє, ви можете переглянути файли, що зберігаються на ньому (Формат FAT32).

ПРИМІТКА

Меню може відрізнитися залежно від того, коли був придбаний телевізор.

УСУНЕННЯ НЕСПРАВНОСТЕЙ

Перед тим як звернутися в сервісний центр, виконайте такі прості перевірки. Це поради можуть зекономити ваш час та кошти, оскільки плата за встановлення ресивера та здійснення налаштувань не покривається гарантією.

Симптоми	Що перевірити, та які дії виконати
«Фантомне» зображення або двоїння зображення	<ul style="list-style-type: none">Це можуть спричинювати перешкоди, що знаходяться навпроти антени, наприклад, високі будівлі або пагорби. Використання направленої антени може покращити зображення.
Відсутнє живлення	<ul style="list-style-type: none">Перевірте, чи шнур живлення телевізора підключений до електричної розетки.Відключіть телевізор від електричної розетки на 60 секунд. Після цього знову підключіть штепсельну вилку до електричної розетки та увімкніть телевізор знову.
Відсутнє зображення	<ul style="list-style-type: none">Перевірте підключення антени на задній панелі телевізора, чи вона налжено підключена до телевізора.Можливі проблеми з трансляванням каналу. Спробуйте інший канал.Налаштуйте контрастність та яскравість.Перевірте список закритих субтитрів. Деякі ТЕКСТОВІ режими можуть блокувати екран.
Хороше зображення, але відсутній звук.	<ul style="list-style-type: none">Натисніть клавішу MUTE (Приглушити) на пульті дистанційного керування, щоб упевнитись, що функція приглушення звуку вимкнена.
Хороший звук, але поганий колір.	<ul style="list-style-type: none">Налаштуйте контрастність, колір та налаштування яскравості.
Погане зображення.	<ul style="list-style-type: none">Погана якість зображення може виникати, коли до телевізора одночасно підключена S-VHS камера або відеокамера одночасно з іншими периферійними пристроями. Вимкніть один із периферійних пристроїв.
Шум та «сніжить» зображення	<ul style="list-style-type: none">Перевірте підключення антени.
Горизонтальна крапкова лінія.	<ul style="list-style-type: none">Може виникати внаслідок електричних перешкод (наприклад від сушарки для волосся, неонового освітлення поблизу тощо). Вимкніть прилади, що створюють перешкоди.
Телевізор не відповідає на пульт дистанційного керування	<ul style="list-style-type: none">Перевірте, чи батарейки в пульті дистанційного керування працюють. Замініть за необхідності.Почистіть об'єктив датчика дистанційного керування на телевізорі.
На екрані присутні пікселі (крапки), які завжди темні або завжди світяться.	<ul style="list-style-type: none">Ваш телевізор це продукт високоточного виробництва з використанням надзвичайно високих рівнів технології. Однак інколи пікселі можуть відтворювати зображення неправильно. Такі випадки властиві для цього типу виробу та не вважаються дефектами виробу.

ПРИМІТКА

- Цей виріб використовує панель, що складається з субпікселів, виробництво яких вимагає застосування складних технологій. Незважаючи на це, на екрані можуть бути присутні кілька яскравих або темних пікселів. Ці пікселі не матимуть жодного впливу на роботу цього виробу.



Терміни HDMI, HDMI High-Definition Multimedia Interface, HDMI Trade dress та логотипи HDMI є торговими марками або зареєстрованими торговими марками корпорації HDMI Licensing Administrator, Inc.



Dolby, Dolby Vision, Dolby Atmos, Dolby Audio та значок із подвійним D є торговими марками корпорації Dolby Laboratories Licensing Corporation. Виготовлено за ліцензією від Dolby Laboratories. Конфіденційні неопубліковані матеріали. Авторське право ©2012-2024 Dolby Laboratories. Авторські права захищено

ТЕХНІЧНІ ХАРАКТЕРИСТИКИ ВИРОБУ

43" UHD LED Телевізор

Якість зображення телевізора:	UHD Інтегрований цифровий Розмір екрана: 108 см Роздільна здатність 3840 x 2160 пікселів 60 Гц
Система телевізора:	PAL-B/G, SECAM-B/G
DTV декодер тюнера	DVB-T, DVB-C, DVB-T2, DVB-S2 16/32/64/128/256 QAM модуляція MPEG2, MPEG4, H.265
Підключення:	1 Оптичний роз'єм 2 USB-роз'єми 1 LAN 4 HDMI-роз'єми 1 VIDEO-роз'єм 1 L-роз'єм 1 R-роз'єм 2 RF-роз'єми 1 Гніздо для навушників 1 CI слот Підтримувані системи: PAL+SECAM Число каналів для збереження 1000(DTV), 100(ATV) TV (RF): 75Ω Дисбаланс AV Відеовхід: 75 Ω, 1V-P, RCA AV Аудіовхід: 20KΩ, 500 мВ RMS HDMI Відеовхід: 480i, 480p, 720p, 1080i, 1080p, 2160p WiFi: Стандарт: IEEE 802.11a/b/g/n/ac, Частота: 2,4 Гц/5 Гц. Bluetooth: V5.1
Якість звуку:	Стереозвукова система. Потужність виходу 2 x 10 Вт RMS.
Енергоспоживання в режимі очікування	≤ 0,5 Вт
Цифрові функції:	Цифрова інтерактивність. Цифровий текст. Цифрове відеомовлення (DVB) з доступними субтитрами. Автоналаштування. Автосканування нових каналів. Поточна та майбутня програма передач. Електронна програма передач (ЕПП) на 7 днів. Гнізда CI. Підтримка аудіоопису.
Додаткові функції:	UHF/VHF тюнер; таймер сну; батьківський контроль; Зображення та текст Для пульта дистанційного керування потрібні: батарейки 2 x AAA. Розмір кріплення: 300 x 300 мм Розмір упаковки (Ш x В x Д): 1075 x 652 x 142 мм Розмір телевізора з підставкою (Ш x В x Д): 957,2 x 607,4 x 240,7 мм Розмір телевізора без підставки (Ш x В x Д): 957,2 x 566,7 x 86,6 мм Вага в упаковці: 10 кг Вага телевізора з підставкою: 7,2 кг Вага телевізора без підставки: 6,8 кг

* Технічні характеристики деталей цього телевізора наведені тут тільки для довідки. Можуть траплятися відмінності, оскільки технологія виробу оновлюється. Дизайн та технічні характеристики можуть бути змінені без попередження.

ТЕХНІЧНІ ХАРАКТЕРИСТИКИ ВИРОБУ

50" UHD LED Телевізор

Якість зображення телевізора:	UHD Інтегрований цифровий Розмір екрана: 126 см Роздільна здатність 3840 x 2160 пікселів 60 Гц
Система телевізора:	PAL-B/G, SECAM-B/G
DTV декодер тюнера	DVB-T, DVB-C, DVB-T2, DVB-S2 16/32/64/128/256 QAM модуляція MPEG2, MPEG4, H.265
Підключення:	1 Оптичний роз'єм 2 USB-роз'єми 1 LAN 4 HDMI-роз'єми 1 VIDEO-роз'єм 1 L-роз'єм 1 R-роз'єм 2 RF-роз'єми 1 Гніздо для навушників 1 CI слот Підтримувані системи: PAL+SECAM Число каналів для збереження 1000(DTV), 100(ATV) TV (RF): 75 Ω дисбаланс AV Відеовхід: 75 Ω, 1V-P, RCA AV Аудіовхід: 20KΩ, 500 мВ RMS HDMI відеовхід: 480i, 480p, 720p, 1080i, 1080p, 2160p WiFi: Стандарт: IEEE 802.11a/b/g/n/ac, Частота: 2,4 ГГц/5 ГГц. Bluetooth: V5.1
Якість звуку:	Стереозвукова система. Потужність виходу 2 x 13.5 Вт RMS.
Енергоспоживання в режимі очікування	≤ 0,5 Вт
Цифрові функції:	Цифрова інтерактивність. Цифровий текст. Цифрове відеомовлення (DVB) з доступними субтитрами. Автоналаштування. Автосканування нових каналів. Поточна та майбутня програма передач. Електронна програма передач (ЕПП) на 7 днів. Гнізда CI. Підтримка аудіоопису.
Додаткові функції:	UHF/VHF тюнер; таймер сну; батьківський контроль; Зображення та текст Для пульта дистанційного керування потрібні: батарейки 2 x AAA. Розмір кріплення: 300 x 300 мм Розмір упаковки (Ш x В x Д): 1250 x 760 x 144 мм Розмір телевізора з підставкою (Ш x В x Д): 1111,2 x 710,5 x 277,2 мм Розмір телевізора без підставки (Ш x В x Д): 1111,2 x 651,8 x 88 мм Вага в упаковці: 13,5 кг Вага телевізора з підставкою: 10 кг Вага телевізора без підставки: 9,5 кг

* Технічні характеристики деталей цього телевізора наведені тут тільки для довідки. Можуть траплятися відмінності, оскільки технологія виробу оновлюється. Дизайн та технічні характеристики можуть бути змінені без попередження.

ТЕХНІЧНІ ХАРАКТЕРИСТИКИ ВИРОБУ

55" UHD LED Телевізор

Якість зображення телевізора:	UHD Інтегрований цифровий Розмір екрана: 139 см Роздільна здатність 3840 x 2160 пікселів 60 Гц
Система телевізора:	PAL-B/G, SECAM-B/G
DTV декодер тюнера	DVB-T, DVB-C, DVB-T2, DVB-S2 16/32/64/128/256 QAM модуляція MPEG2, MPEG4, H.265
Підключення:	1 Оптичний роз'єм 2 USB-роз'єми 1 LAN 4 HDMI-роз'єми 1 VIDEO-роз'єм 1 L-роз'єм 1 R-роз'єм 2 RF-роз'єми 1 Гніздо для навушників 1 CI слот Підтримувані системи: PAL+SECAM Число каналів для збереження 1000(DTV), 100(ATV) TV (RF): 75Ω Дисбаланс AV Відеовхід: 75 Ω, 1V-P, RCA AV Аудіовхід: 20KΩ, 500 мВ RMS HDMI Відеовхід: 480i, 480p, 720p, 1080i, 1080p, 2160p WiFi: Стандарт: IEEE 802.11 a/b/g/n/ac, Частота: 2,4 Гц/5 Гц. Bluetooth: V5.1
Якість звуку:	Стереозвукова система. Потужність виходу 2 x 13,5 Вт RMS.
Енергоспоживання в режимі очікування	≤ 0,5 Вт
Цифрові функції:	Цифрова інтерактивність. Цифровий текст. Цифрове відеомовлення (DVB) з доступними субтитрами. Автоналаштування. Автосканування нових каналів. Поточна та майбутня програма передач. Електронна програма передач (ЕПП) на 7 днів. Гнізда CI. Підтримка аудіоопису.
Додаткові функції:	UHF/VHF тюнер; таймер сну; батьківський контроль; Зображення та текст Для пульта дистанційного керування потрібні: батарейки 2 x AAA. Розмір кріплення: 300 x 300 мм Розмір упаковки (Ш x В x Д): 1350 x 837 x 144 мм Розмір телевізора з підставкою (Ш x В x Д): 1225,8 x 777,3 x 277,2 мм Розмір телевізора без підставки (Ш x В x Д): 1225,8 x 719,4 x 88,1 мм Вага в упаковці: 16,4 кг Вага телевізора з підставкою: 11,9 кг Вага телевізора без підставки: 11,4 кг

* Технічні характеристики деталей цього телевізора наведені тут тільки для довідки. Можуть траплятися відмінності, оскільки технологія виробу оновлюється. Дизайн та технічні характеристики можуть бути змінені без попередження.

ТЕХНІЧНІ ХАРАКТЕРИСТИКИ ВИРОБУ

65" UHD LED Телевізор

Якість зображення телевізора:	UHD Інтегрований цифровий Розмір екрана: 164 см Роздільна здатність 3840 x 2160 пікселів 60 Гц
Система телевізора:	PAL-B/G, SECAM-B/G
DTV декодер тюнера	DVB-T, DVB-C, DVB-T2, DVB-S2 16/32/64/128/256 QAM модуляція MPEG2, MPEG4, H.265
Підключення:	1 Оптичний роз'єм 2 USB-роз'єми 1 LAN 4 HDMI-роз'єми 1 VIDEO-роз'єм 1 L-роз'єм 1 R-роз'єм 2 RF-роз'єми 1 Гніздо для навушників 1 CI слот Підтримувані системи: PAL+SECAM Число каналів для збереження 1000(DTV), 100(ATV) TV (RF): 75 Ω дисбаланс AV Відеовхід: 75 Ω, 1V-P, RCA AV Аудіовхід: 20KΩ, 500 мВ RMS HDMI відеовхід: 480i, 480p, 720p, 1080i, 1080p, 2160p WiFi: Стандарт: IEEE 802.11a/b/g/n/ac, Частота: 2,4 Гц/5 Гц. Bluetooth: V5.1
Якість звуку:	Стереозвукова система. Потужність виходу 2 x 13,5 Вт RMS.
Енергоспоживання в режимі очікування	≤ 0,5 Вт
Цифрові функції:	Цифрова інтерактивність. Цифровий текст. Цифрове відеомовлення (DVB) з доступними субтитрами. Автоналаштування. Автосканування нових каналів. Поточна та майбутня програма передач. Електронна програма передач (ЕПП) на 7 днів. Гнізда CI. Підтримка аудіоопису.
Додаткові функції:	UHF/VHF тюнер; таймер сну; батьківський контроль; Зображення та текст Для пульта дистанційного керування потрібні: батарейки 2 x AAA. Розмір кріплення: 400 x 300 мм Розмір упаковки (Ш x В x Д): 1600 x 960 x 164 мм Розмір телевізора з підставкою (Ш x В x Д): 1446,4 x 904,7 x 313,8 мм Розмір телевізора без підставки (Ш x В x Д): 1446,4 x 841,3 x 85,1 мм Вага в упаковці: 24 кг Вага телевізора з підставкою: 17,2 кг Вага телевізора без підставки: 16,5 кг

* Технічні характеристики деталей цього телевізора наведені тут тільки для довідки. Можуть траплятися відмінності, оскільки технологія виробу оновлюється. Дизайн та технічні характеристики можуть бути змінені без попередження.

Haier