

Wireless Stereo Headset
WF-C500



Model: YY2952

Use this manual if you encounter any problems, or have any questions.

Update the software of the headset and “Sony | Headphones Connect” app to the latest version. For details, refer to the following:

<https://www.sony.net/elesupport/>

Getting started

[What you can do with the BLUETOOTH® function](#)

[About the voice guidance](#)

Supplied accessories

[Checking the package contents](#)

[Replacing the earbud tips](#)

[When you have finished using the headset](#)

Parts and controls

[Location and function of parts](#)

[About the indicator](#)

Wearing the headset

- [Wearing the headset](#)
- [Using only one unit of the headset](#)

Power/Charging

- [Charging](#)
- [Available operating time](#)
- [Checking the remaining battery charge](#)
- [Turning on the headset](#)
- [Turning off the headset](#)

Making connections

[How to make a wireless connection to Bluetooth devices](#)

Easy setup with app

- [Connecting with the “Sony | Headphones Connect” app](#)

Android smartphone

- [Pairing and connecting with an Android smartphone](#)
- [Connecting to a paired Android smartphone](#)

iPhone (iOS devices)

- [Pairing and connecting with an iPhone](#)
- [Connecting to a paired iPhone](#)

Computers

- [Pairing and connecting with a computer \(Windows® 10\)](#)
- [Pairing and connecting with a computer \(Windows 8.1\)](#)
- [Pairing and connecting with a computer \(Mac\)](#)
- [Connecting to a paired computer \(Windows 10\)](#)
- [Connecting to a paired computer \(Windows 8.1\)](#)
- [Connecting to a paired computer \(Mac\)](#)

Other Bluetooth devices

- [Pairing and connecting with a Bluetooth device](#)
- [Connecting to a paired Bluetooth device](#)

Listening to music

Listening to music via a Bluetooth connection

[Listening to music from a device via Bluetooth connection](#)

[Controlling the audio device \(Bluetooth connection\)](#)

[Disconnecting Bluetooth connection \(after use\)](#)

Sound quality mode

[About the sound quality mode](#)

[Supported codecs](#)

[About the DSEE function](#)

Making phone calls

[Receiving a call](#)

[Making a call](#)

[Functions for a phone call](#)

[Making a video call on your computer](#)

[Disconnecting Bluetooth connection \(after use\)](#)

Using the voice assist function

[Using the voice assist function \(Google app\)](#)

[Using the voice assist function \(Siri\)](#)

Using the apps

[What you can do with the “Sony | Headphones Connect” app](#)

[Installing the “Sony | Headphones Connect” app](#)

[Accessing support information from the “Sony | Headphones Connect” app](#)

[How to keep the software up-to-date \(for comfortable use of the headset\)](#)

Important information

[Precautions](#)

[To prevent burning or malfunction due to getting wet](#)

[When the headset or charging case gets wet](#)

[License notice](#)

[Trademarks](#)

[Customer support websites](#)

Troubleshooting

[What can I do to solve a problem?](#)

Power/Charging

- [Unable to turn on the headset.](#)
- [Charging cannot be done.](#)
- [The available operating time is short, the battery power does not last long.](#)
- [Charging time is too long.](#)

Sound

- [No sound, no sound from one side](#)
- [Low sound level](#)
- [Low sound quality](#)
- [Sound skips frequently.](#)
- [Noise is heard during music playback.](#)

Bluetooth connection

- [Pairing cannot be done.](#)
- [Unable to make a Bluetooth connection.](#)
- [The headset does not operate properly.](#)
- [Cannot hear a person during a call/low voice from callers, your voice does not reach the person during a call/your voice is low on the caller's side.](#)

Others

- [Earbud tips are damaged or lost.](#)
- [An earache occurs](#)

Resetting or initializing the headset

- [Resetting the headset](#)
- [Initializing the headset to restore factory settings](#)

Specifications

[Specifications](#)

Wireless Stereo Headset
WF-C500

What you can do with the BLUETOOTH® function

The headset uses Bluetooth wireless technology, allowing you to do the following.

Listening to music

You can receive audio signals from a smartphone or music player to enjoy music wirelessly.



Talking on the phone

You can make and receive calls hands-free, while leaving your smartphone or mobile phone in your bag or pocket.

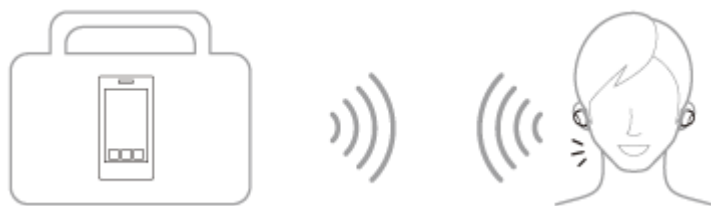

Wireless Stereo Headset
WF-C500

About the voice guidance

In the factory settings, you will hear the English voice guidance via the headset.

You can change the language of the voice guidance and turn on/off the voice guidance using “Sony | Headphones Connect” app. For more details, refer to the “Sony | Headphones Connect” app help guide.

https://rd1.sony.net/help/mdr/hpc/h_zz/

You will hear a voice guidance from the left and right units of the headset at the same time in the following situations.

- When entering pairing mode: “Bluetooth pairing”

You will hear a voice guidance from the left and right units of the headset in the following situations. When you remove only one unit of the headset from the charging case and use it, you will hear a voice guidance from the unit you are using.

- When the headset unit is removed from the charging case and turned on: “Power on”
- When powering off with the “Sony | Headphones Connect” app/When automatically turning off 15 minutes after disconnecting a Bluetooth connection: “Power off”
- When informing the remaining battery charge of the headset: “Battery about XX %” (The “XX” value indicates the approximate remaining charge. Use it as a rough estimate.) / “Battery fully charged”
- When the remaining battery charge of the headset is low: “Low battery, please recharge headset”
- When automatically turning off due to low battery of the headset: “Please recharge headset. Power off”

You will hear a voice guidance from the unit of the headset that was removed first from the charging case in the following situations.

- When establishing a Bluetooth connection: “Bluetooth connected”
- When disconnecting a Bluetooth connection: “Bluetooth disconnected”

Note

- It takes up to about 6 minutes when you change the language of the voice guidance.
- When you initialize the headset to restore to the factory settings after you change the language of the voice guidance, the language will not return to the factory settings.
- If the voice guidance is not heard after changing the voice guidance language or updating the software of the headset, set the headset into the charging case to turn it off, then remove the headset from the charging case to turn it on again.

Related Topic

- [Using only one unit of the headset](#)

Wireless Stereo Headset
WF-C500

Checking the package contents

After opening the package, check that all of the items in the list are included. If any items are missing, contact your dealer.

Numbers in () indicate the item amount.

Wireless Stereo Headset

USB Type-C® cable (USB-A to USB-C®) (approx. 20 cm (7.88 in.)) (1)



Hybrid silicone rubber earbud tips (SS/M/LL 2 each)

- M-sized earbud tips come attached to the left and right units of the headset at the time of purchase. The size of the earbud tips can be determined based on the number of dotted lines inside the bottom of the earbud tips.



SS size: 1 line

M size: 3 lines

LL size: 5 lines

Charging case (1)

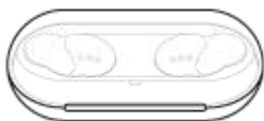

Note

- Earbud tips are consumables. If the earbud tips are damaged and need replacing, contact your nearest Sony dealer or purchase the EP-EX11 series (*) (sold separately).

* May not be supported in some countries or regions.

Replacing the earbud tips

M-sized earbud tips come attached to the left and right units of the headset at the time of purchase.

If the size of the earbud tips does not match the size of your ear canals or the headset is not worn properly in your ears, you may not obtain the correct sound qualities or call performance.

If any of this is the case, try the following.

- Change the earbud tips to ones that fit more snugly in your ears. When changing the earbud tips, try the earbud tip sizes in order from the larger ones to the smaller ones. The size of the left and right earbud tips may be different.
- Check that you are wearing the headset properly in your ears. Wear the headset so that the earbud tip is comfortably situated as deep in the ear canal as possible.

Hybrid silicone rubber earbud tips

The size of the earbud tips can be determined based on the number of dotted lines inside the bottom of the earbud tips.



SS size: 1 line

M size: 3 lines

LL size: 5 lines

1 Remove the earbud tip.

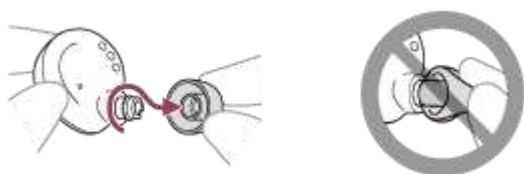

Do not pinch the end of the earbud tip when removing it.

2 Attach the earbud tip.

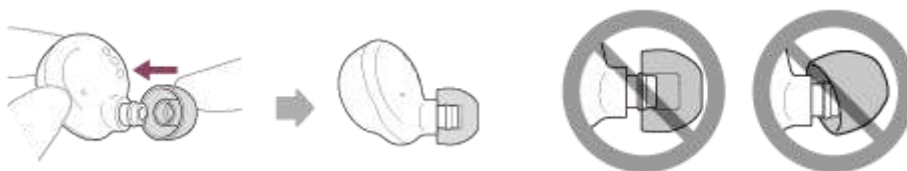

Firmly insert the earbud tip all the way. Do not attach the earbud tip in a loose or skewed manner.

About the instruction manual video

Watch the video to find out how to change the earbud tips and how to wear the headset in your ears.

https://rd1.sony.net/help/mdr/mov0031/h_zz/

Wireless Stereo Headset
WF-C500

When you have finished using the headset

When you have finished using the headset, be sure to set the headset in the charging case. Close the lid of the charging case.



Note

- If perspiration or water is left on the charging port, it may impair the ability to charge the headset. Immediately wipe off any perspiration or water on the charging port after use. When the charging ports of the headset or charging case get dirty, wipe them clean with a soft dry cloth.

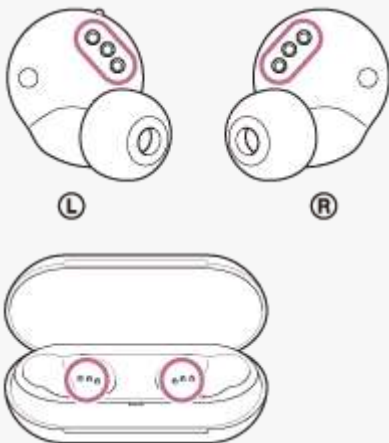

When the headset gets wet

1. Use a soft dry cloth to wipe off any water that gets on the headset.
2. Remove the earbud tips, turn the sound conduits and the air holes downward, and shake several times to get the water out.



3. Turn the microphone hole downward and gently tap it about 5 times on a dry cloth, etc. to remove any water collected inside.



4. Leave the headset to dry in room temperature.

5-030-793-11(2) Copyright 2021 Sony Corporation

Location and function of parts

Headset

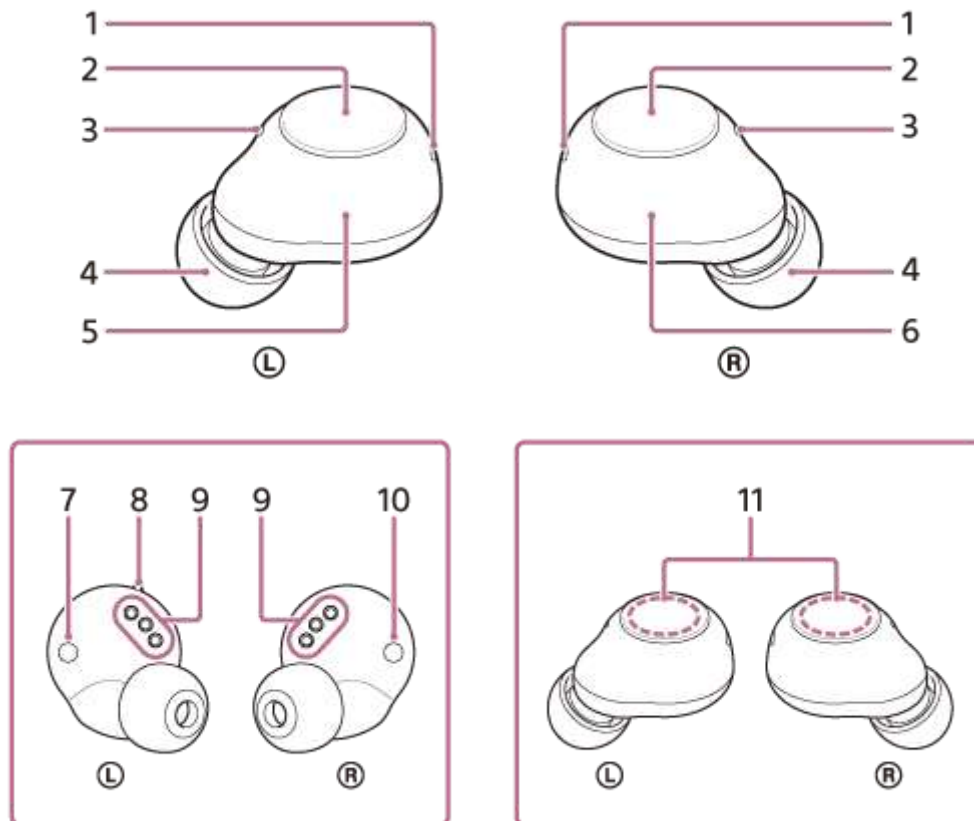

1. Indicators (blue/orange) (left, right)
Lights up in orange while charging.
Lights up in blue or orange to indicate the power or communication status of the headset.
2. Buttons (left, right)
Press to operate the headset.
3. Microphones (left, right)
Picks up the sound of your voice when talking on the phone.
4. Earbud tips (left, right)
5. Left unit of the headset
6. Right unit of the headset
7. Ⓛ (left) mark
8. Tactile dot
There is a tactile dot on the left unit of the headset.
9. Charging ports (left, right)
10. Ⓜ (right) mark
11. Built-in antennas (left, right)
A Bluetooth antenna is built into each left or right unit of the headset.

Charging case

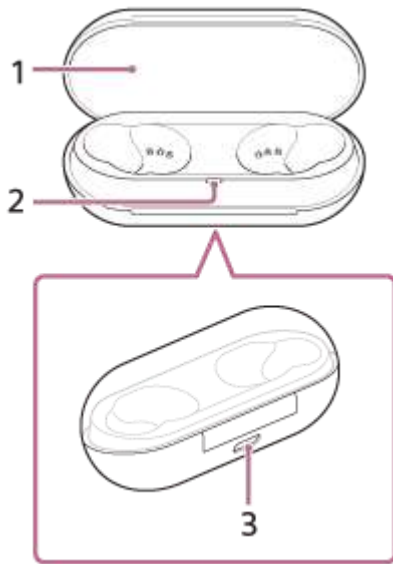

1. Lid
2. Indicator (orange)
Indicates the charging status.
3. USB Type-C port
Using the supplied USB Type-C cable, connect the charging case to a computer or to an AC outlet via a commercially available USB AC adaptor to simultaneously charge both the headset and the charging case.

Related Topic

- [About the indicator](#)
- [Checking the remaining battery charge](#)

Wireless Stereo Headset
WF-C500

About the indicator







You can check various statuses of the headset/charging case by the indicators.

● : Turns on in blue / ● : Turns on in orange / -: Turns off







Power status



- The indicators on the headset
 - When the headset unit is removed from the charging case and turned on
● - ● (flashes twice in blue)
 - When the headset is turned off with the “Sony | Headphones Connect” app / When the headset is automatically turned off after 15 minutes of Bluetooth disconnection / When the battery of the headset becomes empty and the headset turned off
 - - - (lights up in blue for about 2 seconds)

Indication of the remaining battery charge





- The indicators on the headset
 - When the remaining battery charge of the headset is 20% or lower
 -  -  - (repeatedly flashes slowly in orange for about 15 seconds and turns off (the headset needs to be charged))
- The indicator on the charging case
 - When the remaining battery charge of the charging case is 30% or lower and the headset is set to or removed from the charging case
 -  -  - (after the headset is set in or removed from the charging case, repeatedly flashes slowly in orange for about 15 seconds and turns off (the charging case needs to be charged))

Charging status

- The indicators on the headset
 - While charging the headset
 (lights up in orange)
 - When the battery is fully charged when charging starts on the headset
 - - - (lights up in orange for about 1 minute, and then turns off)
 - When the battery becomes fully charged and charging is complete
- - - - - (turns off)
 - Abnormal temperature of the battery of the headset
● ● - - ● ● - - (repeatedly flashes twice in orange)
 - When an error occurs while the headset is charging and the headset is not charged
 - -  - - (repeatedly flashes slowly in orange with an interval of about 0.5 seconds)
- The indicator on the charging case
 - While charging the charging case
 (lights up in orange)
 - When the battery is fully charged when charging starts on the charging case
 - - - (lights up in orange for about 1 minute, and then turns off)
 - When the battery becomes fully charged and charging is complete
- - - - - (turns off)



- Abnormal temperature of the battery of the charging case
 (repeatedly flashes twice in orange)
- When an error occurs while the charging case is charging and the charging case is not charged
 (repeatedly flashes slowly in orange with an interval of about 0.5 seconds)

Bluetooth connection status

- The indicators on the headset
 - Pairing mode
 (repeatedly flashes twice in blue)
 - Not connected
 (repeatedly flashes in blue at about 1-second intervals)
 - Connection process completed
 (repeatedly flashes quickly in blue for about 5 seconds)
 - Connected
 (repeatedly flashes in blue at about 5-second intervals)
 - Incoming call
 (repeatedly flashes quickly in blue)

The unconnected and connected status indications automatically turn off after a period of time has passed. They start flashing again for a period of time when some operation is performed. When the remaining battery charge becomes low, the indicator starts flashing in orange.

Other

- The indicators on the headset
 - Updating software
 (repeatedly flashes slowly in blue)
 - Initialization completed
 (flashes 4 times in blue)
 For details, see [“Initializing the headset to restore factory settings”](#).

Related Topic

- [Charging](#)
- [Checking the remaining battery charge](#)
- [What you can do with the “Sony | Headphones Connect” app](#)
- [Initializing the headset to restore factory settings](#)

Wearing the headset

About the instruction manual video

Watch the video to find out how to change the earbud tips and how to wear the headset in your ears.

https://rd1.sony.net/help/mdr/mov0031/h_zz/

1 Put the headset units into both ears.

Put the headset unit with the **L** (left) mark into your left ear and the headset unit with the **R** (right) mark into your right ear. The left unit has a tactile dot.

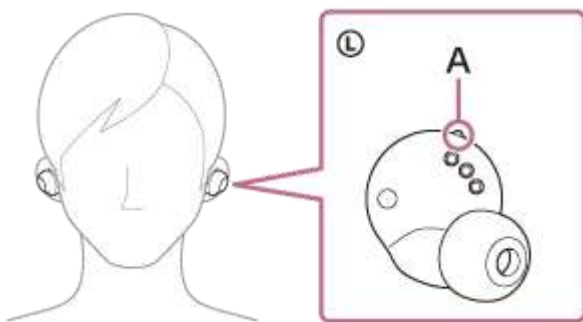

A: Tactile dot

2 Adjust the fit of the headset to your ears.

Twist the headset unit to slide the earbud tip deep into your ear canal.

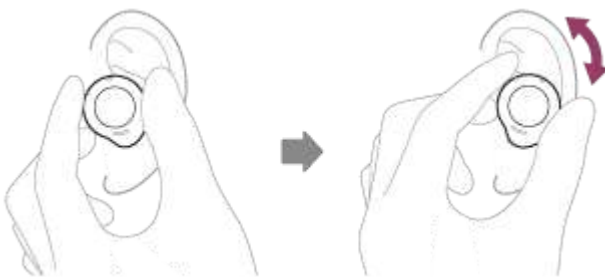

For the proper sound quality, call sound quality, etc. to be effective

If the size of the earbud tips does not match the size of your ear canals or the headset is not worn properly in your ears, you may not obtain the correct sound qualities or call performance.

If any of this is the case, try the following.

- Change the earbud tips to ones that fit more snugly in your ears. When changing the earbud tips, try the earbud tip sizes in order from the larger ones to the smaller ones. The size of the left and right earbud tips may be different.
- See step **2** , check that you are wearing the headset properly in your ears. Wear the headset so that the earbud tip is comfortably situated as deep in the ear canal as possible.

Hint

- You can also play music, make and receive calls, etc. when only one unit of the headset is worn in your ear.

Related Topic

- [Replacing the earbud tips](#)
- [Using only one unit of the headset](#)

5-030-793-11(2) Copyright 2021 Sony Corporation

Using only one unit of the headset

You can remove one unit of the headset from the charging case and use the unit by itself. In this case, only the unit that has been removed from the charging case will turn on.

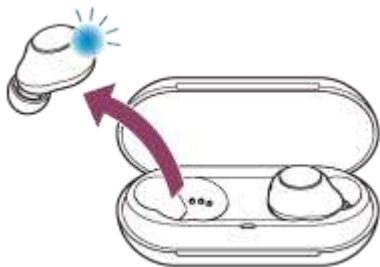

When you remove the other unit of the headset from the charging case

The connection between the left and right units is established automatically, and you will hear the music or other audio on both units of the headset.

Hint

- When listening to music with one ear, if only the right unit is worn in your ear, use the button on the right unit to play music. In this case, adjust the volume on the connected device. When only the left unit is worn in your ear, operate the connected device to play music. In this case, you can adjust the volume with the button on the left unit.
- When you play music or other stereo audio while wearing only one unit, you will hear monaural sound with the left and right channels mixed.
- You can also enjoy hands-free calls even when you are using only one unit of the headset. When you receive an incoming call, answer the call with the unit of the headset you are using. If you remove the other unit of the headset from the charging case while you are talking with only one unit, you can talk with both units.

Note

- When you are using only one unit of the headset, be sure to set the other unit in the charging case.
- When you are using only one unit of the headset, the remaining battery charge of the headset may be different on the left and right sides.

Related Topic

- [Controlling the audio device \(Bluetooth connection\)](#)
- [Functions for a phone call](#)

Charging

The headset and the charging case contain built-in lithium-ion rechargeable batteries. Use the supplied USB Type-C cable to charge the headset before use.

1 Remove the headset from the charging case and remove the insulating sheet.

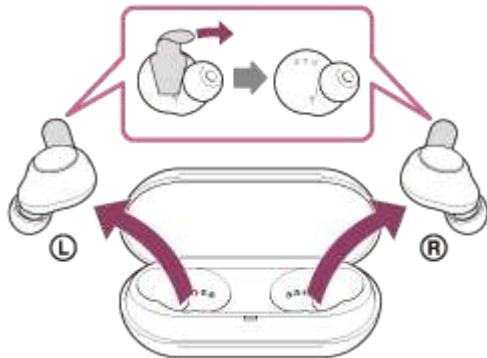

Dispose of the removed insulating sheet.

2 Set the headset into the charging case.

Put the left unit of the headset (the unit with the tactile dot) back into the left hole of the charging case, and put the right unit of the headset back into the right hole of the charging case. Each unit of the headset will be set to the correct position in the charging case by the built-in magnet.

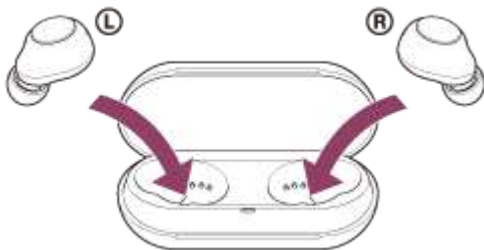

Set the headset into the charging case, and when the indicators (orange) on the headset light up, close the lid of the charging case.

The indicators (orange) on the headset turn off after charging of the headset is complete.

3 Connect the charging case to an AC outlet.

Use the supplied USB Type-C cable and a commercially available USB AC adaptor.

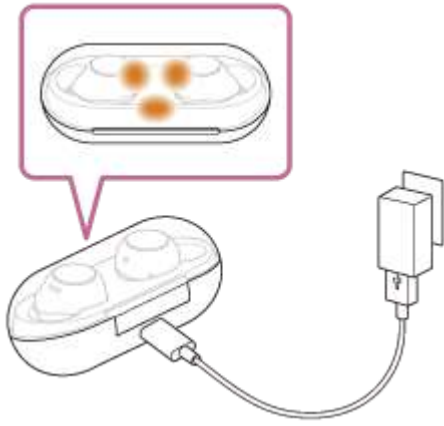

Charging starts on the headset and charging case. The indicators (orange) on the headset and charging case light up.

After charging is complete, the indicators (orange) on the headset and charging case turn off.

Remove the USB Type-C cable.

About the charging time

The required time for fully charging the headset and the charging case is about 3 hours (*).

* Time required for charging the empty battery to its full capacity. The charging time may differ depending on the conditions of use.

Charging the headset when you are outside

A rechargeable battery is built into the charging case. If you charge the charging case in advance, you can use it to charge the headset when you go out without a power supply.

The required time for fully charging the left and right units of the headset is about 2.5 hours.

System requirements for battery charge using USB

USB AC adaptor

A commercially available USB AC adaptor capable of supplying an output current of 0.5 A (500 mA) or more

Personal computer

Personal computer with a standard USB port

- We do not guarantee operation on all computers.
- Operations using a custom-built or homebuilt computer are not guaranteed.

Hint

- The headset can be also charged by connecting the charging case to a running computer using the supplied USB Type-C cable.
- When you remove the headset from the charging case, the voice guidance indicating the remaining battery charge of the headset can be heard via the left and right units of the headset respectively. The remaining battery charge indicated by the voice guidance may differ from the actual remaining charge in some cases. Use it as a rough estimate.

Note

- When removing the insulation sheet after purchase, be sure to set the headset into the charging case and charge the headset before use.
- Be sure to use the supplied USB Type-C cable. Otherwise, charging may not be successful.
- Charging may not be successful depending on the type of USB AC adaptor.
- Depending on the settings for the headset functions and the usage conditions, the speed of energy consumption for the battery may vary between the left and right units.
As a result, the charging time of the batteries may differ between the left and right units, but this is not a malfunction.
- The headset cannot be charged when the computer goes into standby (sleep) or hibernation mode. In this case, change the computer settings, and start charging once again.

- When the headset is placed in the charging case, if the indicator (orange) on the charging case flashes slowly, the remaining battery charge of the charging case is low. Charge the charging case.
- If the indicators (orange) on the headset do not turn on/flash even when the headset is placed in the charging case, the battery charge of the charging case is empty. Charge the charging case.
- If the headset is not used for a long time, the rechargeable battery usage hours may be reduced. However, the battery life will improve after charging and discharging several times. If you store the headset for a long time, charge the battery once every 6 months to avoid over-discharge.
- If the headset is not used for a long time, it may take longer to charge the battery.
- If there is a problem with the rechargeable battery of the headset or the charging case and something unusual is detected during charging, the indicators (orange) on the headset or indicator (orange) on the charging case flash.
It is recommended to charge in a place with an ambient temperature between 15 °C and 35 °C (59 °F - 95 °F). Efficient charging may not be possible beyond this range.
If the problem persists, consult your nearest Sony dealer.
- If the headset is not used for a long time, the indicator (orange) on the charging case may not immediately light up when charging. Wait a moment until the indicator (orange) lights up.
- If the usage hours of the built-in rechargeable battery decrease significantly, the battery should be replaced. Consult your nearest Sony dealer.
- Avoid exposure to extreme temperature changes, direct sunlight, moisture, sand, dust, and electrical shock. Never leave the headset in a parked vehicle.
- When connecting the charging case to a computer, use only the supplied USB Type-C cable, and be sure to directly connect them. Charging will not be properly completed when the charging case is connected through a USB hub.

Related Topic

- [About the indicator](#)
- [About the voice guidance](#)
- [Checking the remaining battery charge](#)

Available operating time

The available operating times of the headset with the battery fully charged are as follows:

Bluetooth connection

Music playback time

Codec	DSEE™	Available operating time
AAC	AUTO	Max. 10 hours
AAC	OFF	Max. 10 hours
SBC	AUTO	Max. 10 hours
SBC	OFF	Max. 10 hours

- About 60 minutes of music playback is possible after 10 minutes charging.
- If you set the following functions, the available operating time of the battery becomes shorter than the ones described above.
 - Equalizer
 - DSEE

If you set the equalizer and DSEE at the same time, the available operating time of the battery becomes even shorter.

Communication time

Max. 5 hours

Hint

- By using the “Sony | Headphones Connect” app, you can check which codec is used for a connection or switch the DSEE function.

Note

- Usage hours may be different from the time described above depending on the settings for the headset functions and usage conditions.
- Depending on the settings for the headset functions and the usage conditions, the speed of energy consumption for the battery may vary between the left and right units, but this is not a malfunction.

Related Topic

- [Supported codecs](#)
- [About the DSEE function](#)
- [What you can do with the “Sony | Headphones Connect” app](#)

Checking the remaining battery charge

You can check the remaining battery charge of the rechargeable batteries of the headset and the charging case.

When you remove the headset from the charging case

When you remove the headset from the charging case, the voice guidance indicating the remaining battery charge of the headset can be heard via the left and right units of the headset respectively.

“Battery about XX %” (The “XX” value indicates the approximate remaining charge.)

“Battery fully charged”

The remaining battery charge indicated by the voice guidance may differ from the actual remaining charge in some cases. Use it as a rough estimate.

When the remaining charge becomes low

If a warning beep sounds and the voice guidance says, “Low battery, please recharge headset”, charge the headset as soon as possible.

When the battery becomes completely empty, a warning beep sounds, the voice guidance says, “Please recharge headset. Power off”, and the headset automatically turns off.

When you are using iPhone or iPod touch

When the headset is connected to an iPhone or iPod touch over an HFP Bluetooth connection, it will show an icon that indicates the remaining battery charge of the headset on the screen of the iPhone or iPod touch.

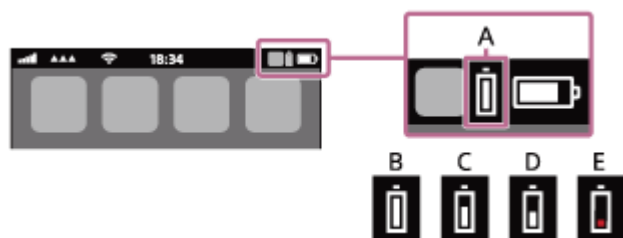

A: Remaining battery charge of the headset

B: 100% - 71%

C: 70% - 51%

D: 50% - 21%

E: 20% or lower (requires charging)

The remaining battery charge of the headset is also displayed on the widget of an iPhone or iPod touch running iOS 11 or later. For more details, refer to the operating instructions supplied with the iPhone or iPod touch.

The remaining charge which is displayed may differ from the actual remaining charge in some cases. Use it as a rough estimate.

When you are using an Android™ smartphone (OS 8.1 or later)

When the headset is connected to an Android smartphone via HFP Bluetooth connection, select [Settings] - [Device connection] - [Bluetooth] to display the remaining battery charge of the headset as 100%, “70%”, “50%” or “20%” in the connected Bluetooth device column on the smartphone’s screen. For details, refer to the operating instructions of the Android smartphone.

The remaining charge which is displayed may differ from the actual remaining charge in some cases. Use it as a rough estimate.

Checking the remaining battery charge of the charging case

- When you set the headset into the charging case or remove the headset from the charging case, if the indicator (orange) on the charging case flashes for about 15 seconds, the remaining battery charge of the charging case is about 30% to 5%. The charging case cannot sufficiently charge the headset with this level of remaining battery charge.
- When you set the headset into the charging case or remove the headset from the charging case, if the indicator (orange) on the charging case does not turn on or turns off immediately, the remaining battery charge of the charging case is less than 5%. The headset cannot be charged with the charging case in this case.

Hint

- The remaining battery charge of the headset may be different on the left and right sides depending on how you use them.
When using both units of the headset, the remaining battery charge of the unit with less remaining battery charge between the left and right units is displayed.
When using only one unit of the headset, the remaining battery charge of the unit you are using is displayed.
- You can also check the remaining battery charge of the headset with the “Sony | Headphones Connect” app. Android smartphones and iPhone/iPod touch both support this app.

Note

- If the headset and smartphone are not connected with HFP, the remaining battery charge will not be correctly displayed.
- The remaining battery charge of the charging case cannot be checked on the “Sony | Headphones Connect” app. When the indicator (orange) on the charging case flashes, charge the charging case.
- The remaining battery charge may not be properly displayed immediately after a software update or if the headset has not been used for a long time. In this case, repeatedly charge and discharge the battery multiple times to properly display the remaining battery charge.

Related Topic

- [What you can do with the “Sony | Headphones Connect” app](#)
- [About the indicator](#)

Turning on the headset

When the headset is set into the charging case

1 Remove the headset from the charging case.

The headset turns on automatically and the indicators (blue) flash.
When you remove only one unit from the charging case, only the removed unit turns on.

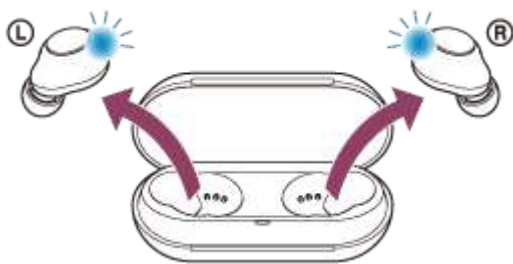

You will hear the voice guidance say, "Power on".

When the headset is not set into the charging case

The headset turns off just after the headset is initialized. In this case, the headset will turn on by pressing and holding the buttons on both units of the headset for about 2 seconds. The headset will also turn on when it is set into the charging case and then removed from the charging case.

When the headset is turned on

When both headset units are removed from the charging case, the connection between the left and right units of the headset is established.

The headset goes into Bluetooth pairing mode when turning on the headset for the first time after purchase or just after initializing the headset.

Related Topic

- [Using only one unit of the headset](#)
- [Turning off the headset](#)

Turning off the headset

1 Set the headset into the charging case.

Put the left unit of the headset (the unit with the tactile dot) back into the left hole of the charging case, and put the right unit of the headset back into the right hole of the charging case. Each unit of the headset will be set to the correct position in the charging case by the built-in magnet.

When the headset is set into the charging case, the headset will turn off automatically.

When the remaining battery charge of the charging case is sufficient, the indicators (orange) on the headset light up and the charging of the headset will start.

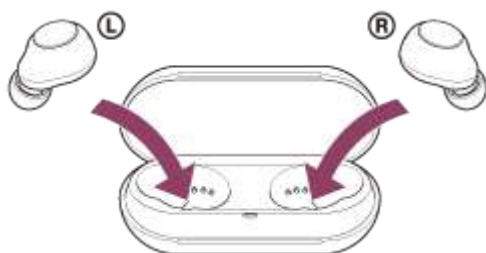

Hint

- You can also turn off the headset with the “Sony | Headphones Connect” app.

Note

- When the remaining battery charge of the charging case is not sufficient, the charging of the headset will not start. Charge the charging case.

Related Topic

- [Charging](#)
- [Turning on the headset](#)
- [What you can do with the “Sony | Headphones Connect” app](#)

Wireless Stereo Headset
WF-C500

How to make a wireless connection to Bluetooth devices

You can enjoy music and hands-free calling with the headset wirelessly by using your Bluetooth device's Bluetooth function.

Pairing

To use the Bluetooth function, both of the connecting devices must be registered in advance. The operation to register a device is called "pairing".

Pair the headset and the device manually.

Connecting to a paired device

Once a device is paired, it is not necessary to pair it again. Connect to devices already paired with the headset using the methods necessary for each device.

Wireless Stereo Headset
WF-C500

Connecting with the “Sony | Headphones Connect” app

Launch the “Sony | Headphones Connect” app on your Android smartphone/iPhone to connect the headset to a smartphone or iPhone. For more details, refer to the “Sony | Headphones Connect” app help guide.

https://rd1.sony.net/help/mdr/hpc/h_zz/



Sony Headphones Connect

Note

- The connection with some smartphones and iPhone devices may become unstable when connecting using the “Sony | Headphones Connect” app. In that case, follow the procedures in “[Connecting to a paired Android smartphone](#)”, or “[Connecting to a paired iPhone](#)” to connect to the headset.

Related Topic

- [Connecting to a paired Android smartphone](#)
- [Connecting to a paired iPhone](#)
- [What you can do with the “Sony | Headphones Connect” app](#)
- [Installing the “Sony | Headphones Connect” app](#)

Pairing and connecting with an Android smartphone

The operation to register the device that you wish to connect to is called “pairing”. First, pair a device to use it with the headset for the first time.

Before starting the operation, make sure of the following:

- The Android smartphone is placed within 1 m (3 feet) of the headset.
- The headset is charged sufficiently.
- The operating instructions of the Android smartphone is in hand.

1 Remove both units of the headset from the charging case.

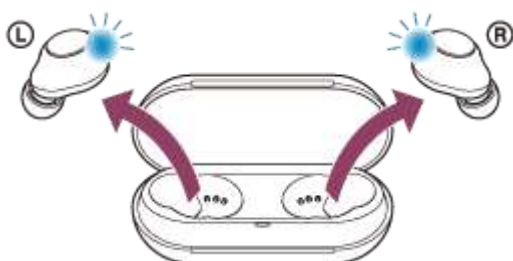

The headset turns on automatically. Check that the indicators (blue) flash.

2 Enter pairing mode on this headset.

When you pair the headset with a device for the first time after purchase or after initializing the headset (if the headset has no pairing information), the headset enters pairing mode automatically if you remove the headset from the charging case. In this case, proceed to step 3 .

When you pair a second or subsequent device (the headset has pairing information for other devices), press and hold the buttons on both the left and right units for about 5 seconds.

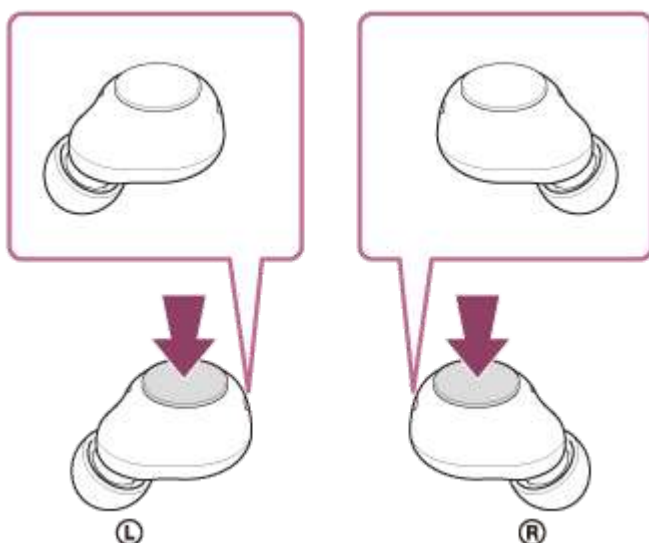

Check that the indicator (blue) on both units of the headset repeatedly flashes twice in a row. You will hear the voice guidance say “Bluetooth pairing”, from both headset units at the same time.

3 Unlock the screen of the Android smartphone if it is locked.

4 Find the headset on the Android smartphone.

1. Select [Settings] - [Device connection] - [Bluetooth].



2. Touch the switch to turn on the Bluetooth function.



5 Touch [WF-C500].



If Passkey (*) input is required, input "0000".

The headset and smartphone are paired and connected with each other.

The indicators (blue) on both units of the headset flash quickly for about 5 seconds.

You will hear the voice guidance say "Bluetooth connected" from the unit of the headset that was removed first from the charging case.

If they are not connected, see "[Connecting to a paired Android smartphone](#)".

If [WF-C500] does not appear on the Android smartphone screen, try again from the beginning of step 4 .

* A Passkey may be called "Passcode", "PIN code", "PIN number", or "Password".

About the instruction manual video

Watch the video to find out how to perform the pairing for the first time.

https://rd1.sony.net/help/mdr/mov0028/h_zz/

Hint

- The operation above is an example. For more details, refer to the operating instructions supplied with the Android smartphone.
- To delete all Bluetooth pairing information, see "[Initializing the headset to restore factory settings](#)".

Note

- If pairing is not established within 5 minutes, pairing mode is canceled. In this case, set the headset into the charging case, and start the operation again from step 1 .

- Once Bluetooth devices are paired, there is no need to pair them again, except in the following cases:
 - Pairing information has been deleted after repair, etc.
 - When a 9th device is paired.
The headset can be paired with up to 8 devices. If a new device is paired after 8 devices are already paired, the registration information of the paired device with the oldest connection date is overwritten with the information for the new device.
 - When the pairing information for the headset has been deleted from the Bluetooth device.
 - When the headset is initialized.
All of the pairing information is deleted. In this case, delete the pairing information for the headset from the connected device and then pair them again.
- The headset can be paired with multiple devices, but can only play music from 1 paired device at a time.

Related Topic

- [Wearing the headset](#)
- [How to make a wireless connection to Bluetooth devices](#)
- [Connecting to a paired Android smartphone](#)
- [Listening to music from a device via Bluetooth connection](#)
- [Disconnecting Bluetooth connection \(after use\)](#)
- [Initializing the headset to restore factory settings](#)

Connecting to a paired Android smartphone

1 Unlock the screen of the Android smartphone if it is locked.

2 Remove the headset from the charging case.

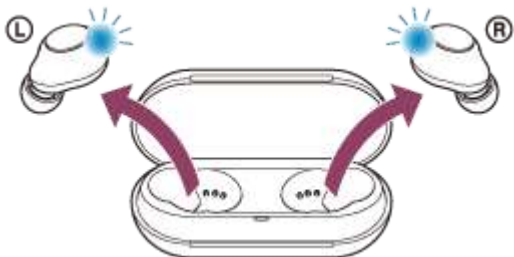

The headset turns on automatically. Check that the indicators (blue) flash.

If the headset has automatically connected to the last connected device, you will hear the voice guidance say “Bluetooth connected” from the unit of the headset that was removed first from the charging case.

Check the connection status on the Android smartphone. If it is not connected, proceed to step 3 .

3 Display the devices paired with the Android smartphone.

1. Select [Settings] - [Device connection] - [Bluetooth].



2. Touch the switch to turn on the Bluetooth function.



4 Touch [WF-C500].



You will hear the voice guidance say “Bluetooth connected” from the unit of the headset that was removed first from the charging case.

Hint

- The operation above is an example. For more details, refer to the operating instructions supplied with the Android smartphone.

Note

- If the last-connected Bluetooth device is placed near the headset, the headset may connect automatically to the device by simply turning on the headset. If this is the case, deactivate the Bluetooth function on the last-connected device or turn off the power.
- If you cannot connect your smartphone to the headset, delete the headset pairing information on your smartphone and perform the pairing again. As for the operations on your smartphone, refer to the operating instructions supplied with the smartphone.

Related Topic

- [Wearing the headset](#)
- [Using only one unit of the headset](#)
- [How to make a wireless connection to Bluetooth devices](#)
- [Pairing and connecting with an Android smartphone](#)
- [Listening to music from a device via Bluetooth connection](#)
- [Disconnecting Bluetooth connection \(after use\)](#)

Pairing and connecting with an iPhone

The operation to register the device that you wish to connect to is called “pairing”. First, pair a device to use it with the headset for the first time.

Before starting the operation, make sure of the following:

- The iPhone is placed within 1 m (3 feet) of the headset.
- The headset is charged sufficiently.
- The operating instructions of the iPhone is in hand.

1 Remove both units of the headset from the charging case.



The headset turns on automatically. Check that the indicators (blue) flash.

2 Enter pairing mode on this headset.

When you pair the headset with a device for the first time after purchase or after initializing the headset (if the headset has no pairing information), the headset enters pairing mode automatically if you remove the headset from the charging case. In this case, proceed to step 3.

When you pair a second or subsequent device (the headset has pairing information for other devices), press and hold the buttons on both the left and right units for about 5 seconds.

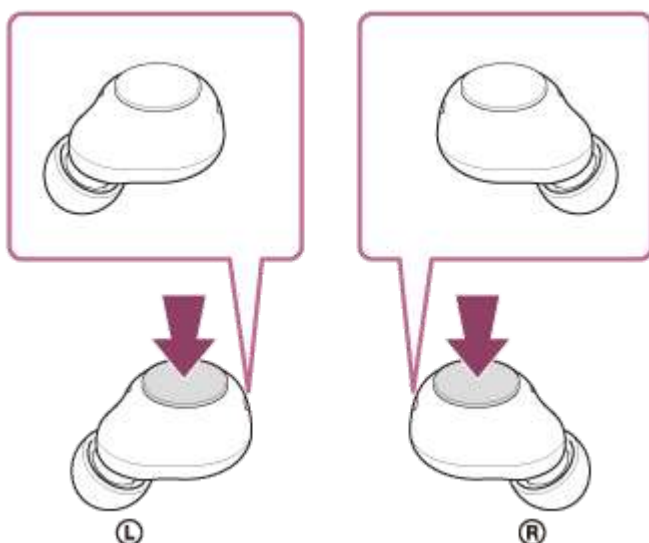

Check that the indicator (blue) on both units of the headset repeatedly flashes twice in a row. You will hear the voice guidance say “Bluetooth pairing”, from both headset units at the same time.

3 Unlock the screen of the iPhone if it is locked.

4 Find the headset on the iPhone.

1. Select [Settings].
2. Touch [Bluetooth].



3. Touch the switch to turn on the Bluetooth function.



5 Touch [WF-C500].



If Passkey (*) input is required, input "0000".

The headset and iPhone are paired and connected with each other.

The indicators (blue) on both units of the headset flash quickly for about 5 seconds.

You will hear the voice guidance say "Bluetooth connected" from the unit of the headset that was removed first from the charging case.

If they are not connected, see "[Connecting to a paired iPhone](#)".

If [WF-C500] does not appear on the display of the iPhone, try again from the beginning of step 4 .

* A Passkey may be called "Passcode", "PIN code", "PIN number", or "Password".

About the instruction manual video

Watch the video to find out how to perform the pairing for the first time.

https://rd1.sony.net/help/mdr/mov0028/h_zz/

Hint

- The operation above is an example. For more details, refer to the operating instructions supplied with your iPhone.
- To delete all Bluetooth pairing information, see "[Initializing the headset to restore factory settings](#)".

Note

- If pairing is not established within 5 minutes, pairing mode is canceled. In this case, set the headset into the charging case, and start the operation again from step ① .
- Once Bluetooth devices are paired, there is no need to pair them again, except in the following cases:
 - Pairing information has been deleted after repair, etc.
 - When a 9th device is paired.
The headset can be paired with up to 8 devices. If a new device is paired after 8 devices are already paired, the registration information of the paired device with the oldest connection date is overwritten with the information for the new device.
 - When the pairing information for the headset has been deleted from the Bluetooth device.
 - When the headset is initialized.
All of the pairing information is deleted. In this case, delete the pairing information for the headset from the connected device and then pair them again.
- The headset can be paired with multiple devices, but can only play music from 1 paired device at a time.

Related Topic

- [Wearing the headset](#)
- [How to make a wireless connection to Bluetooth devices](#)
- [Connecting to a paired iPhone](#)
- [Listening to music from a device via Bluetooth connection](#)
- [Disconnecting Bluetooth connection \(after use\)](#)
- [Initializing the headset to restore factory settings](#)

Connecting to a paired iPhone

1 Unlock the screen of the iPhone if it is locked.

2 Remove the headset from the charging case.

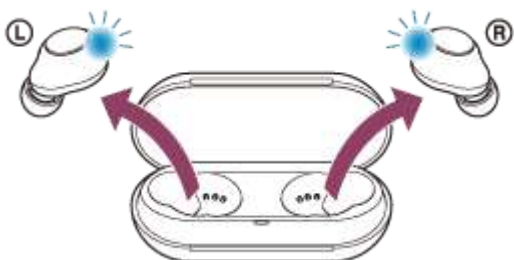

The headset turns on automatically. Check that the indicators (blue) flash.

If the headset has automatically connected to the last connected device, you will hear the voice guidance say “Bluetooth connected” from the unit of the headset that was removed first from the charging case.

Check the connection status on the iPhone. If it is not connected, proceed to step 3 .

3 Display the devices paired with the iPhone.

1. Select [Settings].
2. Touch [Bluetooth].



3. Touch the switch to turn on the Bluetooth function.



4 Touch [WF-C500].



You will hear the voice guidance say “Bluetooth connected” from the unit of the headset that was removed first from the charging case.

Hint

- The operation above is an example. For more details, refer to the operating instructions supplied with your iPhone.

Note

- If the last-connected Bluetooth device is placed near the headset, the headset may connect automatically to the device by simply turning on the headset. If this is the case, deactivate the Bluetooth function on the last-connected device or turn off the power.
- If you cannot connect your iPhone to the headset, delete the headset pairing information on your iPhone and perform the pairing again. As for the operations on your iPhone, refer to the operating instructions supplied with the iPhone.

Related Topic

- [Wearing the headset](#)
- [Using only one unit of the headset](#)
- [How to make a wireless connection to Bluetooth devices](#)
- [Pairing and connecting with an iPhone](#)
- [Listening to music from a device via Bluetooth connection](#)
- [Disconnecting Bluetooth connection \(after use\)](#)

Pairing and connecting with a computer (Windows® 10)

The operation to register the device that you wish to connect to is called “pairing”. First, pair a device to use it with the headset for the first time.

Before starting the operation, make sure of the following:

- Your computer has a Bluetooth function that supports music playback connections (A2DP).
- The computer is placed within 1 m (3 feet) of the headset.
- The headset is charged sufficiently.
- The operating instructions of the computer is in hand.
- Depending on the computer you are using, the built-in Bluetooth adaptor may need to be turned on. If you do not know how to turn on the Bluetooth adaptor or are unsure if your computer has a built-in Bluetooth adaptor, refer to the operating instructions supplied with the computer.
- If your OS version is Windows 10 version 1803 or later, the Swift Pair function will make pairing easier. To use the Swift Pair function, click the [Start] button - [Settings] - [Devices] - [Bluetooth & other devices], and check [Show notifications to connect using Swift Pair].

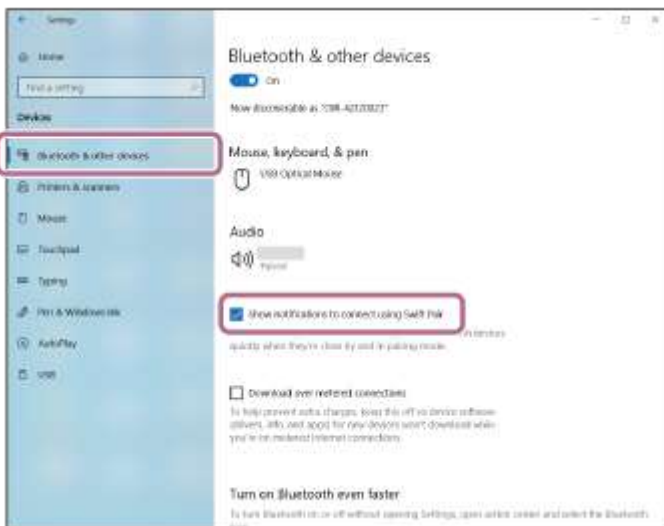

1 Remove both units of the headset from the charging case.

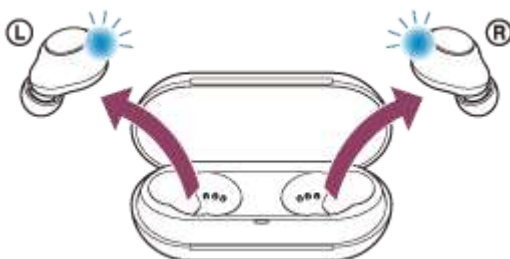

The headset turns on automatically. Check that the indicators (blue) flash.

2 Enter pairing mode on this headset.

When you pair the headset with a device for the first time after purchase or after initializing the headset (if the headset has no pairing information), the headset enters pairing mode automatically if you remove the headset from the charging case. In this case, proceed to step 3.

When you pair a second or subsequent device (the headset has pairing information for other devices), press and hold the buttons on both the left and right units for about 5 seconds.

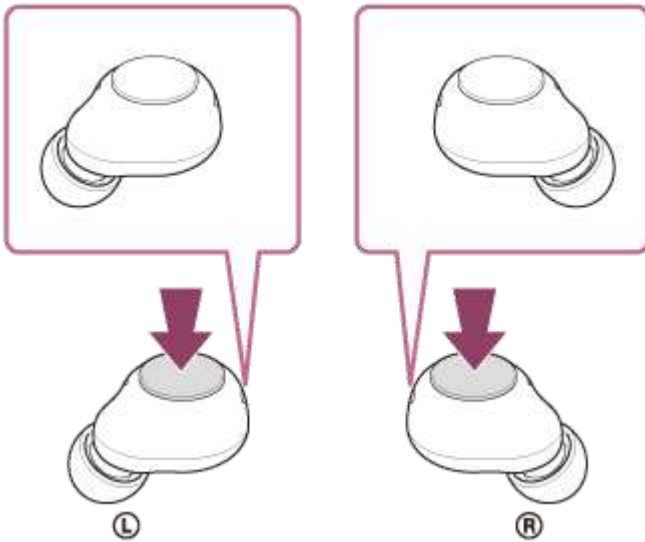

Check that the indicator (blue) on both units of the headset repeatedly flashes twice in a row. You will hear the voice guidance say “Bluetooth pairing” from both headset units at the same time.

3 Wake the computer up if the computer is in standby (sleep) or hibernation mode.

4 Pair the headset using the computer.

To connect using the Swift Pair function

1. Select [Connect] from the pop up menu displayed on your computer screen.

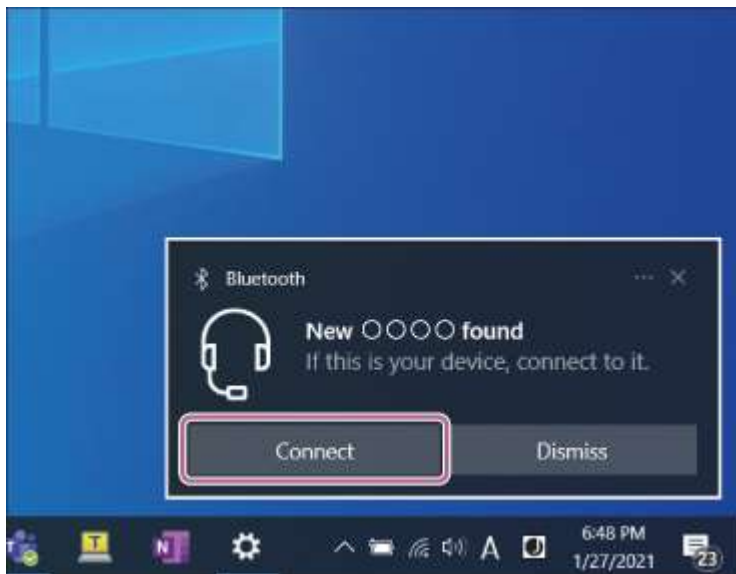

To connect without using the Swift Pair function

1. Click the [Start] button, then [Settings].

2. Click [Devices].



3. Click the [Bluetooth & other devices] tab, click the [Bluetooth] switch to turn on the Bluetooth function, then click [Add Bluetooth or other device].



4. Click [Bluetooth].

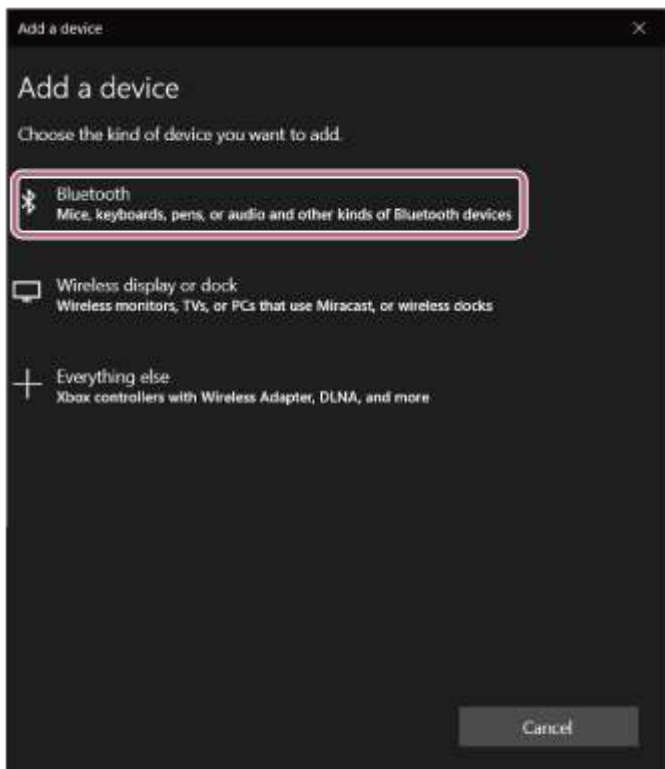

5. Click [WF-C500].

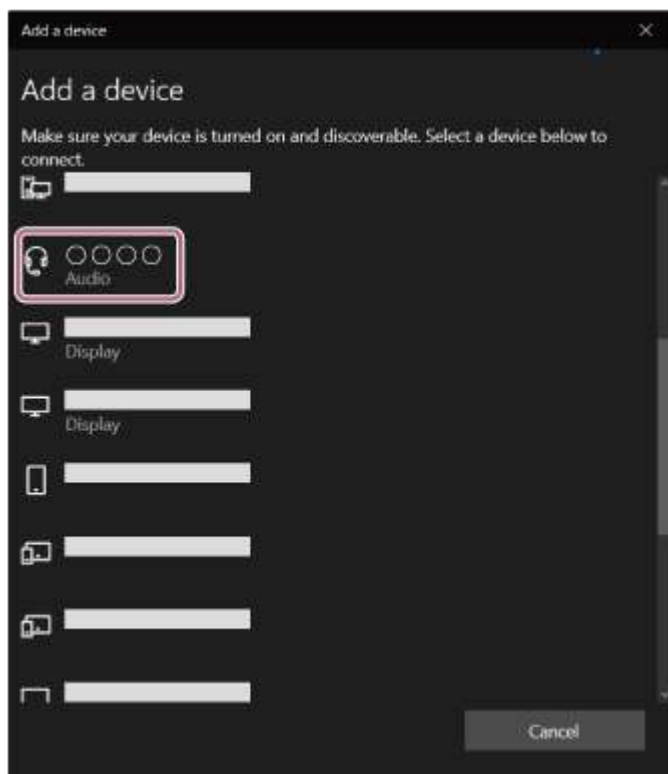

If Passkey (*) input is required, input "0000".

The headset and computer are paired and connected with each other.

The indicators (blue) on both units of the headset flash quickly for about 5 seconds.

You will hear the voice guidance say "Bluetooth connected" from the unit of the headset that was removed first from the charging case.

If they are not connected, see ["Connecting to a paired computer \(Windows 10\)"](#).

If [WF-C500] does not appear on the computer screen, try again from "To connect without using the Swift Pair function" of step 4 .

* A Passkey may be called "Passcode", "PIN code", "PIN number", or "Password".

Hint

- The operation above is an example. For more details, refer to the operating instructions supplied with the computer.
- To delete all Bluetooth pairing information, see ["Initializing the headset to restore factory settings"](#).

Note

- If pairing is not established within 5 minutes, pairing mode is canceled. In this case, set the headset into the charging case, and start the operation again from step 1 .
- Once Bluetooth devices are paired, there is no need to pair them again, except in the following cases:
 - Pairing information has been deleted after repair, etc.
 - When a 9th device is paired.
The headset can be paired with up to 8 devices. If a new device is paired after 8 devices are already paired, the registration information of the paired device with the oldest connection date is overwritten with the information for the new device.
 - When the pairing information for the headset has been deleted from the Bluetooth device.
 - When the headset is initialized.
All of the pairing information is deleted. In this case, delete the pairing information for the headset from the connected device and then pair them again.
- The headset can be paired with multiple devices, but can only play music from 1 paired device at a time.

Related Topic

- Wearing the headset
- How to make a wireless connection to Bluetooth devices
- Connecting to a paired computer (Windows 10)
- Listening to music from a device via Bluetooth connection
- Disconnecting Bluetooth connection (after use)
- Initializing the headset to restore factory settings

5-030-793-11(2) Copyright 2021 Sony Corporation

Pairing and connecting with a computer (Windows 8.1)

The operation to register the device that you wish to connect to is called "pairing". First, pair a device to use it with the headset for the first time.

Before starting the operation, make sure of the following:

- Your computer has a Bluetooth function that supports music playback connections (A2DP).
- The computer is placed within 1 m (3 feet) of the headset.
- The headset is charged sufficiently.
- The operating instructions of the computer is in hand.
- Depending on the computer you are using, the built-in Bluetooth adaptor may need to be turned on. If you do not know how to turn on the Bluetooth adaptor or are unsure if your computer has a built-in Bluetooth adaptor, refer to the operating instructions supplied with the computer.

1 Remove both units of the headset from the charging case.



The headset turns on automatically. Check that the indicators (blue) flash.

2 Enter pairing mode on this headset.

When you pair the headset with a device for the first time after purchase or after initializing the headset (if the headset has no pairing information), the headset enters pairing mode automatically if you remove the headset from the charging case. In this case, proceed to step 3.

When you pair a second or subsequent device (the headset has pairing information for other devices), press and hold the buttons on both the left and right units for about 5 seconds.

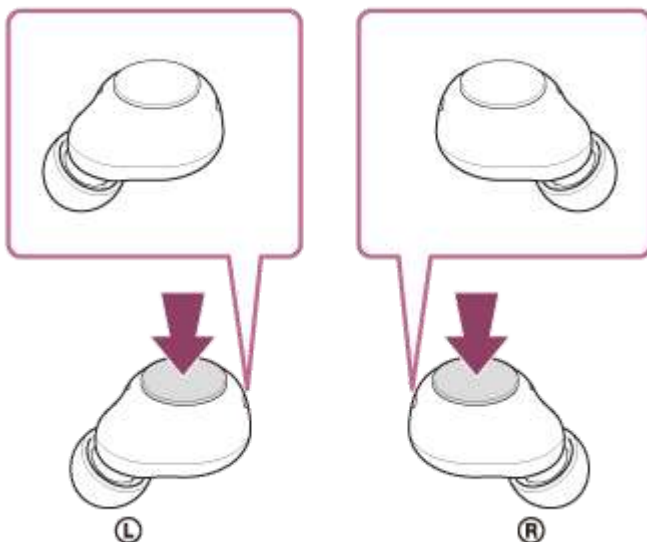

Check that the indicator (blue) on both units of the headset repeatedly flashes twice in a row.

You will hear the voice guidance say “Bluetooth pairing”, from both headset units at the same time.

3 Wake the computer up if the computer is in standby (sleep) or hibernation mode.

4 Pair the headset using the computer.

1. Move the mouse pointer to the top-right corner of the screen (when using a touch panel, swipe from the right edge of the screen), then select [Settings] from the Charm Bar.



2. Select [Change PC Settings] of the [Settings] charm.



3. Select [PC and devices] of the [PC Settings] screen.

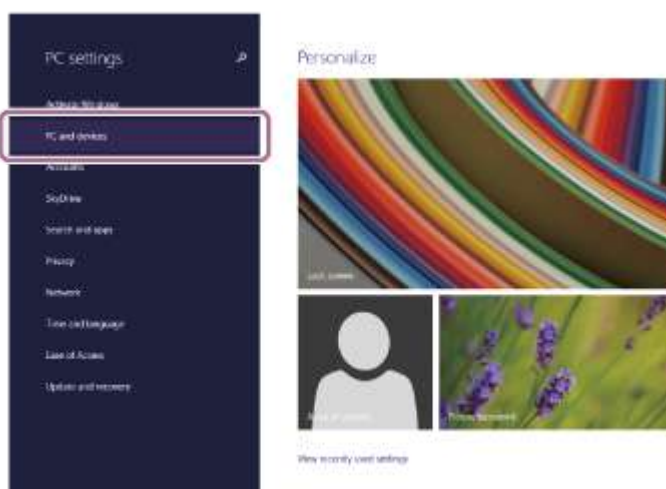

4. Select [Bluetooth].

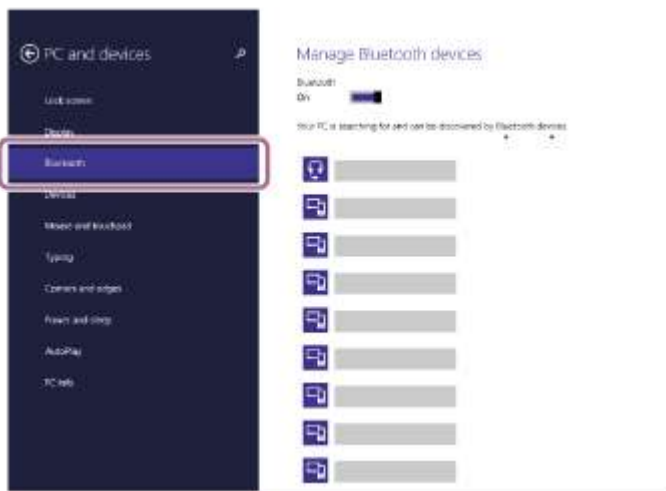

5. Select [WF-C500], then select [Pair].

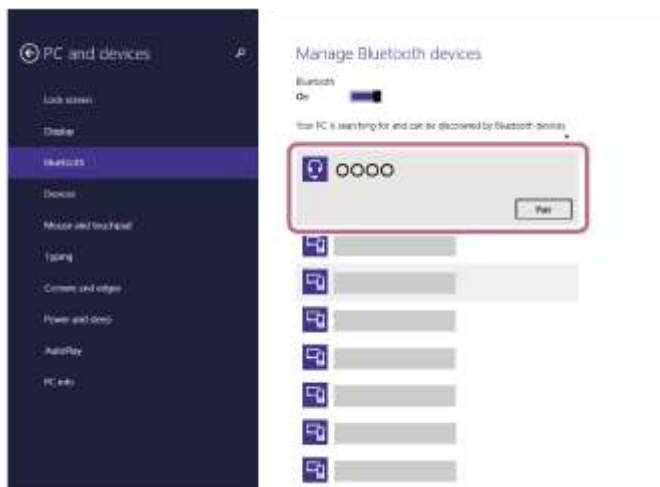

If Passkey (*) input is required, input "0000".

The headset and computer are paired and connected with each other.

The indicators (blue) on both units of the headset flash quickly for about 5 seconds.

You will hear the voice guidance say "Bluetooth connected" from the unit of the headset that was removed first from the charging case.

If they are not connected, see "[Connecting to a paired computer \(Windows 8.1\)](#)".

If [WF-C500] does not appear on the computer screen, try again from the beginning of step 4 .

* A Passkey may be called "Passcode", "PIN code", "PIN number", or "Password".

Hint

- The operation above is an example. For more details, refer to the operating instructions supplied with the computer.
- To delete all Bluetooth pairing information, see "[Initializing the headset to restore factory settings](#)".

Note

- If pairing is not established within 5 minutes, pairing mode is canceled. In this case, set the headset into the charging case, and start the operation again from step 1 .
- Once Bluetooth devices are paired, there is no need to pair them again, except in the following cases:
 - Pairing information has been deleted after repair, etc.
 - When a 9th device is paired.
The headset can be paired with up to 8 devices. If a new device is paired after 8 devices are already paired, the registration information of the paired device with the oldest connection date is overwritten with the information for the new device.
 - When the pairing information for the headset has been deleted from the Bluetooth device.
 - When the headset is initialized.
All of the pairing information is deleted. In this case, delete the pairing information for the headset from the connected device

and then pair them again.

- The headset can be paired with multiple devices, but can only play music from 1 paired device at a time.

Related Topic

- [Wearing the headset](#)
- [How to make a wireless connection to Bluetooth devices](#)
- [Connecting to a paired computer \(Windows 8.1\)](#)
- [Listening to music from a device via Bluetooth connection](#)
- [Disconnecting Bluetooth connection \(after use\)](#)
- [Initializing the headset to restore factory settings](#)

5-030-793-11(2) Copyright 2021 Sony Corporation

Pairing and connecting with a computer (Mac)

The operation to register the device that you wish to connect to is called “pairing”. First, pair a device to use it with the headset for the first time.

Compatible OS

macOS (version 10.15 or later)

Before starting the operation, make sure of the following:

- Your computer has a Bluetooth function that supports music playback connections (A2DP).
- The computer is placed within 1 m (3 feet) of the headset.
- The headset is charged sufficiently.
- The operating instructions of the computer is in hand.
- Depending on the computer you are using, the built-in Bluetooth adaptor may need to be turned on. If you do not know how to turn on the Bluetooth adaptor or are unsure if your computer has a built-in Bluetooth adaptor, refer to the operating instructions supplied with the computer.
- Set the computer speaker to the ON mode.

If the computer speaker is set to the  “OFF” mode, no sound is heard from the headset.

Computer speaker in the ON mode



1 Remove both units of the headset from the charging case.

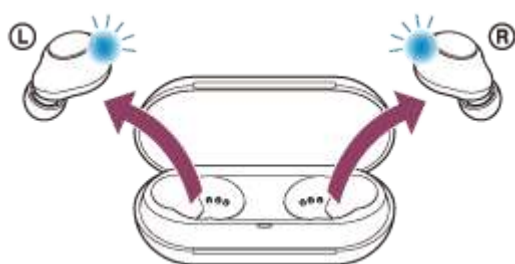

The headset turns on automatically. Check that the indicators (blue) flash.

2 Enter pairing mode on this headset.

When you pair the headset with a device for the first time after purchase or after initializing the headset (if the headset has no pairing information), the headset enters pairing mode automatically if you remove the headset from the charging case. In this case, proceed to step **3**.

When you pair a second or subsequent device (the headset has pairing information for other devices), press and hold the buttons on both the left and right units for about 5 seconds.

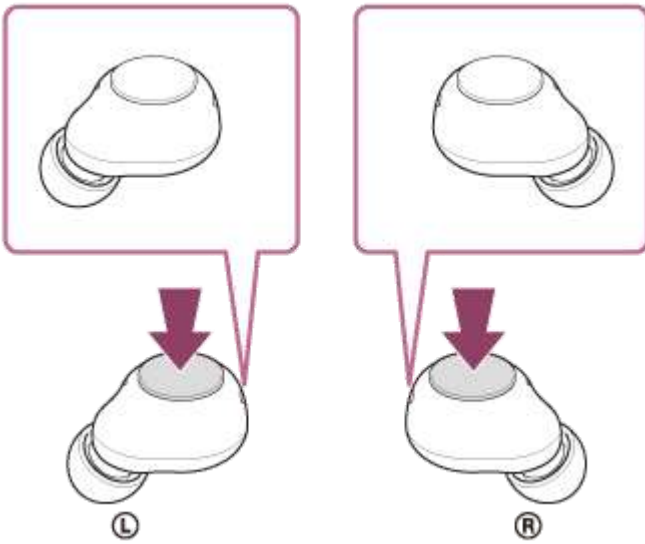

Check that the indicator (blue) on both units of the headset repeatedly flashes twice in a row. You will hear the voice guidance say “Bluetooth pairing”, from both headset units at the same time.

3 Wake the computer up if the computer is in standby (sleep) or hibernation mode.

4 Pair the headset using the computer.

1. Select [ (System Preferences)] - [Bluetooth] from the Dock at the bottom of the screen.



2. Select [WF-C500] of the [Bluetooth] screen and click [Connect].



If Passkey (*) input is required, input “0000”.

The headset and computer are paired and connected with each other.

The indicators (blue) on both units of the headset flash quickly for about 5 seconds.

You will hear the voice guidance say “Bluetooth connected” from the unit of the headset that was removed first from the charging case.

If they are not connected, see [“Connecting to a paired computer \(Mac\)”](#).

If [WF-C500] does not appear on the computer screen, try again from the beginning of step ④ .

* A Passkey may be called “Passcode”, “PIN code”, “PIN number”, or “Password”.

Hint

- The operation above is an example. For more details, refer to the operating instructions supplied with the computer.
- To delete all Bluetooth pairing information, see [“Initializing the headset to restore factory settings”](#).

Note

- If pairing is not established within 5 minutes, pairing mode is canceled. In this case, set the headset into the charging case, and start the operation again from step ① .
- Once Bluetooth devices are paired, there is no need to pair them again, except in the following cases:
 - Pairing information has been deleted after repair, etc.
 - When a 9th device is paired.
The headset can be paired with up to 8 devices. If a new device is paired after 8 devices are already paired, the registration information of the paired device with the oldest connection date is overwritten with the information for the new device.
 - When the pairing information for the headset has been deleted from the Bluetooth device.
 - When the headset is initialized.
All of the pairing information is deleted. In this case, delete the pairing information for the headset from the connected device and then pair them again.
- The headset can be paired with multiple devices, but can only play music from 1 paired device at a time.

Related Topic

- [Wearing the headset](#)
- [How to make a wireless connection to Bluetooth devices](#)
- [Connecting to a paired computer \(Mac\)](#)
- [Listening to music from a device via Bluetooth connection](#)
- [Disconnecting Bluetooth connection \(after use\)](#)
- [Initializing the headset to restore factory settings](#)

Connecting to a paired computer (Windows 10)

Before starting the operation, make sure of the following:

- Depending on the computer you are using, the built-in Bluetooth adaptor may need to be turned on. If you do not know how to turn on the Bluetooth adaptor or are unsure if your computer has a built-in Bluetooth adaptor, refer to the operating instructions supplied with the computer.

1 Wake the computer up if the computer is in standby (sleep) or hibernation mode.

2 Remove the headset from the charging case.



The headset turns on automatically. Check that the indicators (blue) flash.

If the headset has automatically connected to the last connected device, you will hear the voice guidance say “Bluetooth connected” from the unit of the headset that was removed first from the charging case.

Check the connection status on the computer. If it is not connected, proceed to step **3**.

3 Select the headset using the computer.

1. Right-click the speaker icon on the toolbar, then select [Open Sound settings].

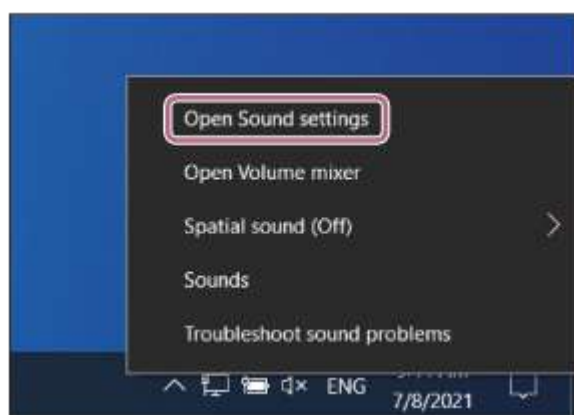

2. From the [Choose your output device] drop-down menu, select [Headphones (WF-C500 Stereo)].

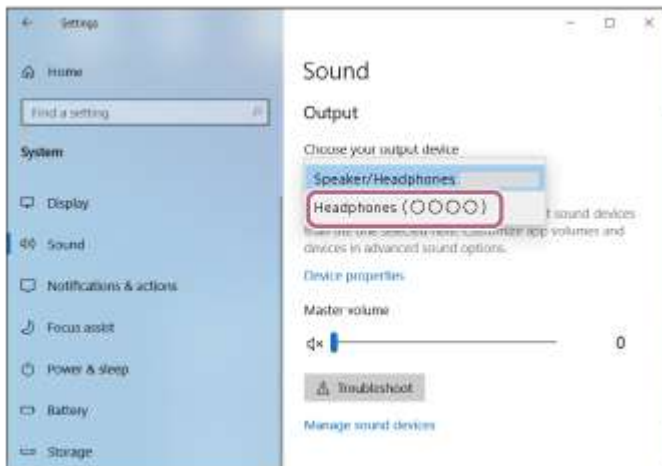

If [Headphones (WF-C500 Stereo)] is not displayed on the drop-down menu, click [Sound Control Panel] and then right-click on the [Playback] tab of the [Sound] screen to check [Show Disconnected Devices].

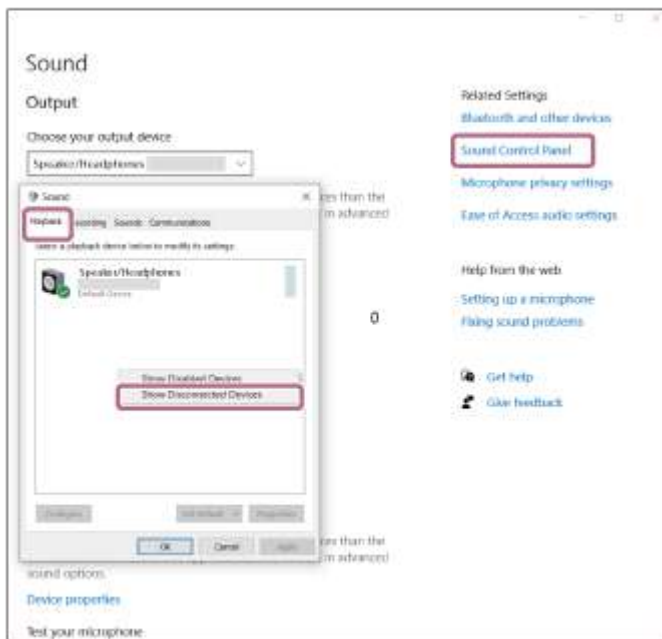

3. Select [Connect] from the displayed menu.



The connection is established. You will hear the voice guidance say “Bluetooth connected” from the unit of the headset that was removed first from the charging case.

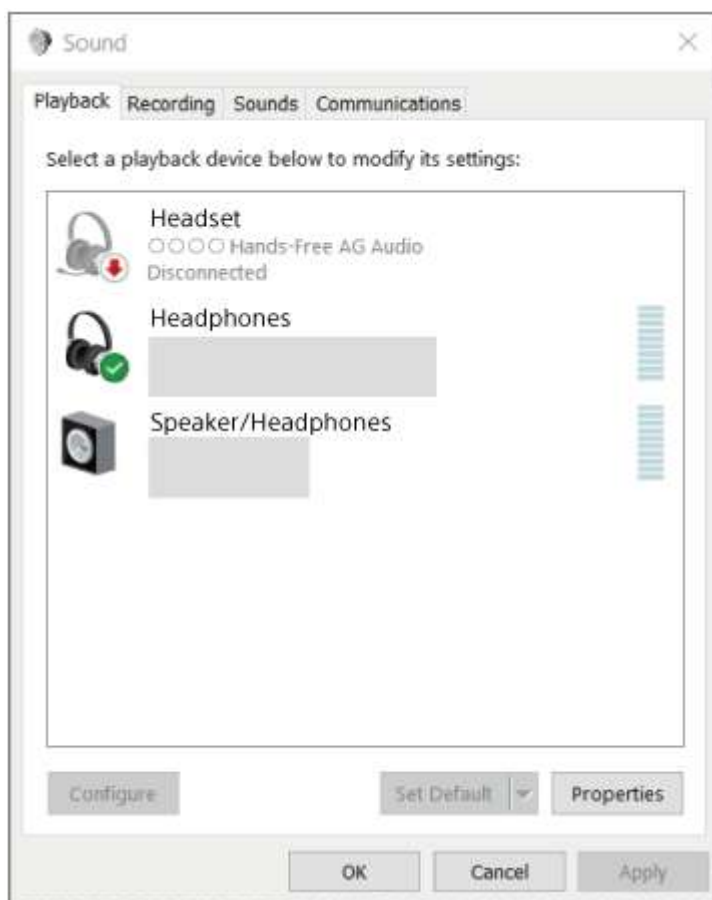

- The operation above is an example. For more details, refer to the operating instructions supplied with the computer.

Note

- If the music playback sound quality is poor, check that the A2DP function which supports music playback connections is enabled in the computer settings. For more details, refer to the operating instructions supplied with the computer.
- If the last-connected Bluetooth device is placed near the headset, the headset may connect automatically to the device by simply turning on the headset. If this is the case, deactivate the Bluetooth function on the last-connected device or turn off the power.
- If you cannot connect your computer to the headset, delete the headset pairing information on your computer and perform the pairing again. As for the operations on your computer, refer to the operating instructions supplied with the computer.

Related Topic

- [Wearing the headset](#)
- [Using only one unit of the headset](#)
- [How to make a wireless connection to Bluetooth devices](#)
- [Pairing and connecting with a computer \(Windows® 10\)](#)
- [Listening to music from a device via Bluetooth connection](#)
- [Disconnecting Bluetooth connection \(after use\)](#)

Connecting to a paired computer (Windows 8.1)

Before starting the operation, make sure of the following:

- Depending on the computer you are using, the built-in Bluetooth adaptor may need to be turned on. If you do not know how to turn on the Bluetooth adaptor or are unsure if your computer has a built-in Bluetooth adaptor, refer to the operating instructions supplied with the computer.

1 Wake the computer up if the computer is in standby (sleep) or hibernation mode.

2 Remove the headset from the charging case.



The headset turns on automatically. Check that the indicators (blue) flash.

If the headset has automatically connected to the last connected device, you will hear the voice guidance say “Bluetooth connected” from the unit of the headset that was removed first from the charging case.

Check the connection status on the computer. If it is not connected, proceed to step **3**.

3 Select the headset using the computer.

1. Select [Desktop] on the Start screen.
2. Right-click the [Start] button, then select [Control Panel] from the pop-up menu.
3. Select [Hardware and Sound] - [Sound].

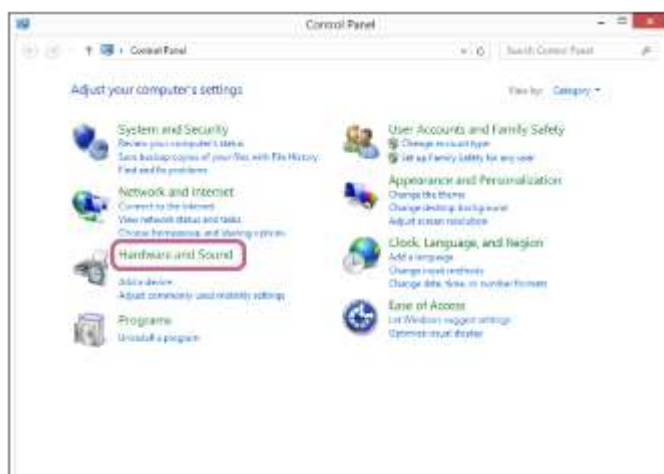

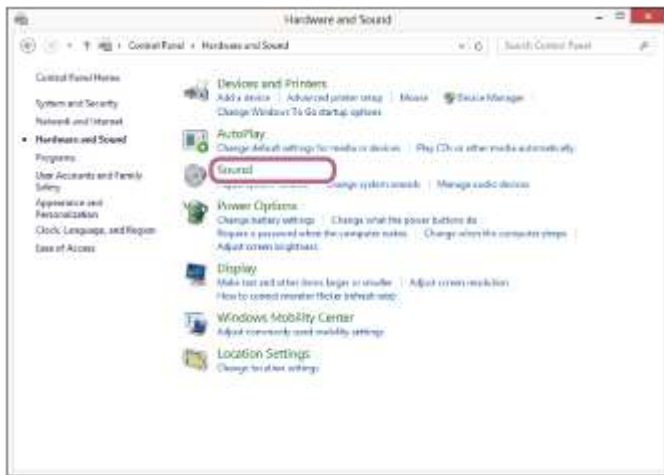

4. Right-click [WF-C500].
If [WF-C500] is not displayed on the [Sound] screen, right-click on the [Sound] screen, then check [Show Disconnected Devices].

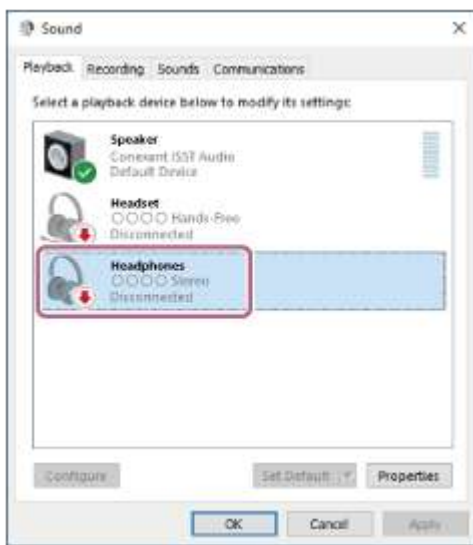

5. Select [Connect] from the displayed menu.

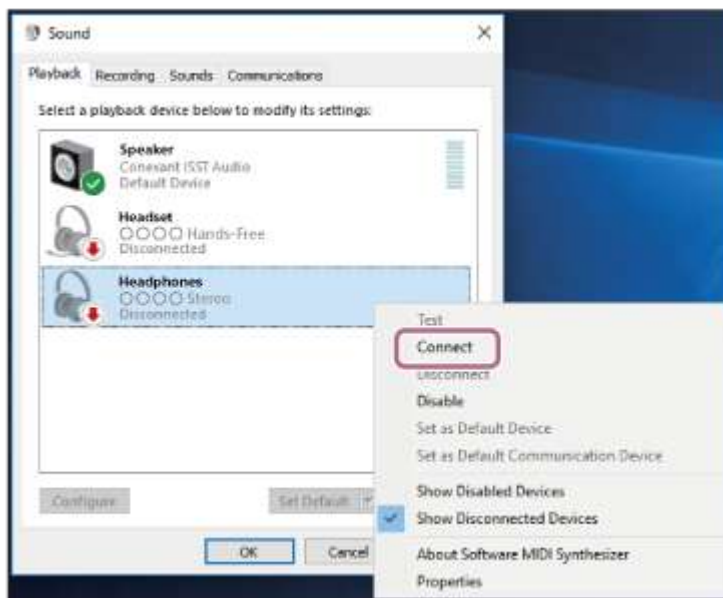

The connection is established. You will hear the voice guidance say “Bluetooth connected” from the unit of the headset that was removed first from the charging case.



Hint

- The operation above is an example. For more details, refer to the operating instructions supplied with the computer.

Note

- If the music playback sound quality is poor, check that the A2DP function which supports music playback connections is enabled in the computer settings. For more details, refer to the operating instructions supplied with the computer.
- If the last-connected Bluetooth device is placed near the headset, the headset may connect automatically to the device by simply turning on the headset. If this is the case, deactivate the Bluetooth function on the last-connected device or turn off the power.
- If you cannot connect your computer to the headset, delete the headset pairing information on your computer and perform the pairing again. As for the operations on your computer, refer to the operating instructions supplied with the computer.

Related Topic

- [Wearing the headset](#)
- [Using only one unit of the headset](#)
- [How to make a wireless connection to Bluetooth devices](#)
- [Pairing and connecting with a computer \(Windows 8.1\)](#)
- [Listening to music from a device via Bluetooth connection](#)
- [Disconnecting Bluetooth connection \(after use\)](#)

Connecting to a paired computer (Mac)

Compatible OS

macOS (version 10.15 or later)

Before starting the operation, make sure of the following:

- Depending on the computer you are using, the built-in Bluetooth adaptor may need to be turned on. If you do not know how to turn on the Bluetooth adaptor or are unsure if your computer has a built-in Bluetooth adaptor, refer to the operating instructions supplied with the computer.
- Set the computer speaker to the ON mode.
If the computer speaker is set to the  "OFF" mode, no sound is heard from the headset.

Computer speaker in the ON mode

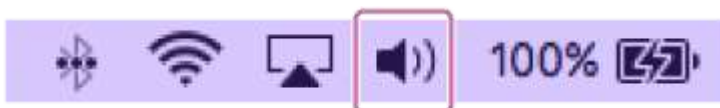

1 Wake the computer up if the computer is in standby (sleep) or hibernation mode.

2 Remove the headset from the charging case.

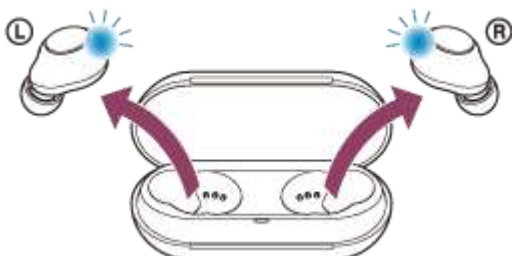

The headset turns on automatically. Check that the indicators (blue) flash.

If the headset has automatically connected to the last connected device, you will hear the voice guidance say "Bluetooth connected" from the unit of the headset that was removed first from the charging case.

Check the connection status on the computer. If it is not connected, proceed to step **3**.

3 Select the headset using the computer.

1. Select [ (System Preferences)] - [Bluetooth] from the Dock at the bottom of the screen.



2. Click [WF-C500] on the [Bluetooth] screen while pressing the computer Control button and select [Connect] from the pop up menu.



The connection is established. You will hear the voice guidance say “Bluetooth connected” from the unit of the headset that was removed first from the charging case.

Hint

- The operation above is an example. For more details, refer to the operating instructions supplied with the computer.

Note

- If the music playback sound quality is poor, check that the A2DP function which supports music playback connections is enabled in the computer settings. For more details, refer to the operating instructions supplied with the computer.
- If the last-connected Bluetooth device is placed near the headset, the headset may connect automatically to the device by simply turning on the headset. If this is the case, deactivate the Bluetooth function on the last-connected device or turn off the power.
- If you cannot connect your computer to the headset, delete the headset pairing information on your computer and perform the pairing again. As for the operations on your computer, refer to the operating instructions supplied with the computer.

Related Topic

- [Wearing the headset](#)
- [Using only one unit of the headset](#)
- [How to make a wireless connection to Bluetooth devices](#)
- [Pairing and connecting with a computer \(Mac\)](#)
- [Listening to music from a device via Bluetooth connection](#)

- [Disconnecting Bluetooth connection \(after use\)](#)

5-030-793-11(2) Copyright 2021 Sony Corporation

Pairing and connecting with a Bluetooth device

The operation to register the device that you wish to connect to is called “pairing”. First, pair a device to use it with the headset for the first time.

Before starting the operation, make sure of the following:

- The Bluetooth device is placed within 1 m (3 feet) of the headset.
- The headset is charged sufficiently.
- The operating instructions of the Bluetooth device is in hand.

1 Remove both units of the headset from the charging case.

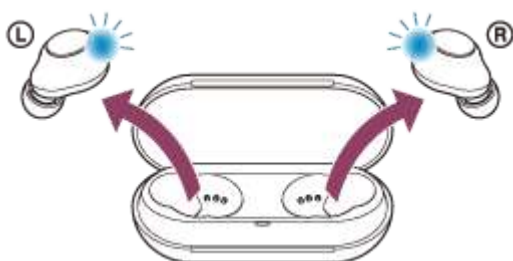

The headset turns on automatically. Check that the indicators (blue) flash.

2 Enter pairing mode on this headset.

When you pair the headset with a device for the first time after purchase or after initializing the headset (if the headset has no pairing information), the headset enters pairing mode automatically if you remove the headset from the charging case. In this case, proceed to step 3.

When you pair a second or subsequent device (the headset has pairing information for other devices), press and hold the buttons on both the left and right units for about 5 seconds.

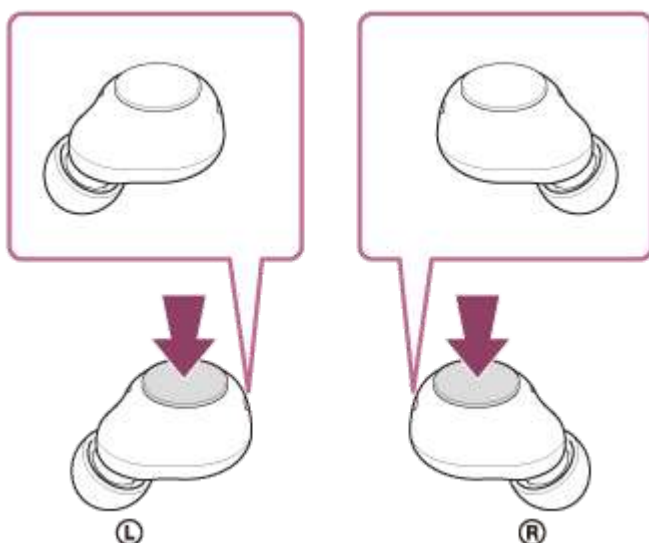

Check that the indicator (blue) on both units of the headset repeatedly flashes twice in a row. You will hear the voice guidance say “Bluetooth pairing”, from both headset units at the same time.

3 Perform the pairing procedure on the Bluetooth device to search for this headset.

[WF-C500] will be displayed on the list of detected devices on the screen of the Bluetooth device. If it is not displayed, repeat from step 2 .

4 Select [WF-C500] displayed on the screen of the Bluetooth device for pairing.

If Passkey (*) input is required, input "0000".

* A Passkey may be called "Passcode", "PIN code", "PIN number", or "Password".

5 Make the Bluetooth connection from the Bluetooth device.

Some devices automatically connect with the headset when the pairing is complete.

The indicators (blue) on both units of the headset flash quickly for about 5 seconds.

You will hear the voice guidance say "Bluetooth connected" from the unit of the headset that was removed first from the charging case.

If they are not connected, see ["Connecting to a paired Bluetooth device"](#).

Hint

- The operation above is an example. For more details, refer to the operating instructions supplied with the Bluetooth device.
- To delete all Bluetooth pairing information, see ["Initializing the headset to restore factory settings"](#).

Note

- If pairing is not established within 5 minutes, pairing mode is canceled. In this case, set the headset into the charging case, and start the operation again from step 1 .
- Once Bluetooth devices are paired, there is no need to pair them again, except in the following cases:
 - Pairing information has been deleted after repair, etc.
 - When a 9th device is paired.
The headset can be paired with up to 8 devices. If a new device is paired after 8 devices are already paired, the registration information of the paired device with the oldest connection date is overwritten with the information for the new device.
 - When the pairing information for the headset has been deleted from the Bluetooth device.
 - When the headset is initialized.
All of the pairing information is deleted. In this case, delete the pairing information for the headset from the connected device and then pair them again.
- The headset can be paired with multiple devices, but can only play music from 1 paired device at a time.

Related Topic

- [Wearing the headset](#)
- [How to make a wireless connection to Bluetooth devices](#)
- [Connecting to a paired Bluetooth device](#)
- [Listening to music from a device via Bluetooth connection](#)
- [Disconnecting Bluetooth connection \(after use\)](#)
- [Initializing the headset to restore factory settings](#)

Connecting to a paired Bluetooth device

1 Remove the headset from the charging case.



The headset turns on automatically. Check that the indicators (blue) flash.

If the headset has automatically connected to the last connected device, you will hear the voice guidance say “Bluetooth connected” from the unit of the headset that was removed first from the charging case.

Check the connection status on the Bluetooth device. If it is not connected, proceed to step 2 .

2 Make the Bluetooth connection from the Bluetooth device.

As for the operations on your Bluetooth device, refer to the operating instructions supplied with the Bluetooth device.

You will hear the voice guidance say “Bluetooth connected” from the unit of the headset that was removed first from the charging case.

Hint

- The operation above is an example. For more details, refer to the operating instructions supplied with the Bluetooth device.

Note

- If the last-connected Bluetooth device is placed near the headset, the headset may connect automatically to the device by simply turning on the headset. If this is the case, deactivate the Bluetooth function on the last-connected device or turn off the power.
- If you cannot connect your Bluetooth device to the headset, delete the headset pairing information on your Bluetooth device and perform the pairing again. As for the operations on your Bluetooth device, refer to the operating instructions supplied with the Bluetooth device.

Related Topic

- [Wearing the headset](#)
- [Using only one unit of the headset](#)
- [How to make a wireless connection to Bluetooth devices](#)
- [Pairing and connecting with a Bluetooth device](#)
- [Listening to music from a device via Bluetooth connection](#)
- [Disconnecting Bluetooth connection \(after use\)](#)

Listening to music from a device via Bluetooth connection

If your Bluetooth device supports the following profiles, you can enjoy listening to music and control the device from your headset via Bluetooth connection.

- A2DP (Advanced Audio Distribution Profile)
You can enjoy high-quality music wirelessly.
- AVRCP (Audio Video Remote Control Profile)
You can adjust the volume, etc.

The operation may vary depending on the Bluetooth device. Refer to the operating instructions supplied with the Bluetooth device.

1 Put the headset units into both ears.

Put the headset unit with the **L** (left) mark into your left ear and the headset unit with the **R** (right) mark into your right ear. The left unit has a tactile dot.

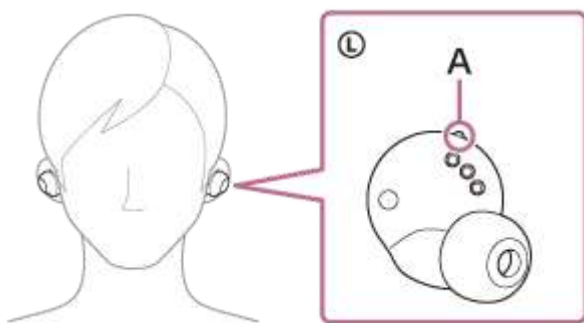

A: Tactile dot

Twist the headset unit to slide the earbud tip deep into your ear canal.

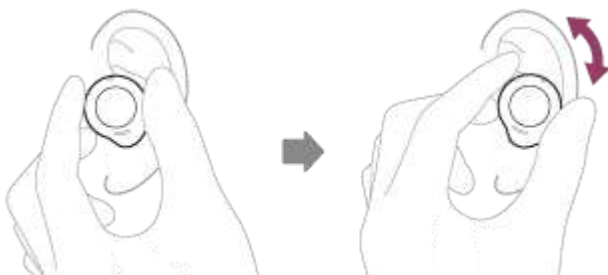

2 Connect the headset to a Bluetooth device.

3 Operate the Bluetooth device to start playback and adjust the volume to a moderate level.

4 Press the button on the left unit to adjust the volume.

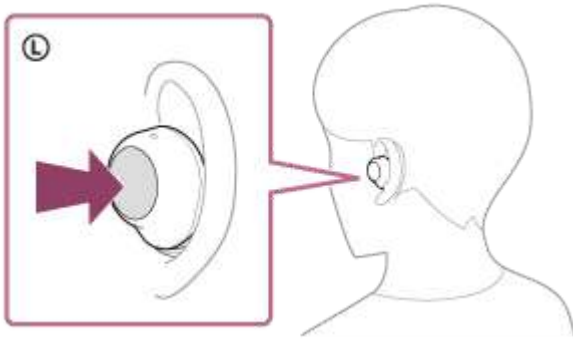

- Increase the volume: Press the button on the left unit once during music playback to increase the volume by 1 step.
- Decrease the volume: Press and hold the button on the left unit during music playback to decrease the volume continuously. Release the button at the desired volume level.

When the volume reaches the maximum or minimum, an alarm sounds.

Hint

- The headset supports SCMS-T content protection. You can enjoy music and other audio on the headset from a device such as a portable TV that supports SCMS-T content protection.
- Depending on the Bluetooth device, it may be necessary to adjust the volume or set the audio output setting on the device.
- The headset volume during a call and during music playback can be independently adjusted. Changing the call volume does not change the volume of music playback and vice versa.
- You can also listen to music by removing only one unit from the charging case and putting it into your ear.
When only the right unit is worn in your ear, use the button on the right unit to play music. In this case, adjust the volume on the connected device.
When only the left unit is worn in your ear, operate the connected device to play music. In this case, you can adjust the volume with the button on the left unit.
When you are listening to music with only one unit, if you put the other unit into the other ear, you can listen to music with both units.

Note

- If the communication condition is poor, the Bluetooth device may react incorrectly to the operation on the headset.

Related Topic

- [Wearing the headset](#)
- [Using only one unit of the headset](#)
- [How to make a wireless connection to Bluetooth devices](#)
- [Controlling the audio device \(Bluetooth connection\)](#)

Controlling the audio device (Bluetooth connection)

If your Bluetooth device supports the device operating function (compatible protocol: AVRCP), then the following operations are available. The available functions may vary depending on the Bluetooth device, so refer to the operating instructions supplied with the device.

You can use the button on the right unit to perform the following operations.

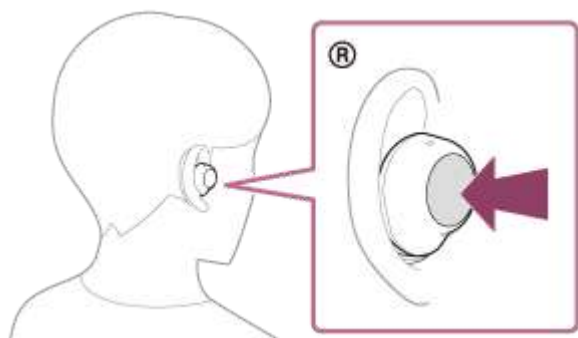

- Play/Pause: Press the button once briefly.
- Skip to the beginning of the next track: Press the button twice quickly.
- Skip to the beginning of the previous track (or the current track during playback): Press the button 3 times quickly.

You can use the button on the left unit to perform the following operations.

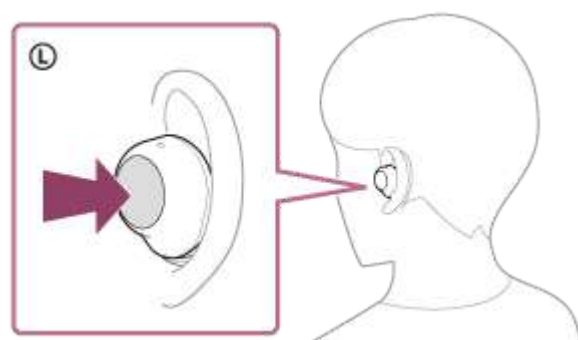

- Increase the volume: Press the button on the left unit once during music playback to increase the volume by 1 step.
- Decrease the volume: Press and hold the button on the left unit during music playback to decrease the volume continuously. Release the button at the desired volume level.

When the volume reaches the maximum or minimum, an alarm sounds.

Note

- If the communication condition is poor, the Bluetooth device may react incorrectly to the operation on the headset.
- The available operations may vary depending on the connected device, the music software, or app used. In some cases, it may operate differently or may not work even when the operations described above are performed.
- When you use an iPhone, Siri may be activated by pressing and holding the button on the right unit.



Disconnecting Bluetooth connection (after use)

1 Disconnect the Bluetooth connection by operating the Bluetooth device.

You will hear the voice guidance say "Bluetooth disconnected" from the left or right unit of the headset.

2 Set the headset into the charging case.

The headset turns off.

Hint

- When you finish playing music, the Bluetooth connection may terminate automatically depending on the Bluetooth device.

Related Topic

- [Turning off the headset](#)

Wireless Stereo Headset
WF-C500

About the sound quality mode

The following 2 sound quality modes during Bluetooth playback can be selected. You can switch the settings and check the sound quality mode with the “Sony | Headphones Connect” app.

Priority on sound quality mode: Prioritizes the sound quality.

Priority on stable connection mode: Prioritizes the stable connection (default).

- When you want to prioritize the sound quality, select the “Priority on sound quality” mode.
- If the connection is unstable, such as when producing only intermittent sound, select the “Priority on stable connection mode”.

Note

- The playback time may shorten depending on the sound quality and the conditions under which you are using the headset.
- Depending on the ambient conditions in the area where you are using the headset, intermittent sound may still occur even if the “Priority on stable connection mode” is selected.

Related Topic

- [What you can do with the “Sony | Headphones Connect” app](#)

Wireless Stereo Headset
WF-C500

Supported codecs

A codec is an “audio coding algorithm” used when transmitting sound wirelessly via Bluetooth connection. The headset supports the following 2 codecs for music playback via an A2DP connection: SBC and AAC.

- SBC

This is an abbreviation for Subband Codec.

SBC is the standard audio coding technology used in Bluetooth devices.

All Bluetooth devices support SBC.

- AAC

This is an abbreviation for Advanced Audio Coding.

AAC is mainly used in Apple products such as iPhone that can provide a higher sound quality than that of SBC.

When music in one of the above codecs is transmitted from a connected device, the headset switches to that codec automatically and plays back the music in the same codec.

If the connected device supports a codec of higher sound quality than SBC, you may need to set the device beforehand to enjoy music with the desired codec from the supported codecs.

Refer to the operating instructions supplied with the device regarding setting the codec.

Related Topic

- [About the sound quality mode](#)

Wireless Stereo Headset
WF-C500

About the DSEE function

The DSEE function complements the high-range sound, which is often lost from compressed sound sources, in the headset to the equivalent of CD sound quality.

Sound sources compressed by streaming playback, MP3, Bluetooth transmission codec, etc. are played with natural and expansive sound.

The DSEE function can be set up on the “Sony | Headphones Connect” app, and is only available when connected to the headset via Bluetooth connection.

Related Topic

- [What you can do with the “Sony | Headphones Connect” app](#)

Receiving a call

You can enjoy a hands-free call with a smartphone or mobile phone that supports the Bluetooth profile HFP (Hands-free Profile) or HSP (Headset Profile), via Bluetooth connection.

- If your smartphone or mobile phone supports both HFP and HSP, set it to HFP.
- The operation may vary depending on the smartphone or mobile phone. Refer to the operating instructions supplied with the smartphone or mobile phone.
- Depending on the connected device or the application you are using, the functions may not work properly even if you try to operate them with the headset.

Ring tone

When you receive an incoming call, a ring tone will be heard from the headset.

You will hear either of following ring tones, depending on your smartphone or mobile phone.

- Ring tone set on the headset
- Ring tone set on the smartphone or mobile phone
- Ring tone only for a Bluetooth connection set on the smartphone or mobile phone

1 Connect the headset to a smartphone or mobile phone via Bluetooth connection beforehand.

2 When you hear a ring tone, press the button on the left or right unit of the headset and receive the call.

A voice will be heard from the headset.

When you receive an incoming call while you are listening to music, playback pauses and a ring tone will be heard from the headset.

You can talk using the microphones on the headset.

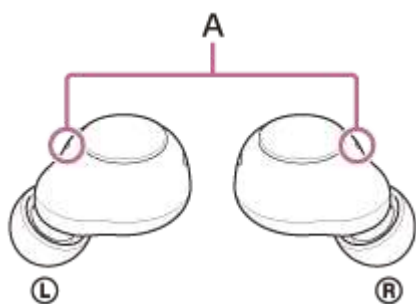
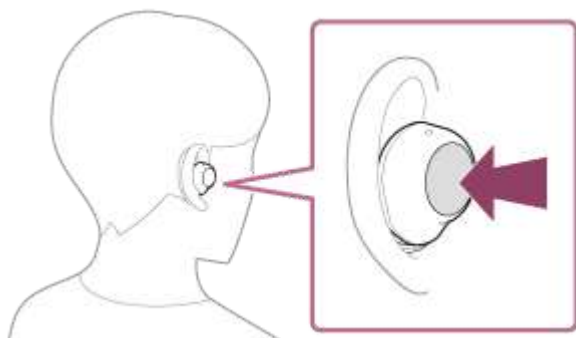

A: Microphones (left, right)

If no ring tone is heard via the headset

- The headset may not be connected with the smartphone or mobile phone over HFP or HSP. Check the connection status on the smartphone or mobile phone.
- If playback does not pause automatically, operate the headset to pause playback.

3 Operate the smartphone or mobile phone to adjust the volume.

4 When you finish talking, press the button on the left or right unit of the headset to end the call.

If you received a call during music playback, music playback resumes automatically after ending the call.

Hint

- When receiving a call by operating smartphones or mobile phones, some smartphones or mobile phones receive a call with the phone instead of the headset. With an HFP connection, switch the call to the headset by pressing and holding the button on the left or right unit for about 2 seconds or by using your smartphone or mobile phone.
- The headset volume during a call and during music playback can be independently adjusted. Even if you change the volume during a call, the volume of music playback does not change.
- You can also enjoy hands-free calls even when you are using only one unit of the headset. When you receive an incoming call, answer the call with the unit of the headset you are using. If you remove the other unit of the headset from the charging case while you are talking with only one unit, you can talk with both units.

Note

- Depending on the smartphone or mobile phone, when you receive an incoming call while you are listening to music, playback may not resume automatically even if you finish the call.
- Use a smartphone or mobile phone at least 50 cm (19.69 in.) away from the headset. Noise may result if the smartphone or mobile phone is too close to the headset.
- Your voice will be heard from the headset through the headset's microphone (Sidetone function). In this case, ambient sounds or the sounds of the headset operation may be heard through the headset, but this is not a malfunction.
- You cannot adjust the volume during a call on the headset. Adjust the volume on the connected device.
- When you are using only one unit of the headset, be sure to set the other unit in the charging case.

Related Topic

- [Using only one unit of the headset](#)
- [How to make a wireless connection to Bluetooth devices](#)
- [Making a call](#)
- [Functions for a phone call](#)
- [What you can do with the "Sony | Headphones Connect" app](#)

Making a call

You can enjoy a hands-free call with a smartphone or mobile phone that supports the Bluetooth profile HFP (Hands-free Profile) or HSP (Headset Profile), via Bluetooth connection.

- If your smartphone or mobile phone supports both HFP and HSP, set it to HFP.
- The operation may vary depending on the smartphone or mobile phone. Refer to the operating instructions supplied with the smartphone or mobile phone.
- Depending on the connected device or the application you are using, the functions may not work properly even if you try to operate them with the headset.

1 Connect the headset to a smartphone/mobile phone via Bluetooth connection.

2 Operate your smartphone or mobile phone to make a call.

When you make a call, the dial tone is heard from the headset.
If you make a call while you are listening to music, playback pauses.
You can talk using the microphones on the headset.

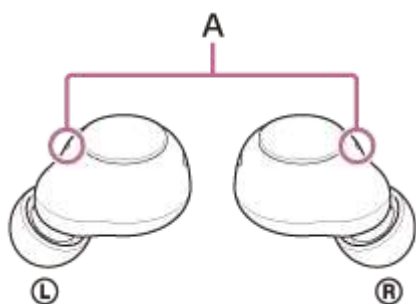

A: Microphones (left, right)

If no dial tone is heard via the headset

Use your smartphone or mobile phone to switch from the call device to the headset, or press and hold the button on either the left or right headset unit for about 2 seconds.

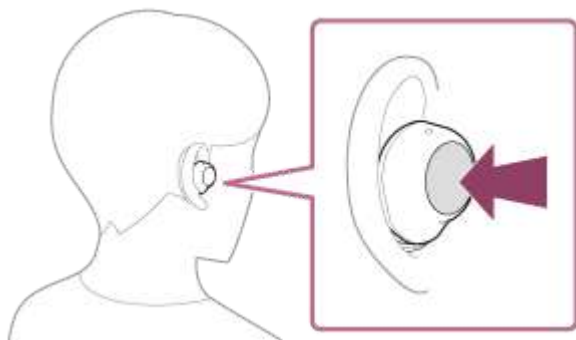

3 Operate the smartphone or mobile phone to adjust the volume.

4 When you finish talking, press the button on the left or right unit of the headset to end the call.

If you made a call during music playback, music playback resumes automatically after ending the call.

Hint

- The headset volume during a call and during music playback can be independently adjusted. Even if you change the volume during a call, the volume of music playback does not change.
- You can also enjoy hands-free calls even when you are using only one unit of the headset. If you remove the other unit of the headset from the charging case while you are talking with only one unit, you can talk with both units.

Note

- Use a smartphone or mobile phone at least 50 cm (19.69 in.) away from the headset. Noise may result if the smartphone or mobile phone is too close to the headset.
- Your voice will be heard from the headset through the headset's microphone (Sidetone function). In this case, ambient sounds or the sounds of the headset operation may be heard through the headset, but this is not a malfunction.
- You cannot adjust the volume during a call on the headset. Adjust the volume on the connected device.
- When you are using only one unit of the headset, be sure to set the other unit in the charging case.

Related Topic

- [Using only one unit of the headset](#)
- [How to make a wireless connection to Bluetooth devices](#)
- [Receiving a call](#)
- [Functions for a phone call](#)
- [What you can do with the "Sony | Headphones Connect" app](#)

Functions for a phone call

The functions available during a call may vary depending on the profile supported by your smartphone or mobile phone. In addition, even if the profile is the same, the available functions may vary depending on the smartphone or mobile phone.

Depending on the connected device or the application you are using, the functions may not work properly even if you try to operate them with the headset.

Refer to the operating instructions supplied with the smartphone or mobile phone.

Supported profile: HFP (Hands-free Profile)

During standby/music playback

- Press and hold the button on the right unit for about 2 seconds to start up the voice dial function of the smartphone/mobile phone, or activate the Google™ app on the Android smartphone or Siri on the iPhone.

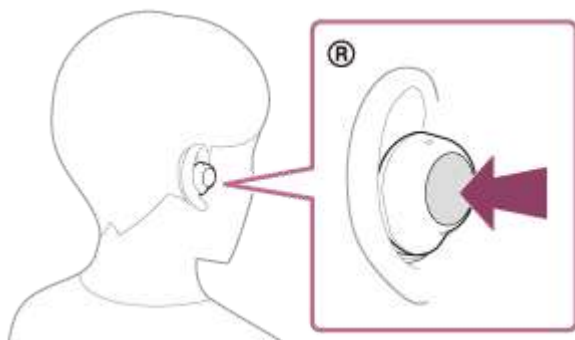

Outgoing call

You can use either the left or right unit to perform the following operations.

When using only one unit of the headset, operate the unit you are using.

- Press the button once to cancel an outgoing call.
- Press and hold the button for about 2 seconds to change the call device back and forth between the headset and the smartphone/mobile phone.

Incoming call

You can use either the left or right unit to perform the following operations.

When using only one unit of the headset, operate the unit you are using.

- Press the button once to answer a call.
- Press and hold the button for about 2 seconds to reject a call.

During call

You can use either the left or right unit to perform the following operations.

When using only one unit of the headset, operate the unit you are using.

- Press the button once to finish a call.
- Press and hold the button for about 2 seconds to change the call device back and forth between the headset and the smartphone/mobile phone.

Supported profile: HSP (Headset Profile)

You can use either the left or right unit to perform the following operations.

When using only one unit of the headset, operate the unit you are using.

Outgoing call

- Press the button once to cancel an outgoing call.

Incoming call

- Press the button once to answer a call.

During call

- Press the button once to finish a call.

Note

- When you are using only one unit of the headset, be sure to set the other unit in the charging case.

Related Topic

- [Using only one unit of the headset](#)
- [Receiving a call](#)
- [Making a call](#)

Making a video call on your computer

When you make a video call on your computer, you can talk wirelessly from your headset.

- 1 Connect the headset to your computer via Bluetooth connection.**
- 2 Launch the video calling application on your computer.**
- 3 Check the settings (*) of the video calling application.**
 - When you make a video call on your computer, select calling connections (HFP/HSP) and not music playback connections (A2DP). If you select music playback connections, a video call may not be available.
 - On the speaker settings, select calling connections [Headset (WF-C500 Hands-Free)] (**). ([Headphones (WF-C500 Stereo)] (**)) is for music playback connections.)
 - Depending on the video calling application you are using, calling connections [Headset (WF-C500 Hands-Free)] (**) or music playback connections [Headphones (WF-C500 Stereo)] (**)) may not be selectable on the speaker or microphone settings, and only [WF-C500] may be displayed. If this is the case, select [WF-C500].
 - As for frequently asked questions and answers, refer to the customer support website.

* Depending on the video calling application you are using, this function may not be available.

** Names may vary according to the computer or the video calling application you are using.

Hint

- When the settings of the video calling application cannot be checked or calling connections [Headset (WF-C500 Hands-Free)] cannot be selected, select [Headset (WF-C500 Hands-Free)] on the settings of your computer to make connections. See ["Pairing and connecting with a computer \(Windows® 10\)"](#), ["Pairing and connecting with a computer \(Windows 8.1\)"](#) or ["Pairing and connecting with a computer \(Mac\)"](#).

Related Topic

- [How to make a wireless connection to Bluetooth devices](#)
- [Pairing and connecting with a computer \(Windows® 10\)](#)
- [Pairing and connecting with a computer \(Windows 8.1\)](#)
- [Pairing and connecting with a computer \(Mac\)](#)
- [Connecting to a paired computer \(Windows 10\)](#)
- [Connecting to a paired computer \(Windows 8.1\)](#)
- [Connecting to a paired computer \(Mac\)](#)
- [Disconnecting Bluetooth connection \(after use\)](#)
- [Customer support websites](#)

Disconnecting Bluetooth connection (after use)

1 Disconnect the Bluetooth connection by operating the Bluetooth device.

You will hear the voice guidance say "Bluetooth disconnected" from the left or right unit of the headset.

2 Set the headset into the charging case.

The headset turns off.

Hint

- When you finish playing music, the Bluetooth connection may terminate automatically depending on the Bluetooth device.

Related Topic

- [Turning off the headset](#)

Using the voice assist function (Google app)

By using the Google app feature that comes with the Android smartphone, you can speak to the headset's microphones to operate the Android smartphone.

1 Set the assist and voice input selection to the Google app.

On the Android smartphone, select [Settings] - [Apps & notifications] - [Advanced] - [Default apps] - [Assist & voice input], and set [Assist app] to the Google app.

The operation above is an example. For details, refer to the operating instructions of the Android smartphone.

Note: The latest version of the Google app may be required.

For details on the Google app, refer to the operating instructions or the support website of the Android smartphone, or the Google Play store website.

The Google app may not be activated from the headset depending on specifications of the Android smartphone.

2 Put the headset units into your ears and connect the headset to the Android smartphone via Bluetooth connection.

3 When the Android smartphone is in standby or playing music, press and hold the button on the right unit for about 2 seconds.

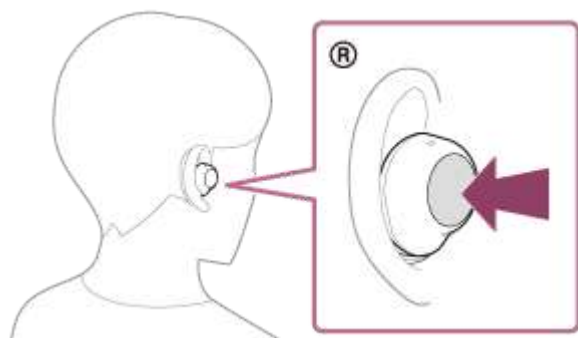

The Google app is activated.

4 Make a request to the Google app through the headset's microphones.

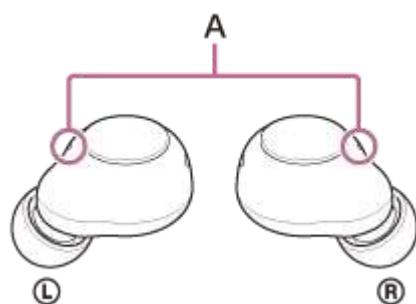

A: Microphones (left, right)

For details on the apps which work with the Google app, refer to the operating instructions of the Android smartphone.

After activating the Google app, the voice command is canceled when a certain time has passed without requests.

Note

- The Google app cannot be activated when you say “Ok Google” even when the Android smartphone’s “Ok Google” setting is on.
- When using the voice assist function, your voice will be heard from the headset through the headset’s microphones (Sidetone function). In this case, ambient sounds or the sounds of the headset operation may be heard through the headset, but this is not a malfunction.
- The Google app may not be activated depending on specifications of the smartphone or application version.
- The Google app does not work when connected to a device not compatible with the voice assist function.

Using the voice assist function (Siri)

By using the Siri feature that comes with iPhone, you can speak to the headset's microphones to operate the iPhone.

1 Turn Siri on.

On iPhone, select [Settings] - [Siri & Search] to turn [Press Home for Siri] and [Allow Siri When Locked] on. The operation above is an example. For details, refer to the operating instructions of the iPhone.
Note: For details on Siri, refer to the operating instructions or support website of the iPhone.

2 Put the headset units into your ears and connect the headset to the iPhone via Bluetooth connection.

3 When the iPhone is in standby or playing music, press and hold the button on the right unit until Siri is activated.

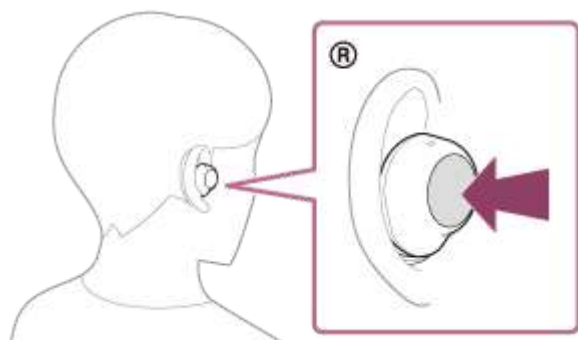

Siri is activated.

4 Make a request to Siri through the headset's microphones.

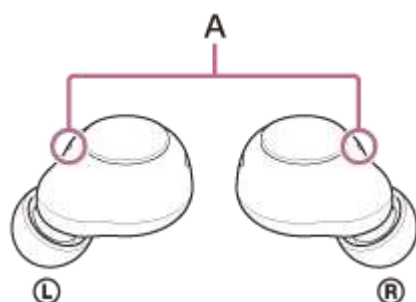

A: Microphones (left, right)

For details on the apps which work with Siri, refer to the operating instructions of the iPhone.

Note

- Siri cannot be activated when you say "Hey Siri" even when the iPhone's "Hey Siri" setting is on.
- When using the voice assist function, your voice will be heard from the headset through the headset's microphones (Sidetone function). In this case, ambient sounds or the sounds of the headset operation may be heard through the headset, but this is not a malfunction.

- Siri may not be activated depending on specifications of the smartphone or application version.

5-030-793-11(2) Copyright 2021 Sony Corporation

Wireless Stereo Headset
WF-C500

What you can do with the “Sony | Headphones Connect” app

When you connect the smartphone with the “Sony | Headphones Connect” app installed and the headset via Bluetooth connection, you can do the following.

- Update the headset software
- Switch the voice guidance language
- Turn the voice guidance on/off
- Set the Bluetooth connection mode (sound quality mode)
- Turn off the headset
- Check the headset software version
- Display the Bluetooth connection codec
- Display the DSEE (completion for high-range sound) function setting status
- Display the remaining battery charge of the headset
- Select the Equalizer/CLEAR BASS setting
- Customize the Equalizer setting
- Set the DSEE (completion for high-range sound) function
- Play/pause music, skip to the beginning of the previous track (or the current track during playback)/skip to the beginning of the next track
- Adjust the volume during music playback/phone call
- Easy pairing

For details on the “Sony | Headphones Connect” app, refer to the following URL.

https://rd1.sony.net/help/mdr/hpc/h_zz/

Hint

- The operation of the “Sony | Headphones Connect” app differs depending on the audio device. The app specifications and screen design may change without prior notice.

Related Topic

- [Installing the “Sony | Headphones Connect” app](#)
- [About the voice guidance](#)
- [About the sound quality mode](#)
- [Wearing the headset](#)
- [Supported codecs](#)
- [Checking the remaining battery charge](#)
- [About the DSEE function](#)

Wireless Stereo Headset
WF-C500

Installing the “Sony | Headphones Connect” app

- 1 Download the “Sony | Headphones Connect” app from the Google Play store or App Store, and install the app on your smartphone.

For details on the “Sony | Headphones Connect” app, refer to the following URL.

https://rd1.sony.net/help/mdr/hpc/h_zz/



Sony Headphones Connect 

- 2 After installing the app, launch the “Sony | Headphones Connect” app.
-

Related Topic

- [What you can do with the “Sony | Headphones Connect” app](#)

Wireless Stereo Headset
WF-C500

Accessing support information from the “Sony | Headphones Connect” app

You can access the latest support information from the “Sony | Headphones Connect” app.

- 1 Select [Help] on the “Sony | Headphones Connect” app screen.
- 2 The [Headphones Connect Help] screen appears and support information is displayed.
- 3 Select the desired item.

How to keep the software up-to-date (for comfortable use of the headset)

If your headset has the latest software, a notification will appear on the screen of the “Sony | Headphones Connect” app. Update the headset software following the on-screen instructions.

Install the latest headset software to enjoy new functions or to resolve a certain number of issues with the headset. Always use the headset with the latest software installed.

For details on the latest headset software and how to update the software, refer to the information on the support website.

Note

- When the mobile device used for the update has any other Bluetooth devices connected to it, turn off all the Bluetooth devices until the update is complete.
Software may not be updated when the mobile device is connected with other devices compatible with Bluetooth Low Energy (such as wearable devices, smart watches, etc.).
- Note the following if the update cannot be completed.
 - Close all the apps installed on the mobile device except the “Sony | Headphones Connect” app.
 - Fully charge the headset and the mobile device.
 - Put the headset and the mobile device being used for the update as close to each other as possible before starting the update.
 - Do not start the update if there are wireless LAN devices or other Bluetooth devices nearby.
 - Turn off the power saving mode (*) of your smartphone before updating the software.
Depending on the OS version of your smartphone, the update may not be completed under the power saving mode.

* Names may vary according to the smartphone you are using.

Related Topic

- [What you can do with the “Sony | Headphones Connect” app](#)

Precautions

On Bluetooth communications

- Bluetooth wireless technology operates within a range of about 10 m (30 feet). The maximum communication distance may vary depending on the presence of obstacles (people, metal objects, walls, etc.) or the electromagnetic environment.
- Microwaves emitting from a Bluetooth device may affect the operation of electronic medical devices. Turn off the headset and other Bluetooth devices in the following locations, as it may cause an accident:
 - in hospitals, near priority seating in trains, locations where inflammable gas is present, near automatic doors, or near fire alarms.
- This product emits radio waves when used in wireless mode. When used in wireless mode on an airplane, follow flight crew directions regarding permissible use of products in wireless mode.
- The audio playback on the headset may be delayed from that on the transmitting device, due to the characteristics of Bluetooth wireless technology. As a result, the sound may not be in sync with the image when viewing movies or playing games.
- The headset supports security functions that comply with the Bluetooth standard as a means of ensuring security during communication using Bluetooth wireless technology. However, depending on the configured settings and other factors, this security may not be sufficient. Be careful when communicating using Bluetooth wireless technology.
- Sony shall assume no responsibility for any damages or loss resulting from information leaks that occur when using Bluetooth communications.
- Bluetooth connections with all Bluetooth devices cannot be guaranteed.
 - Bluetooth devices connected with the headset must comply with the Bluetooth standard prescribed by Bluetooth SIG, Inc., and must be certified as compliant.
 - Even when a connected device complies with the Bluetooth standard, there may be cases where the characteristics or specifications of the Bluetooth device make it unable to connect, or result in different control methods, display, or operation.
 - When using the headset to perform hands-free talking on the phone, noise may occur depending on the connected device or the communication environment.
- Depending on the device to be connected, it may require some time to start communications.
- The headset does not support multipoint connection.

With multipoint function support, the headset can connect to a music playback device (A2DP profile, Walkman®, etc.) and a communication device (HFP or HSP profile, smartphone, etc.) at the same time, and you can listen to music while waiting for an incoming call or making a call.

Note on temperature rise

- While charging the headset or charging case, or when using the headset for a long time, the temperature of the headset or charging case may rise, but this is not a malfunction.

Note on static electricity

- If you use the headset when the air is dry, you may experience discomfort due to static electricity accumulated on your body. This is not a malfunction of the headset. You can reduce the effect by wearing clothes made of natural materials that do not easily generate static electricity.

Notes on wearing the headset

- After use, remove the headset from your ears slowly.
- Because the headset achieves a tight seal over the ears, forcibly pressing it against your ears or quickly pulling it off can result in eardrum damage. When wearing the headset, the speaker diaphragm may produce a click sound. This

is not a malfunction.

- The long-term use of the headset may cause symptoms such as itching and irritation in the ears. If you experience any of the above symptoms while using the headset, stop using it immediately and consult a doctor or your nearest Sony dealer.
- For long-term use, it is recommended that you remove the headset from your ears on a regular basis.

Other notes

- Do not subject the headset to excessive shock as it is a precision device.
- The Bluetooth function may not work with a mobile phone, depending on the signal conditions and the surrounding environment.
- If you experience discomfort while using the headset, stop using it immediately.
- The earbud tips may be damaged or deteriorate with long-term use and storage.
- If the earbud tips become dirty, remove them from the headset and gently wash them by hand using a neutral detergent. After cleaning, thoroughly wipe off any moisture.
- If water or foreign matter enters the headset, it may result in fire or electric shock. If water or foreign matter enters the headset, stop use immediately and consult your nearest Sony dealer. In particular, be careful in the following cases.
 - When using the headset near a sink or liquid container
Be careful that the headset does not fall into a sink or container filled with water.
 - When using the headset in the rain or snow, or in humid locations

Cleaning the headset

- When the headset exterior is dirty, wipe it clean with a soft dry cloth. If the headset is particularly dirty, soak a cloth in diluted neutral detergent, and wring it well before using it to clean the headset. Do not use solvents such as thinner, benzene, or alcohol, as they may damage the surface.

Do not use the headset near medical devices

- Radio waves can affect cardiac pacemakers and medical devices. Do not use the headset in crowded places such as crowded trains or inside a medical institution.
- The headset (including accessories) has magnet(s) which may interfere with pacemakers, programmable shunt valves for hydrocephalus treatment, or other medical devices. Do not place the headset close to persons who use such medical devices. Consult your doctor before using the headset if you use any such medical device.

Keep the headset units and charging case away from the magnetic card

- The headset units and charging case use magnets. If you bring a magnetic card close to the headset, the card magnet may be affected and become unusable.

To prevent burning or malfunction due to getting wet

Be sure to clean after use

Charging with liquid such as water or sweat or foreign objects such as dust attached to the USB Type-C port of the charging case or charging port of the headset may cause an accident such as burns or serious wounds due to fire, electrocution, heat generation, smoke, or ignition. It may also cause a malfunction.

Avoid the following situations and be careful not to get moisture or dirt on the headset or charging case.

If the headset or charging case gets wet or dirty, see [“When the headset or charging case gets wet”](#) and clean them as described before use.

- Touching the headset or charging case without wiping your wet hands after doing housework in a kitchen or washing your hands in a washroom.



- Putting the headset or charging case in the chest pocket of a damp article of clothing.



- Putting the headset or charging case in a bag with a cold PET bottle.



- Spilling a drink while eating or drinking.



5-030-793-11(2) Copyright 2021 Sony Corporation

When the headset or charging case gets wet

On water resistant performance of the headset

- The charging case is not water resistant.
- The water resistant specifications of this headset are equivalent to IPX4 in IEC 60529 “Degrees of protection against ingress of water (IP Code)”, which specifies the degree of protection provided against the entry of water. The headset cannot be used in water.

Unless the headset is used correctly, water may get into the headset and cause fire, electrocution, or malfunctions.

Note the following cautions carefully and use the headset correctly.

IPX4: Protected against water splashing from any direction.

- The sound conduits (sound output tubes), air holes and microphone hole of the headset are not completely watertight.

If any water droplets are left in the sound conduits, air holes or microphone hole, the following issues may occur temporarily, but they are not malfunctions.

- Sounds become difficult to hear.
- Unusual sounds are heard.
- Voices during phone calls become difficult to hear.

Liquids that the water resistant performance specifications of the headset apply to

Applicable:	Fresh water, tap water, perspiration
Not applicable:	Liquids other than those above (examples: soapy water, detergent water, water with bath agents, shampoo, hot spring water, hot water, pool water, seawater, etc.)

The water resistant performance of the headset is based on measurements performed by Sony under the conditions described above. Note that malfunctions resulting from water immersion caused by customer misuse are not covered by the warranty.

To protect the headset and charging case from being damaged

Carefully note the precautions below to ensure proper use of the headset.

- Do not splash water forcibly into the sound output part or microphone of the headset.
- Do not allow the headset to remain wet in a cold environment, as the water may freeze. To prevent malfunction, make sure to wipe off any water after use.
- Do not place the headset in water or use it in a humid place such as a bathroom.
- Do not drop the headset or expose it to mechanical shock. Doing so may deform or damage the headset, resulting in deterioration of water resistance performance.
- If the headset gets wet,
 1. Use a soft dry cloth to wipe off any water that gets on the headset.
 2. Remove the earbud tips, turn the sound conduits and the air holes downward, and shake several times to get the water out.



3. Turn the microphone hole downward and gently tap it about 5 times on a dry cloth, etc. to remove any water collected inside.



4. Leave the headset to dry in room temperature.

- If the headset units and charging case are charged while they are wet with sweat, etc., the charging ports will corrode. Before charging, wipe off any moisture with a soft dry cloth and leave to dry in room temperature. Repairs in case of a malfunction without care are not covered by the free warranty.

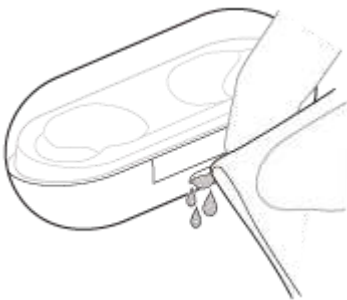

- When the charging ports of the headset or charging case get dirty, wipe them clean with a soft dry cloth.
- Do not wash pants or shirts with the headset units left in the pockets.



- If the headset is cracked or deformed, refrain from using the headset near water, or contact your nearest Sony dealer.

5-030-793-11(2) Copyright 2021 Sony Corporation

Wireless Stereo Headset
WF-C500

License notice

Notes on the License

This product contains software that Sony uses under a licensing agreement with the owner of its copyright. We are obligated to announce the contents of the agreement to customers under requirement by the owner of copyright for the software.

Please read the contents of the license.

Access the following URL for the contents of the license.

<https://rd1.sony.net/help/mdr/sl/21/>

Disclaimer regarding services offered by third parties

Services offered by third parties may be changed, suspended, or terminated without prior notice. Sony does not bear any responsibility in these sorts of situations.

Wireless Stereo Headset
WF-C500

Trademarks

- Windows is a registered trademark or trademark of Microsoft Corporation in the United States and/or other countries.
- iPhone, iPod touch, macOS, Mac and Siri are trademarks of Apple Inc., registered in the U.S. and other countries.
- App Store is a service mark of Apple Inc., registered in the U.S. and other countries.
- IOS is a trademark or registered trademark of Cisco in the U.S. and other countries and is used under license.
- Google, Android and Google Play are trademarks of Google LLC.
- The Bluetooth® word mark and logos are registered trademarks owned by Bluetooth SIG, Inc. and any use of such marks by Sony Group Corporation and its subsidiaries is under license.
- USB Type-C® and USB-C® are registered trademarks of USB Implementers Forum.
- “DSEE” is a trademark of Sony Corporation.

The system names and product names indicated in this Help Guide are generally the trademarks or registered trademarks of the manufacturer.

Wireless Stereo Headset
WF-C500

Customer support websites

For customers in the U.S.A, Canada, and Latin America:

<https://www.sony.com/am/support>

For customers in European countries:

<https://www.sony.eu/support>

For customers in China:

<https://service.sony.com.cn>

For customers in other countries/regions:

<https://www.sony-asia.com/support>

What can I do to solve a problem?

If the headset does not function as expected, try the following steps to resolve the issue.

- Find the symptoms of the issue in this Help Guide, and try any corrective actions listed.
- Set the headset into the charging case.
You may be able to resolve some issues by setting the headset into the charging case.
- Charge the headset.
You may be able to resolve some issues by charging the headset battery.
- Restart the device that is being connected to the headset.
You may be able to resolve some issues by restarting the device being connected such as your computer or smartphone.
- Reset the headset.
- Initialize the headset.
This operation resets volume settings, etc. to the factory settings, and deletes all pairing information.
- Look up information on the issue on the customer support website.

If the operations above do not work, consult your nearest Sony dealer.

Related Topic

- [Charging](#)
- [Customer support websites](#)
- [Resetting the headset](#)
- [Initializing the headset to restore factory settings](#)

Wireless Stereo Headset
WF-C500

Unable to turn on the headset.

- Make sure the battery is fully charged.
 - You cannot turn on the headset when the headset is placed and being charged in the charging case. Remove the headset from the charging case to turn it on.
 - Charge the charging case.
 - Set the headset into the charging case.
You may be able to resolve some issues by setting the headset into the charging case.
 - Reset the headset.
 - Initialize the headset, and pair the headset and the device again.
-

Related Topic

- [Charging](#)
- [Checking the remaining battery charge](#)
- [Resetting the headset](#)
- [Initializing the headset to restore factory settings](#)

Charging cannot be done.

Common

- Make sure the headset is set securely in the charging case.
- Make sure to set the left and right headset units correctly in the charging case.
- Be sure to use the supplied USB Type-C cable and check that the cable is firmly connected to the charging case.
- If the earbud tips are not properly attached to the headset, the headset may not be charged with the supplied charging case. Check that the earbud tips are attached properly when you store the headset in the charging case.
- If earbud tips by other manufacturers are used, the headset may not be charged with the supplied charging case. Be sure to use the supplied earbud tips when charging.
- When the charging ports of the headset or the charging case get dirty, the headset may not be charged. Clean the charging ports with a soft dry cloth.
- It is recommended to charge in a place with an ambient temperature between 15 °C and 35 °C (59 °F - 95 °F). Efficient charging may not be possible beyond this range.
- Reset the headset.
- Initialize the headset, and pair the headset and the device again.

When charging with a USB AC adaptor

- Make sure that the USB AC adaptor is firmly connected to the AC outlet.
- When using a commercially available USB AC adaptor, use one capable of supplying an output current of 0.5 A (500 mA) or more.
- If the indicator (orange) on the charging case flashes while charging by connecting the charging case to the USB AC adaptor with the supplied USB Type-C cable, check the ambient temperature, disconnect the cable and connect again.

When charging with a computer

- Check that the USB Type-C cable is firmly connected to the computer.
- Check that the computer is turned on. Wake the computer up if the computer is in standby (sleep) or hibernation mode.
- Check that the charging case and the computer are directly connected and not via a USB hub.
- There may be a problem with the USB port of the connected computer. Try connecting to another USB port on the computer if one is available.
- Update the OS of the computer.

Related Topic

- [Charging](#)
- [Replacing the earbud tips](#)
- [Resetting the headset](#)
- [Initializing the headset to restore factory settings](#)

The available operating time is short, the battery power does not last long.

- If you set the following functions, the available operating time of the battery becomes short.
 - Equalizer
 - DSEE
 - Sound quality mode during Bluetooth playback: Priority on sound quality

If you set the equalizer and DSEE at the same time, the available operating time of the battery becomes even shorter.

- Depending on the settings for the headset functions and the usage conditions, the speed of energy consumption for the battery may vary between the left and right units, but this is not a malfunction.
- When you have finished using the headset, be sure to set the headset in the charging case. When the headset is left removed, the headset will not turn off until 15 minutes have passed after disconnecting the Bluetooth connection.
- When talking on the phone, the available operating time of the battery is shorter than when playing music.

Related Topic

- [Available operating time](#)

Charging time is too long.

- When charging with a computer, check that the charging case and the computer are directly connected and not via a USB hub. Also, this may be improved by restarting the computer and trying the USB connection again.
 - Check that you are using the supplied USB Type-C cable.
 - Depending on the settings for the headset functions and the usage conditions, the speed of energy consumption for the battery may vary between the left and right units.
As a result, the charging time of the batteries may differ between the left and right units, but this is not a malfunction.
 - It is recommended to charge in a place with an ambient temperature between 15 °C and 35 °C (59 °F - 95 °F).
Efficient charging may not be possible beyond this range.
 - When using a commercially available USB AC adaptor, use one capable of supplying an output current of 0.5 A (500 mA) or more.
-

Related Topic

- [Charging](#)
- [Resetting the headset](#)
- [Initializing the headset to restore factory settings](#)

No sound, no sound from one side

Common

- Pair the headset and the Bluetooth device again.
- Charge the charging case.
- Set the headset into the charging case.
You may be able to resolve some issues by setting the headset into the charging case.
- Restart the smartphone or the computer you use.
- Reset the headset.
- Initialize the headset, and pair the headset and the device again.

When connecting to a computer

- If you are connecting a computer to the headset, make sure the audio output setting of the computer is set for a Bluetooth device.

When there is no sound on only one side

- Depending on the smartphone app or computer application (which requires HFP (Hands-free Profile)/HSP (Headset Profile)), you may hear a voice from only one unit.

Related Topic

- [Using only one unit of the headset](#)
- [How to make a wireless connection to Bluetooth devices](#)
- [Listening to music from a device via Bluetooth connection](#)
- [Resetting the headset](#)
- [Initializing the headset to restore factory settings](#)

Low sound level

- If the size of the earbud tips does not match the size of your ear canals or the headset is not worn properly in your ears, you may not obtain the correct sound qualities or volume.
If any of this is the case, try the following.
 - Change the earbud tips to ones that fit more snugly in your ears. When changing the earbud tips, try the earbud tip sizes in order from the larger ones to the smaller ones. The size of the left and right earbud tips may be different.
 - Check that you are wearing the headset properly in your ears. Wear the headset so that the earbud tip is comfortably situated as deep in the ear canal as possible.
- Turn up the volume of the connected device.
- You can adjust the volume on the headset during music playback.
- You cannot adjust the volume during a call on the headset. Adjust the volume on the connected device.
- Connect the Bluetooth device to the headset once again.
- The sound conduits (sound output tubes), air holes and microphone hole of the headset are not completely watertight. If any water droplets are left in the sound conduits, air holes or microphone hole, the sound level becomes low temporarily, but this is not a malfunction. See “[When you have finished using the headset](#)” and dry the headset as described before use.
- Set the headset into the charging case.
You may be able to resolve some issues by setting the headset into the charging case.
- Reset the headset.
- Initialize the headset, and pair the headset and the device again.

Note

- Depending on the connected device, the volume of the device and the headset may or may not be synced. If the volume on a device is not synced to the volume on the headset, it will not be possible to use the device to turn up the volume on the headset once the volume is turned down on the headset.
If the sound is still low even after adjusting the volume on the connected device, adjust the volume with the “Sony | Headphones Connect” app.

Related Topic

- [Wearing the headset](#)
- [Resetting the headset](#)
- [Initializing the headset to restore factory settings](#)

Low sound quality

- If the size of the earbud tips does not match the size of your ear canals or the headset is not worn properly in your ears, you may not obtain the correct sound qualities or call performance.
If any of this is the case, try the following.
 - Change the earbud tips to ones that fit more snugly in your ears. When changing the earbud tips, try the earbud tip sizes in order from the larger ones to the smaller ones. The size of the left and right earbud tips may be different.
 - Check that you are wearing the headset properly in your ears. Wear the headset so that the earbud tip is comfortably situated as deep in the ear canal as possible.
 - Turn down the volume of the connected device if it is too loud.
 - Switch the Bluetooth connection to A2DP with the connected device when the headset and the transmitting Bluetooth device are connected via an HFP or HSP Bluetooth connection.
 - If you connect the headset to the previously connected Bluetooth device, the headset may only establish the HFP/HSP Bluetooth connection when it is turned on. Use the connected device to connect via an A2DP Bluetooth connection.
 - When listening to music from a computer on the headset, the sound quality may be poor (e.g., difficult to hear the singer's voice, etc.) for the first few seconds after a connection is established. This is due to the computer specifications (priority on stable connection at the start of transmission and then switches to priority on sound quality several seconds later) and is not a headset malfunction.
If the sound quality does not improve after a few seconds, use the computer to establish an A2DP connection. As for the operations on your computer, refer to the operating instructions supplied with the computer.
-

Related Topic

- [Wearing the headset](#)
- [Replacing the earbud tips](#)

Sound skips frequently.

- Set the headset to “Priority on stable connection mode”. For details, see “[About the sound quality mode](#)”.
- The situation may be improved by changing the wireless playback quality settings on the transmitting device. For details, refer to the operating instructions supplied with the transmitting device.
- Remove any obstacles between the antenna of the connecting Bluetooth device and the antennas built into the left and right units of the headset. The antenna of each left or right unit of the headset is built into the part shown in the dotted line below.

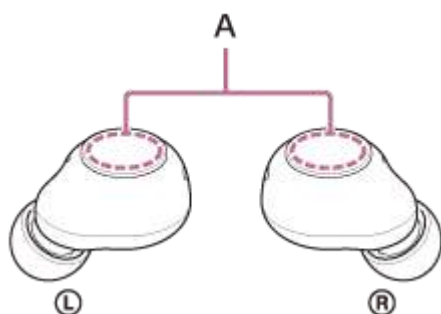

A: Locations of the built-in antennas (left, right)

- Bluetooth communications may be disabled, or noise or audio dropout may occur under the following conditions.
 - When there is a human body between the headset and the Bluetooth device
In this case, put the Bluetooth device in the same direction as the antenna of the headset to improve the Bluetooth communications.
 - When there is an obstacle, such as metal or a wall, between the headset and the Bluetooth device
 - In places with wireless LAN, where a microwave oven is used, electromagnetic waves are generated, etc.
 - Where there are other wireless communication audio devices or other people nearby, such as in train station premises or on a crowded train
- If you are enjoying music with your smartphone, the situation may be improved by shutting down unnecessary apps or restarting your smartphone. If you are enjoying music with your computer, close unnecessary applications or windows and restart the computer.
- Connect the headset and the Bluetooth device once again.
Set the headset into the charging case, and then remove the headset from the charging case to connect the headset to the Bluetooth device.
- Reset the headset.
- Initialize the headset, and pair the headset and the device again.

Related Topic

- [About the sound quality mode](#)
- [Resetting the headset](#)
- [Initializing the headset to restore factory settings](#)

Noise is heard during music playback.

- When you use the headset while you are walking or running, the sound of vibrations may be heard through your body, but this is due to the characteristics of the product and not a malfunction.
- The sound conduits (sound output tubes), air holes and microphone hole of the headset are not completely watertight. If any water droplets are left in the sound conduits, air holes or microphone hole, a beeping sound (feedback) may be heard temporarily. This is not a malfunction. See [“When you have finished using the headset”](#) and dry the headset as described before use.
- If you cover the microphones of the left or right unit of the headset, or if you grasp the headset unit in your hand, a beeping sound (feedback) may be heard. This is not a malfunction. If any of this is the case, remove your hands, etc. from the left and right microphones.
- Charge the charging case.
- Set the headset into the charging case.
You may be able to resolve some issues by setting the headset into the charging case.
- Reset the headset.
- Initialize the headset, and pair the headset and the device again.

Pairing cannot be done.

- Bring the headset and the Bluetooth device within 1 m (3 feet) from each other.
 - When pairing for the first time after purchasing, initializing, or repairing the headset, the headset enters pairing mode automatically if you remove the headset from the charging case. To pair a second or subsequent device, press and hold the buttons on both the left and right units at the same time for about 5 seconds to enter pairing mode.
 - When pairing a device once again after initializing or repairing the headset, you may be unable to pair the device if it retains pairing information for the headset (iPhone or other device). In this case, delete the pairing information for the headset from the device and pair them again.
 - Restart the connected device such as a smartphone or a computer you use, and pair the headset and the device again.
 - Set the headset into the charging case.
You may be able to resolve some issues by setting the headset into the charging case.
 - Reset the headset.
 - Initialize the headset, and pair the headset and the device again.
-

Related Topic

- [How to make a wireless connection to Bluetooth devices](#)
- [Resetting the headset](#)
- [Initializing the headset to restore factory settings](#)

Wireless Stereo Headset
WF-C500

Unable to make a Bluetooth connection.

- Check that the headset is turned on.
 - Check that the Bluetooth device is turned on and the Bluetooth function is on.
 - If the headset automatically connects to the last connected Bluetooth device, you may fail to connect the headset to other devices via Bluetooth connection. If this is the case, operate the last connected Bluetooth device and disconnect the Bluetooth connection.
 - Check if the Bluetooth device is in sleep mode. If the device is in sleep mode, cancel the sleep mode.
 - Check if the Bluetooth connection has been terminated. If terminated, make the Bluetooth connection again.
 - If the pairing information for the headset has been deleted on the Bluetooth device, pair the headset with the device again.
 - Set the headset into the charging case.
You may be able to resolve some issues by setting the headset into the charging case.
 - Reset the headset.
 - Initialize the headset, and pair the headset and the device again.
-

Related Topic

- [How to make a wireless connection to Bluetooth devices](#)
- [Resetting the headset](#)
- [Initializing the headset to restore factory settings](#)

Wireless Stereo Headset
WF-C500

The headset does not operate properly.

- Charge the charging case.
 - Set the headset into the charging case.
You may be able to resolve some issues by setting the headset into the charging case.
 - Reset the headset.
 - Initialize the headset, and pair the headset and the device again.
-

Related Topic

- [Resetting the headset](#)
- [Initializing the headset to restore factory settings](#)

Cannot hear a person during a call/low voice from callers, your voice does not reach the person during a call/your voice is low on the caller's side.

- Check that both the headset and the connected device are turned on.
- Turn up the volume of the connected device if it is too low.
- When you use the video calling application, open the settings (*) of the video calling application, and check that the speaker or microphone setting is specified as [Headset (WF-C500 Hands-Free)](**). When the settings of the video calling application cannot be checked or calling connections [Headset (WF-C500 Hands-Free)] cannot be selected, select [Headset (WF-C500 Hands-Free)] on the settings of your computer to make connections.

* Depending on the video calling application you are using, this function may not be available.

** Names may vary according to the computer or the video calling application you are using.

- If the size of the earbud tips does not match the size of your ear canals or the headset is not worn properly in your ears, you may not obtain the correct sound qualities or call performance.
If any of this is the case, try the following.
 - Change the earbud tips to ones that fit more snugly in your ears. When changing the earbud tips, try the earbud tip sizes in order from the larger ones to the smaller ones. The size of the left and right earbud tips may be different.
 - Check that you are wearing the headset properly in your ears. Wear the headset so that the earbud tip is comfortably situated as deep in the ear canal as possible.
 - Set the headset into the charging case. Then, take out the headset, and reconnect with the Bluetooth device.
 - Restart the Bluetooth device such as your smartphone or computer, and reconnect with the headset.
 - Set the headset into the charging case.
You may be able to resolve some issues by setting the headset into the charging case.
 - Reset the headset.
 - Initialize the headset, and pair the headset and the device again.
-

Related Topic

- [How to make a wireless connection to Bluetooth devices](#)
- [Receiving a call](#)
- [Making a call](#)
- [Wearing the headset](#)
- [Replacing the earbud tips](#)
- [Resetting the headset](#)
- [Initializing the headset to restore factory settings](#)

Wireless Stereo Headset
WF-C500

Earbud tips are damaged or lost.

- To change the earbud tips with new ones, purchase the EP-EX11 series (*) (sold separately).

* May not be supported in some countries or regions.

Wireless Stereo Headset
WF-C500

An earache occurs

- Change the earbud tips to ones that fit more snugly in your ears. When changing the earbud tips, try the earbud tip sizes in order from the larger ones to the smaller ones. The size of the left and right earbud tips may be different.
 - Check that you are wearing the headset properly in your ears.
 - If you wear the headset for a long time, your ears may start hurting. Use the headset while taking breaks periodically.
-
-

Related Topic

- [Replacing the earbud tips](#)
- [Wearing the headset](#)

Resetting the headset

If the headset cannot be turned on or cannot be operated even when it is turned on, reset the headset. Reset one of the headset units at a time.

- 1 Press and hold the button on the left unit for about 20 seconds.**

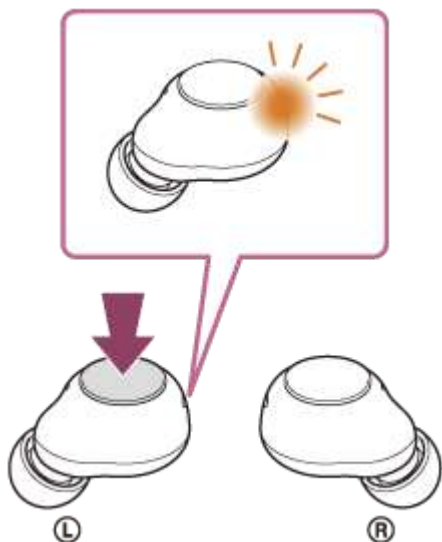

In about 15 seconds after you start pressing the button, the indicator (orange) on the left unit flashes slowly for about 5 seconds. Keep pressing and holding the button.

- 2 Check that the indicator turns off and then release your finger.**

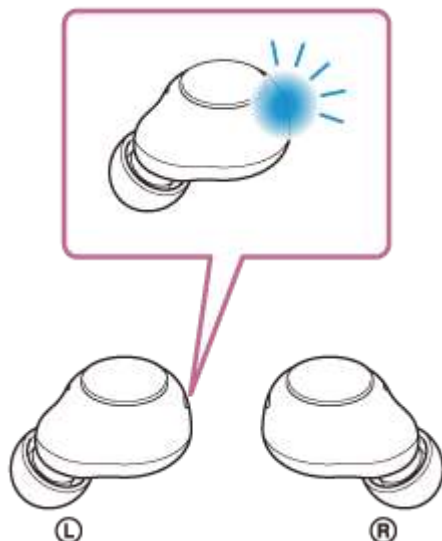

The left unit of the headset will be reset and restarted.
Check that the indicator (blue) on the left unit of the headset flashes twice.

- 3 Press and hold the button on the right unit for about 20 seconds.**

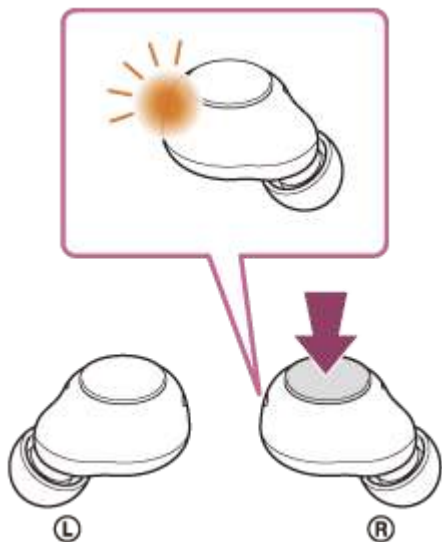

In about 15 seconds after you start pressing the button, the indicator (orange) on the right unit flashes slowly for about 5 seconds. Keep pressing and holding the button.

4 Check that the indicator turns off and then release your finger.

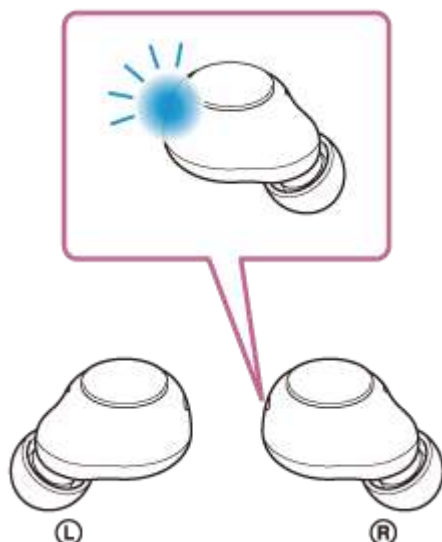

The right unit of the headset will be reset and restarted.
Check that the indicator (blue) on the right unit of the headset flashes twice.

The device registration (pairing) information and other settings are retained.
If the headset does not operate correctly even after resetting, initialize the headset to restore factory settings.

About the instruction manual video

Watch the video to find out how to reset.
https://rd1.sony.net/help/mdr/mov0029/h_zz/

Related Topic

- [Initializing the headset to restore factory settings](#)

Initializing the headset to restore factory settings

If the headset does not operate correctly even after resetting, initialize the headset.

- 1 Press and hold the buttons on both the left and right units of the headset for about 15 seconds.**

The indicators (blue) on the headset repeatedly flash twice in a row, and then the indicators (orange) start flashing.

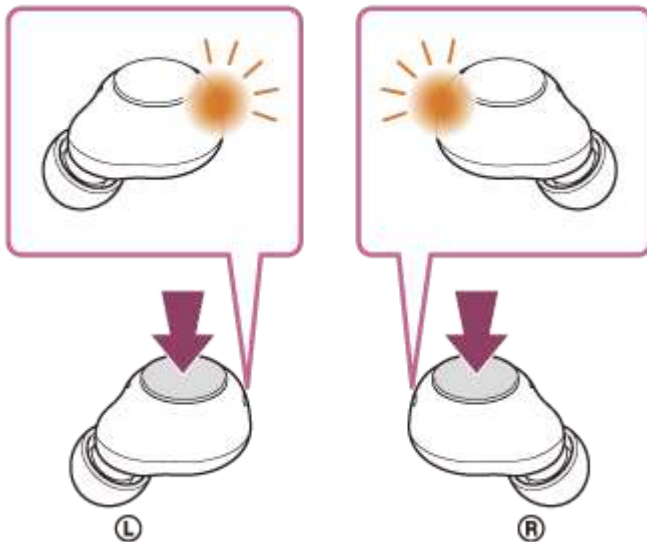

- 2 Release your fingers within 5 seconds after the indicators start flashing.**

The indicators (orange) on the headset light up.

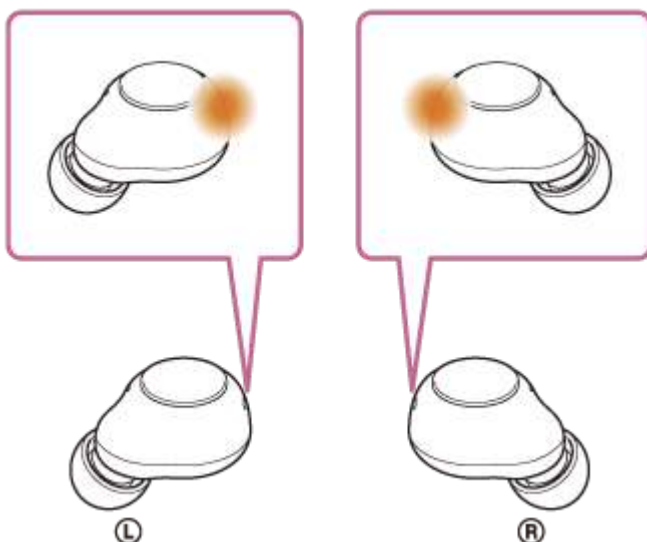

- 3 Press and hold the buttons on both the left and right units of the headset within 10 seconds after the indicators on the headset light up.**

After a few seconds, the indicators (blue) on the headset flash 4 times.

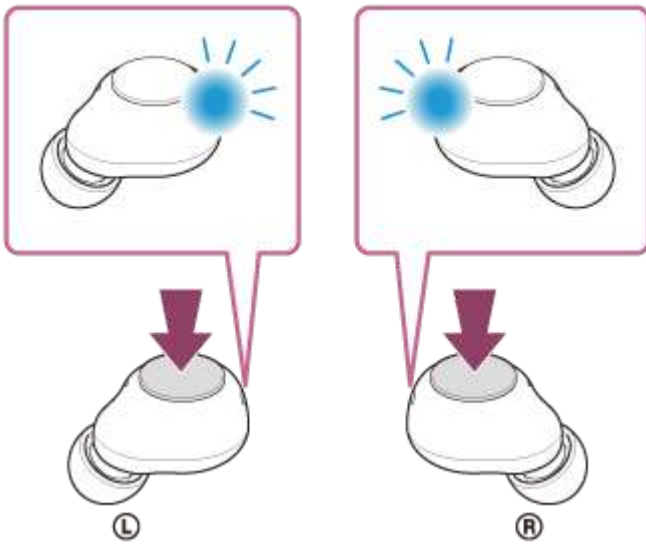

The headset is initialized.

This operation resets volume settings, etc. to the factory settings, and deletes all pairing information. In this case, delete the pairing information for the headset from the connected device and then pair them again. If the headset does not operate correctly even after initializing, consult your nearest Sony dealer.

About the instruction manual video

Watch the video to find out how to initialize.

https://rd1.sony.net/help/mdr/mov0030/h_zz/

Note

- When the initialization is finished, the headset turns off.
- If you have updated the software after purchasing the headset, the software is retained updated even if you initialize the headset.
- When you initialize the headset to restore to the factory settings after you change the language of the voice guidance, the language will not return to the factory settings.

Wireless Stereo Headset
WF-C500

Specifications

Headset

Power source:

DC 3.85 V: Built-in lithium-ion rechargeable battery
DC 5 V: When charged using USB

Operating temperature:

0 °C to 40 °C (32 °F to 104 °F)

Charging time:

Approx. 2.5 hours (Headset)
Approx. 3 hours (Charging case)

Note

- Charging and usage hours may be different depending on the conditions of use.

Charging temperature:

5 °C to 35 °C (41 °F to 95 °F)

Mass:

Approx. 5.4 g × 2 (0.2 oz × 2) (Headset)
Approx. 35 g (1.24 oz) (Charging case)

Communication specification

Communication system:

Bluetooth Specification version 5.0

Output:

Bluetooth Specification Power Class 1

Maximum communication range:

Line of sight approx. 10 m (30 ft) (*1)

Frequency band:

2.4 GHz band (2.4000 GHz - 2.4835 GHz)

Compatible Bluetooth profiles (*2):

A2DP/AVRCP/HFP/HSP

Supported Codec (*3):

SBC
AAC

Transmission range (A2DP):

20 Hz - 20,000 Hz (Sampling frequency 44.1 kHz)

*1 The actual range will vary depending on factors such as obstacles between devices, magnetic fields around a microwave oven, static electricity, reception sensitivity, antenna's performance, operating system, software application, etc.

*2 Bluetooth standard profiles indicate the purpose of Bluetooth communications between devices.

*3 Codec: Audio signal compression and conversion format

Design and specifications are subject to change without notice.

Compatible iPhone/iPod models

iPhone 12 Pro Max, iPhone 12 Pro, iPhone 12, iPhone 12 mini, iPhone SE (2nd generation), iPhone 11 Pro Max, iPhone 11 Pro, iPhone 11, iPhone XS Max, iPhone XS, iPhone XR, iPhone X, iPhone 8 Plus, iPhone 8, iPhone 7 Plus, iPhone 7, iPhone SE, iPhone 6s Plus, iPhone 6s, iPhone 6 Plus, iPhone 6, iPhone 5s, iPod touch (7th generation), iPod touch (6th generation)

(As of July 2021)