

VIZIO

M-Series™ 2.1.5

User Manual



Dolby Atmos



dts x

Model: **M215aw-K6**

Please read this guide before using the product.



Accessibility

Contact VIZIO for accessibility support at:

Email: accessibility@vizio.com

Phone: 1-877-698-4746

Binding Arbitration Agreement and Class Action Waiver

This purchase is subject to full VIZIO Terms and Conditions, including **Binding Arbitration Agreement and Class Action Waiver**, which may be viewed at vizio.com/en/terms/terms-of-service.

By using this device, you accept those Terms and Conditions.

You have the right to opt out of the Binding Arbitration Agreement and Class Action Waiver within 60 calendar days of your purchase. Please refer to the Limited Warranty section of this User Manual or view the full VIZIO Terms and Conditions for opt-out instructions.

IMPORTANT SAFETY INSTRUCTIONS

Your Unit is designed and manufactured to operate within defined design limits, and misuse may result in electric shock or fire. To prevent your Unit from being damaged, the following rules should be observed for its installation, use, and maintenance. Please read the following safety instructions before operating your Unit. Keep these instructions in a safe place for future reference.

- Heed all warnings.
- Follow all instructions.
- Do not use this Unit near water.
- Clean only with a dry cloth.
- Do not block any ventilation openings. Install in accordance with the manufacturer's instructions.
- Do not install near any heat sources such as radiators, heat registers, stoves, or other Unit (including amplifiers) that produce heat.
- Do not defeat the safety purpose of the polarized or grounding-type plug. A polarized plug has two blades with one wider than the other. A grounding type plug has two blades and a third grounding prong. The wide blade or the third prong are provided for your safety. If the provided plug does not fit into your outlet, consult an electrician for replacement of the obsolete outlet.
- Protect the power cord from being walked on or pinched particularly at the ends where the plug is located, near convenience receptacles, or where they exit from the Unit.
- Only use attachments/accessories specified by the manufacturer.
- Use only with the stand, tripod, or bracket specified by the manufacturer, or sold with the Unit. When a cart is used, use caution when moving the cart/Unit combination to avoid injury from tip-over.
- Unplug this Unit during lightning storms or when unused for long periods of time.
- Refer all servicing to qualified service personnel. Servicing is required when the Unit has been damaged in any way, such as when the power supply cord or plug is damaged, liquid has been spilled or objects have fallen into the Unit, the Unit has been exposed to rain or moisture, does not operate normally, or has been dropped.
- To reduce the risk of electric shock or component damage, switch off the power before connecting other components to your Unit.
- Unplug the power cord before cleaning your Unit. A damp cloth is sufficient for cleaning. Do not use a liquid or a spray cleaner on your Unit. Do not use abrasive cleaners.
- Always use the accessories recommended by the manufacturer to ensure compatibility.
- When moving your Unit from an area of low temperature to an area of high temperature, condensation may form in the housing. Wait before turning on your Unit to avoid causing fire, electric shock, or component damage.
- Slots and openings in the back and bottom of the Unit are provided for ventilation. To ensure reliable operation of your Unit and to protect it from overheating, be sure these openings are not blocked or covered. Do not place your Unit in a bookcase or cabinet unless proper ventilation is provided.
- Never push any object into the slots and openings on your Unit. Do not place any objects on the top of your Unit. Doing so could short circuit parts causing a fire or electric shock. Never spill liquids on your Unit.
- Do not block the subwoofer ports. Allow for 1-2 inches of space around all sides for ventilation.
- **WARNING:** Exposure to loud sounds can damage your hearing causing hearing loss and tinnitus (ringing or buzzing in the ears). With continued exposure to loud noises, ears may become accustomed to the sound level, which may result in permanent damage to hearing without any noticeable discomfort.
- When connected to a power outlet, power is always flowing into your Unit. To totally disconnect power, unplug the power cord.
- Do not overload power strips and extension cords. Overloading can result in fire or electric shock.
- The wall socket should be located near your Unit and be easily accessible.
- Keep your Unit away from moisture. Do not expose your Unit to rain or moisture. If water penetrates into your Unit, unplug the power cord and contact your dealer. Continuous use in this case may result in fire or electric shock.



IMPORTANT SAFETY INSTRUCTIONS

- Do not use your Unit if any abnormality occurs. If any smoke or odor becomes apparent, unplug the power cord and contact your dealer immediately. Do not try to repair your Unit yourself.
- Avoid using dropped or damaged appliances. If your Unit is dropped and the housing is damaged, the internal components may function abnormally. Unplug the power cord immediately and contact your dealer for repair. Continued use of your Unit may cause fire or electric shock.
- Do not install your Unit in an area with heavy dust or high humidity. Operating your Unit in environments with heavy dust or high humidity may cause fire or electric shock.
- Ensure that the power cord and any other cables are unplugged before moving your Unit.
- When unplugging your Unit, hold the power plug, not the cord. Pulling on the power cord may damage the wires inside the cord and cause fire or electric shock. When your Unit will not be used for an extended period of time, unplug the power cord.
- To reduce risk of electric shock, do not touch the connector with wet hands.
- Insert the remote control batteries in accordance with instructions. Incorrect polarity may cause the battery to leak which can damage the remote control or injure the operator.
- Read and follow all warnings printed on the Unit.
- **WARNING:** This equipment is not waterproof. To prevent a fire or shock hazard, do not place any container filled with liquid near the equipment (such as a vase or flower pot) or expose it to dripping, splashing, rain, or moisture.
- **CAUTION:** Danger of explosion or fire if batteries are mistreated. Replace only with the same or specified type.
- Do not leave the batteries exposed to direct sunlight for a long period of time with doors and windows closed. Do not disassemble the batteries or dispose of it in fire.
- If the main wall plug or the appliance coupler is disconnected, the disconnected device will remain readily operable upon reconnection to an appropriate power source.
- No open flames, such as lighted candles, should be placed on the Unit.
- The ventilation should not be impeded by covering the ventilation openings with items, such as newspapers, table-cloths, curtains, etc.
- The equipment shall be used at maximum 35 degree C ambient temperature.

WARNING: To reduce the risk of fire or electric shock, do not expose this Unit to rain or moisture.



The lightning flash with arrowhead symbol within an equilateral triangle is intended to alert the user to the presence of not isolated dangerous voltage within the appliance that may be sufficient magnitude to constitute a risk of shock to persons.



The exclamation point within an equilateral triangle is intended to alert the user to the presence of important operating and servicing instructions in the literature accompanying the appliance.



Warning: This equipment is a Class II or double insulated electrical appliance. It has been designed in such a way that it does not require a safety connection to electrical earth.

TABLE OF CONTENTS

Package Contents	1
Controls & Connections	2
First-time Setup	6
Using the Remote	11
Proper Placement	12
Mode & Level Settings.....	13
Using Button Combinations.....	17
Programming the Sound Bar	18
Bluetooth Pairing.....	19
Using Bluetooth Mode	20
Connecting to a Voice Assistant	21
Advanced Setup	23
Connecting with HDMI ARC	24
Connecting a Subwoofer	26
Wall-mounting.....	27
Product Registration and Support	29
Help & Troubleshooting	30
Limited Warranty	31
Legal & Compliance	34
Specifications	35

Package Contents

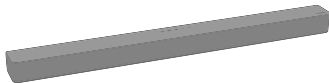

VIZIO
Sound Bar



Wireless Subwoofer



Remote Control
with 2x AAA Batteries



2 x Power Cables



HDMI Cable



2 x Wall
Mount Brackets
(Sound Bar)



Wall Mount
Template



2 x Wall
Mount Screws



Quick Start
Guide

Controls & Connections

Back of Sound Bar

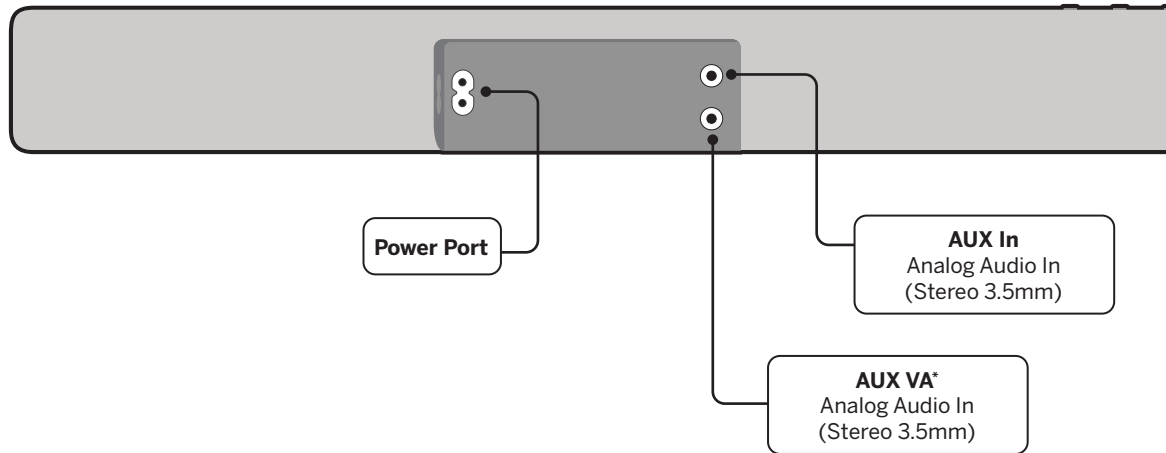

*Only use this port to connect a Voice Assistant device. See Connecting to a Voice Assistant on page 21 for more information.

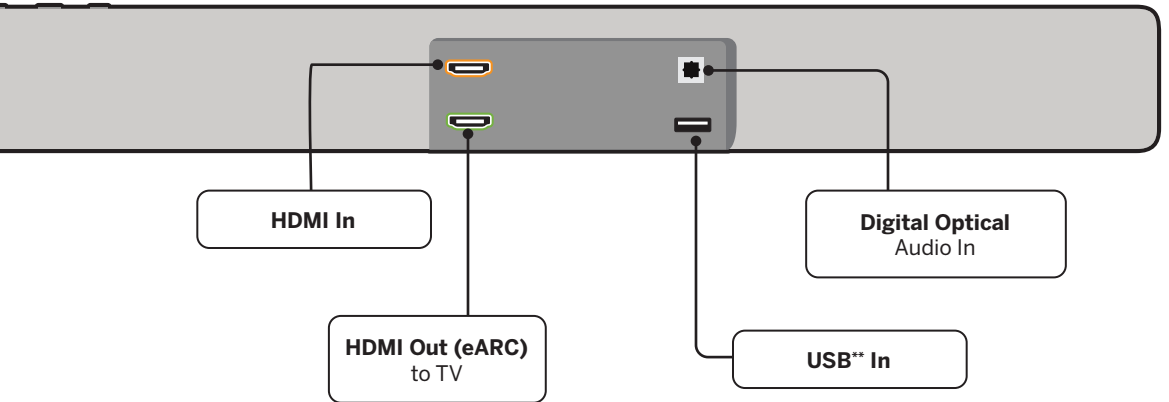

**Supports .WAV and .MP3 file format playback only.

Top of Sound Bar

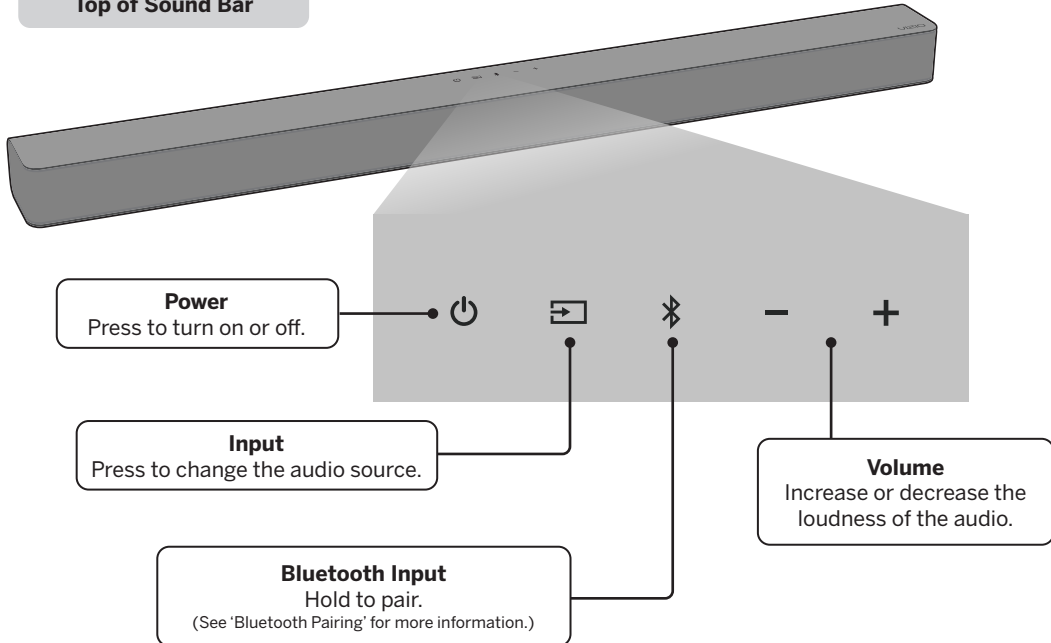

Back of Subwoofer

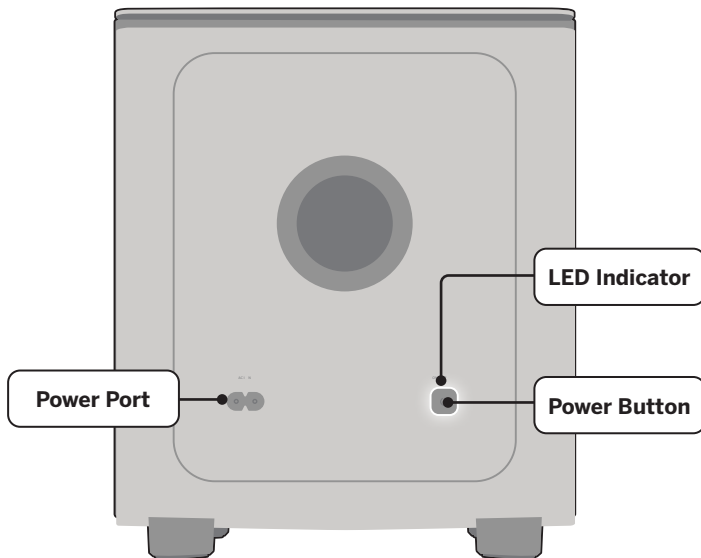

First-time Setup

1

Choose the best possible connection cable type and connect it to your TV.*
(Not all cables are included.)

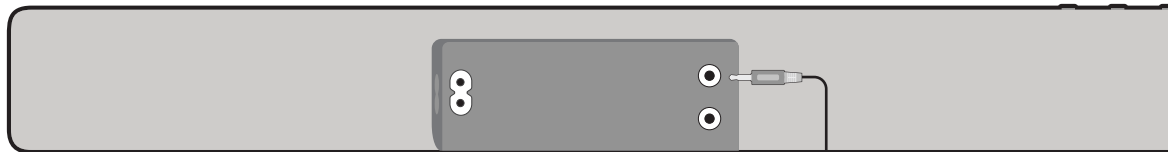

Back of Sound Bar

3.5mm to
RCA Cable
(Not included)

OR

***Not all TVs have the audio outputs shown.**

To connect the sound bar directly to your other devices
(Blu-ray player, game system, etc.) see your device's user manual.

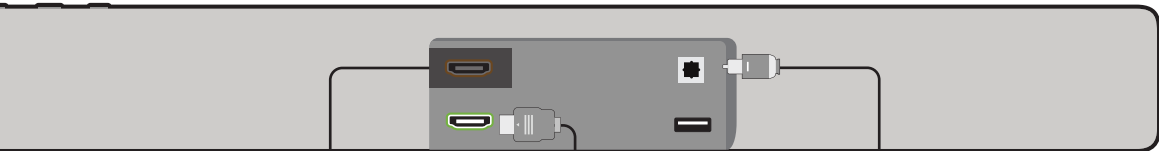

Do not use HDMI In for first-time setup.
See "Advanced Setup" on page 23 to connect other devices to your sound bar.

BEST



**HDMI ARC
Cable**
(Included)

OR



**Digital Optical
Cable****
(Not included)

Be sure the TV port is an **audio output**, not an audio input.

****Some TVs do not pass through digital audio:**

When using the digital input, if there is no audio, try:

- setting the TV output to PCM, or
- connecting directly to your Blu-ray or other source.

First-time Setup

2

Connect the power cable to the sound bar AC IN as shown.

Plug the power cable into an electrical outlet.

Back of Sound Bar

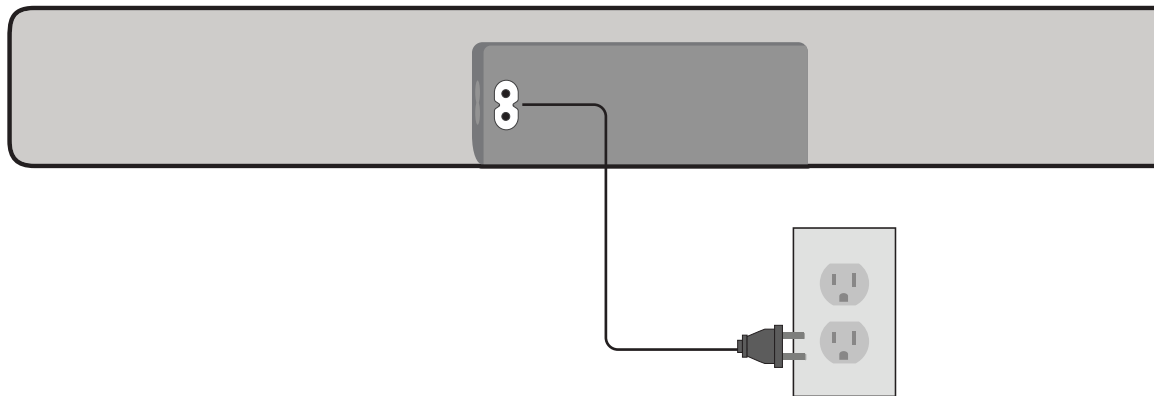

Back of Subwoofer

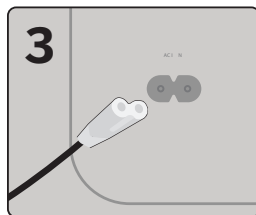
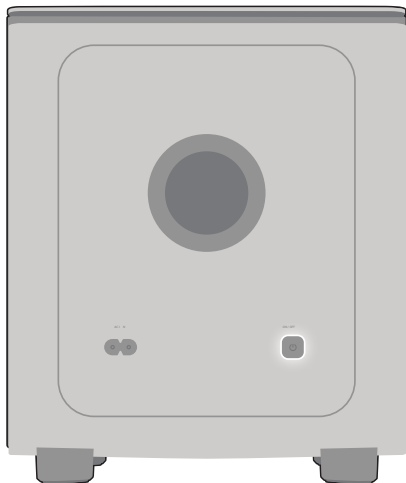

Connect the power cable to the subwoofer.

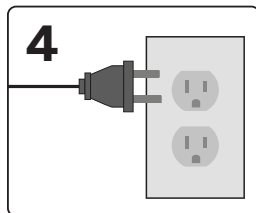

Plug the power cable into a power outlet.

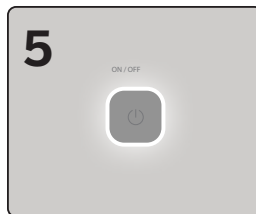

The subwoofer should automatically power on and link to the sound bar when plugged in. The LED will glow to solid to confirm.

First-time Setup

6

Remove the battery cover by gently sliding it away from the remote.



7

Insert the included batteries and gently slide the battery cover back into place.



When needed, VIZIO recommends replacing the batteries that came with this remote with two, new Duracell 'AAA' alkaline batteries.

POWER UP WITH
DURACELL

8

After turning on both your TV and sound bar, it will automatically begin searching for an active input.* The LED indicator on the front of the sound bar will begin cycling in different colors through inputs until an audio source is detected.**

You can press the INPUT button to switch between audio sources.



Tip: Pressing the **INPUT** button will stop the auto detect function.

For example, if you connected your TV to HDMI (ARC), set the sound bar to HDMI eARC.

*Occurs only during first-time set up.

**Auto detect function only occurs once when the sound bar is first powered on. To enable this feature again, you must do a Factory Reset (see the *Using Button Combinations* on page 17 for more information) or press and hold the INPUT button for 3 seconds.

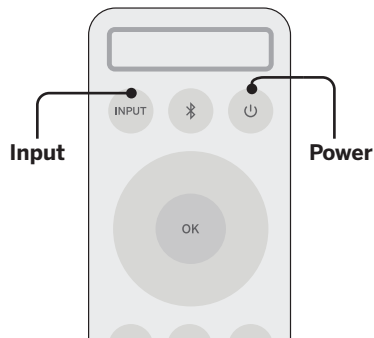

Using the Remote

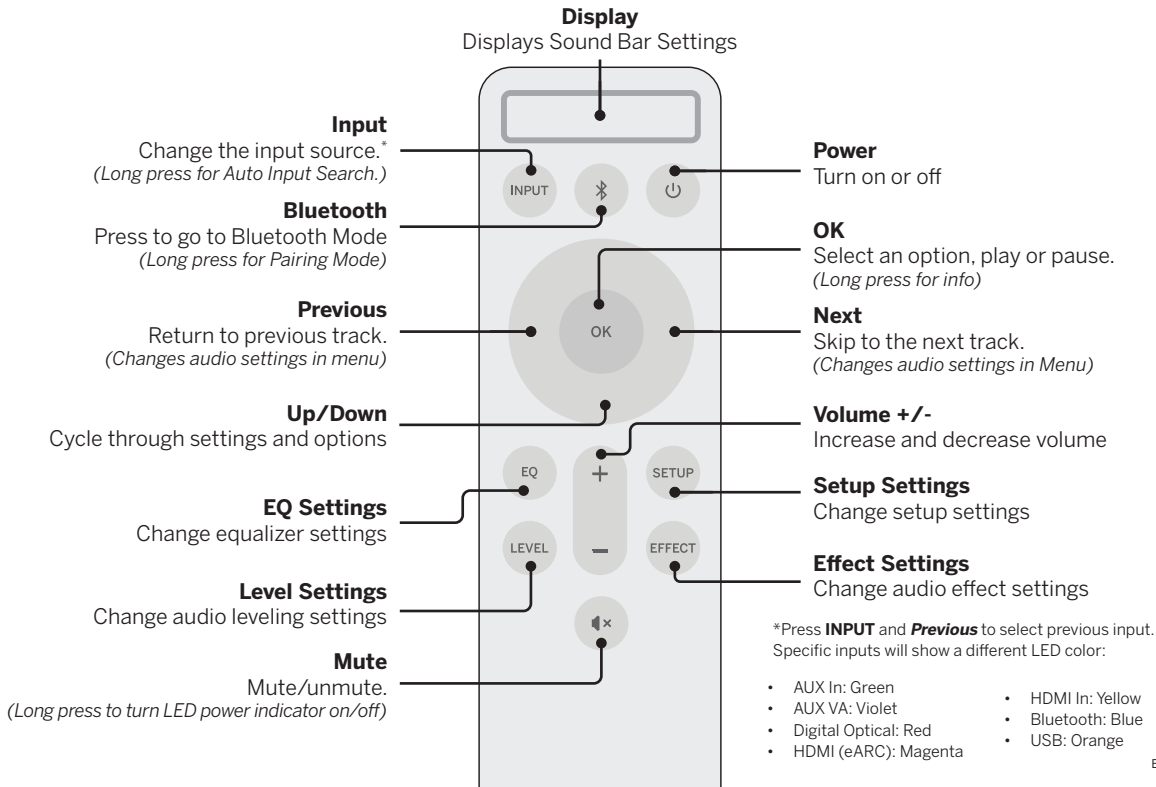

Proper Placement

For the best surround sound experience, position the sound bar and subwoofer as shown. The sound bar should be close to ear level.

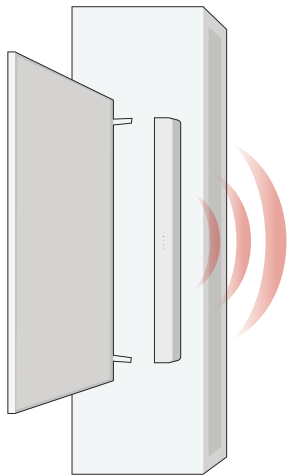

Sound bar should be centered below the TV.

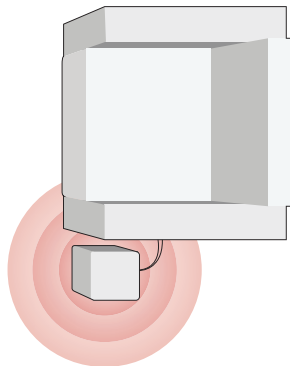

Subwoofer

Note: Do not block the subwoofer port.

Mode & Level Settings

Press each **setting button** and use the **Up/Down** buttons to access the different settings. Each setting will be displayed on the remote control's LCD display. The LED indicators will behave differently with each function.



Function	LED Behavior	Description
Equalizer Mode EQ		Press the EQ button and use the Up/Down buttons to toggle between preset equalizer settings: Movie, Music, Direct, and Game. Note: Movie mode is on by default.
Bass Level Bass		LEVEL > Bass > Use the Next/Previous buttons to increase/decrease the bass level. The LED indicators will move to the top with increasing level and to the bottom with decreasing level.
Treble Level Treble		LEVEL > Treble > Use the Next/Previous buttons to increase/decrease the treble level. The LED indicators will move to the top with increasing level and to the bottom with decreasing level.
Dialogue Level Dialogue		LEVEL > Dialogue > Use the Next/Previous buttons to increase/decrease the dialogue level. The LED indicators will move to the top with increasing level and to the bottom with decreasing level.
Subwoofer Level Sub Lvl		LEVEL > Sub Lvl > Use the Next/Previous buttons to increase/decrease the level of the subwoofer. The LED indicators will move to the top with increasing level and to the bottom with decreasing level. Note: Decreasing the level to the minimum turns off the subwoofer.

Mode & Level Settings

Function	LED Behavior	Description
Info Info	—	SETUP > Info > OK to have the sound bar verbally announce the current sound bar input and audio type being played with corresponding LED indicators.
Auto VA Auto VA		SETUP > Auto VA > Use the Next/Previous buttons to toggle between connecting the sound bar to a Voice Assistant through both, Bluetooth (BT), AUX or off. Refer to <i>Connecting to a Voice Assistant</i> on page 21 for more information. Note: Default setting is AUX.
Eco Power Mode Eco Pwr		SETUP > EcoPwr > Use the Next/Previous buttons to enable/disable Eco Power Mode. When ON, the sound bar will go into standby after a period of inactivity. The sound bar will automatically turn off when no audio signal is detected. Off disables this feature. Note: Default setting is Off
Input Search Input Srch	<p>The LED indicator color will change per specific input.</p>	SETUP > Input Search > OK to initiate an automatic input detection sequence. This is the same as a long key press of the INPUT button on the remote. Specific inputs will show a different LED color: <ul style="list-style-type: none"> • AUX In: Green • AUX VA: Violet • Digital Optical: Red • HDMI In: Yellow • HDMI (eARC): Magenta
Program Remote Learn Prg Remote	<p>Waiting to learn: Flash from bottom to top and back continuously.</p>	SETUP > PrgRemote > Use the Next/Previous buttons and OK button to toggle and select and program your TV remote to control the Volume Down , Volume Up , and Mute functions on your sound bar. See the <i>Programing the Sound Bar on page 18</i> section for more information.
Power LED PwrLED		SETUP > PwrLED > Use the Next/Previous buttons and OK button to enable/disable the Power LED. Voice notifications will also be enabled/disabled.

Function	LED Behavior	Description
AV Delay AV Delay	LED at the bottom indicates no delay.	SETUP > AV Delay > Use the Next/Previous buttons to increase/decrease the amount of audio delay. The LED indicators will move to the top with increasing audio delay level.
Reset Audio or Reset All Reset All	All LEDs will flash 3 times when settings are reset.	SETUP > Reset Audio or Reset All > Use the Next/Previous buttons to reset either Audio or All settings. Press the OK button to select. Audio - Only audio settings, such as bass and treble levels, will be reset. All - All paired Bluetooth devices will be unpaired and all settings will be lost. All programmed IR remotes will also be removed. See the <i>Factory Reset on page 17</i> for more information.
Speaker Test Spkr Test	—	SETUP > Spkr Test > OK to activate the speaker test function. A voice will begin calling out each speaker beginning with <i>left</i> (Left, Right, and subwoofer-white noise). If any of these are missing, check the connection and run the speaker test function again.
VIZIO Remote VZtvRmt	← Remote On Remote Off →	SETUP > VZtvRmt > Use the Next/Previous buttons to enable/disable VIZIO TV Remotes. When enabled (On), you can use a VIZIO TV remote control to turn on the sound bar (using the TV Volume Up button) and control volume.
DTS TruVolume TruVol	← TruVolume On TruVolume Off →	EFFECT > TruVol > Use the Next/Previous buttons to enable/disable TruVolume. When enabled (On), TruVolume provides a consistent and comfortable volume level for a more enjoyable listening experience. Note: Default setting is Off.

Mode & Level Settings

Function	LED Behavior	Description
DTS Virtual:X	← Virtual:X On	EFFECT > VRT:X > Use the Next/Previous buttons to enable/disable Virtual:X . When enabled (On), all inputs will produce a virtual sound technology that simulates the effect of having overhead sound. When disabled (Off), all sources will playback without virtualization.
VRT :X	Virtual:X Off →	
Night Mode	← Night Mode On	EFFECT > Night > Use the Next/Previous buttons to enable/disable Night Mode. When enabled (On), the sound bar will lower bass frequency levels to provide a more quiet environment (ideal for apartment living and homes with sleeping children). Note: Night mode will set to Off after a power cycle.
Night	Night Mode Off →	
Dolby Audio, Dolby Atmos, or DTS audio format is detected.	Dolby Atmos: Green Dolby Audio: White DTS Audio: Amber	Dolby Audio and DTS are available on the HDMI eARC, HDMI In, and Digital Optical inputs. Dolby Atmos is available on HDMI eARC and HDMI In when connected to supported devices and streaming services. When a Dolby or DTS signal is detected, the bottom indicator LED will light up for 5 seconds before fading away.

Using Button Combinations

There are other functions that are triggered by different button combinations on the sound bar.



Buttons are located here.

Function	LED Behavior	Description
Factory Reset	All LEDs will flash 3 times	Reset the sound bar to the factory default settings. To perform a Factory Reset, Press and Hold the Bluetooth (📶) and Volume Down (–) buttons for 5 seconds. Note: This will erase all settings and preferences that you have set.
VIZIO TV Remote Control	← Enable VIZIO TV remote Disable VIZIO TV remote →	Enable/disable the use of a VIZIO TV remote control to power on and adjust the volume of the sound bar. To enable/disable this function, Press and Hold the Power (⏻) and Volume Up (+) buttons for 5 seconds.
Eco Power Mode	← Enable Eco Power Disable Eco Power →	When the Eco Power mode setting is enabled, the sound bar will automatically power down after a period of inactivity. When disabled, the sound bar will remain powered on until you turn it off. To enable/disable this function, Press and Hold the Power (⏻) and Volume Down (–) buttons for 5 seconds. Note: Eco Power Mode setting is OFF by default.

Programming the Sound Bar

You can program your sound bar to accept TV remote IR commands.

- Press the **SETUP** button on the remote, then use the **Up/Down** buttons to navigate to **Prg Remote**.
- Use the **Next/Previous** buttons to toggle through Learn Vol -, Learn Vol +, and Learn Mute.

Function	LED Behavior	Description
Learn Volume Down Learn Vol-	Waiting to learn: Flash from bottom to top and back continuously.	Press the OK button to put the sound bar into learning mode. While the sound bar is in learning mode, press the Volume Down button on the TV remote control.
Learn Volume Up Learn Vol+		Press the OK button to put the sound bar into learning mode. While the sound bar is in learning mode, press the Volume Up button on the TV remote control.
Learn Mute Learn Mute	Learning confirmed: All of the LEDs will blink twice.	Press the OK button to put the sound bar into learning mode. While the sound bar is in learning mode, press the Mute button on the TV remote control.



Point both the sound bar and TV remotes towards the front of the sound bar when programming.

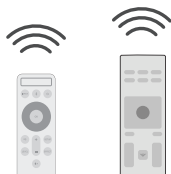

Turn off your TV speakers when programming your sound bar.

To pair the sound bar with a Bluetooth device:

1. **Press and hold** the Bluetooth button  on the sound bar or remote control for five (5) seconds.
2. Search for the sound bar (*VIZIO M215aw*) using your Bluetooth device. For more information, refer to the user documentation that came with the device.
3. Now you can play audio from your Bluetooth device. Volume can be controlled on both your source device and the sound bar.



Bluetooth Device

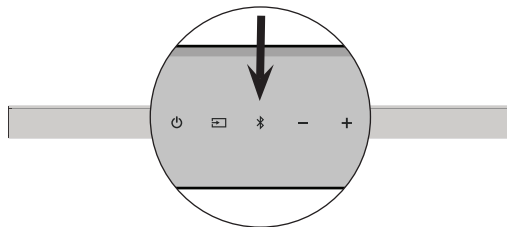

Button Located at the Top of Sound Bar



The LED indicators on the display panel on the front of the sound bar will light up sequentially from bottom to top and back again. Once the device is paired, the LED indicators will stop flashing.

Using Bluetooth Mode

1. Your sound bar supports music streaming from devices with Bluetooth capability.
(Device compatibility will vary, see your device's documentation for more information.)
2. Once you have paired your source device to the sound bar your device should remain paired (within range).
3. If the source is changed back to Bluetooth, any paired Bluetooth device will reconnect automatically.
4. If the input is changed, the Bluetooth device will disconnect.

Maximizing Signal

A Bluetooth signal has a range of up to 30 feet. Keep in mind that Bluetooth is a compressed audio format, so streamed music may lose some integrity when compared to a wired connection. Try the following if your sound quality is less than optimal:

- If you hear any break-up or disconnect while streaming music from your device, move the source device closer to the sound bar.
- Be sure that there are no solid obstructions in the line-of-sight between the sound bar and the source device.
- Other wireless devices can affect Bluetooth range, including wireless security cameras, wireless video baby monitors, cordless phones, and microwave ovens. Turning off or moving these devices may improve Bluetooth range.



Your sound bar is not equipped with a microphone, so it cannot operate as a hands-free device for a smartphone.



Reduce the volume levels on your device and on the sound bar before pressing Play. High volume levels can damage your hearing.

Connecting to a Voice Assistant

Your sound bar can connect to a Voice Assistant (VA) device through an AUX VA or Bluetooth connection.

Once connected, your sound bar will now act as the VA speaker.

Features and Benefits:

- **Voice Assistant Dedicated Input:** VA can be active on the sound bar even if the sound bar is set to a different input with audio playing.
- **Auto Muting:** If playing audio from the sound bar, the VA will play over the original source audio for 10 seconds. If continued after the 10 seconds, the VA audio will mute the original source audio. Once the VA audio is stopped the original source audio will resume.



Make sure your sound bar is turned **ON** and Eco Power setting is turned **OFF**. Refer to *Eco Power mode* on page 14 to disable.

Setup Tips:

- If the VA audio is too low, adjust the volume from the VA device.
- If the start of the response from the VA is cut off, enable “Start of Request” from your VA app settings.
- **To disable the VA function**, use the display remote to turn the Auto VA feature to OFF. Refer to *Auto VA on page 14* for more information.

Connecting to a Voice Assistant

Turn on the AUTO VA Settings:

1. Press the **Setup**  button and use the **up/down buttons** to go to the **AUTO VA** setting.
2. Use the **left/right buttons** to change the setting to **AUX/BT or BOTH** (depending on how you connect).

Using the AUX VA Port to Connect

(If there is no AUX port on the VA device, use a Bluetooth connection instead.)

- Use a 3.5mm audio cable to connect the **AUX VA port on the sound bar** to an AUX port on your voice assistant device.

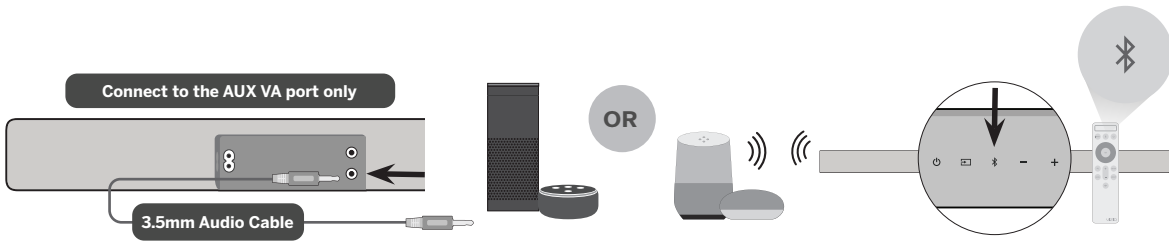

Using Bluetooth to Connect

- Press and hold the **Bluetooth button on the sound bar** or **remote** for three (3) seconds. Search for the sound bar (VIZIO M215aw) using your VA device app. For more information, refer to the user documentation that came with the device.

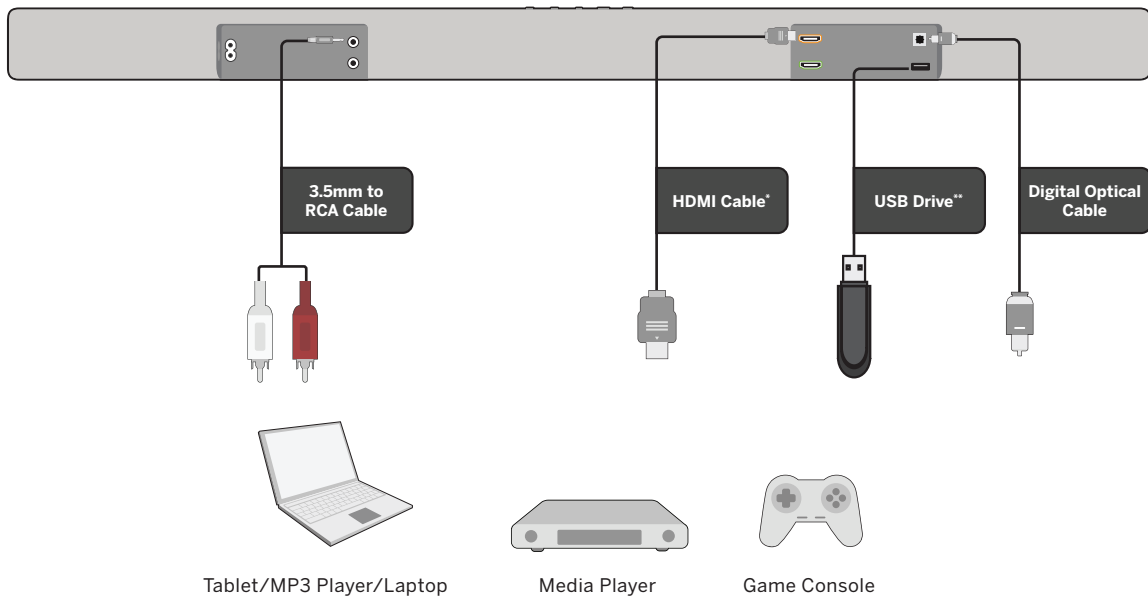

*Always use HDMI 2.0 certified cables.

**Supports .WAV and .MP3 file format playback only.

Connecting with HDMI ARC

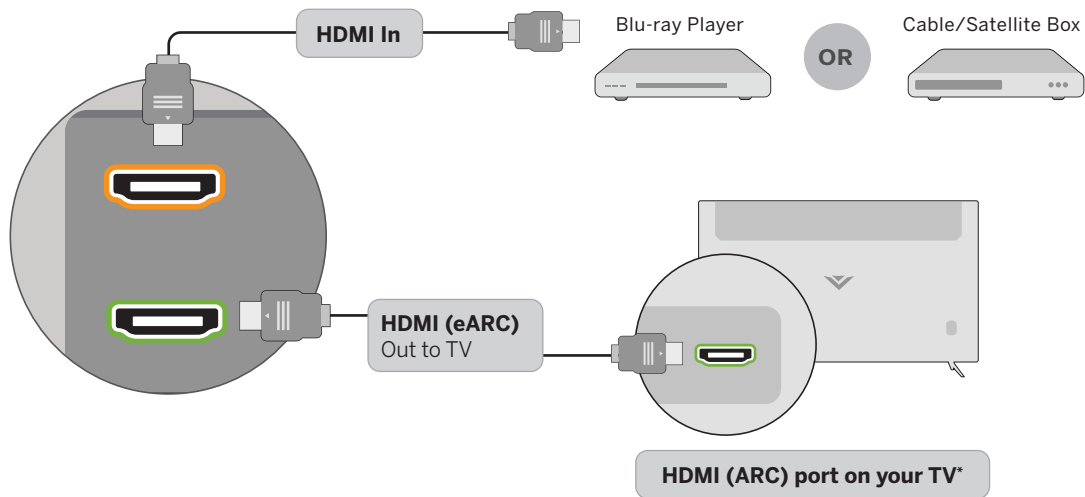

HDMI cables transmit both audio and video.

To view video from these devices:

1. Turn the sound bar on.
2. Set the sound bar input to HDMI In.
3. Set your TV input to the same HDMI port that the sound bar is connected to.

* HDMI ARC port location may differ by TV manufacturer. See your TV's user manual for more information.



Dolby Vision® Compatible

HDMI ports pass through the highest-quality audio and video formats.

What is HDMI Audio Return Channel (ARC)?

- Using HDMI ARC, your TV can send audio to the sound bar using an HDMI cable.
- Connect your sound bar to your TV's HDMI ARC port using an HDMI cable that is ARC compatible.

To connect using HDMI*:

1. Connect one end of the HDMI cable to the **HDMI 1 (ARC)** port on the back of your TV.
2. Connect the other end to the **HDMI (eARC)** port on your sound bar.
3. From the AUDIO menu on your TV, change the Digital Audio Setting to **Dolby Digital** or **Bitstream**.
4. From the SYSTEM menu, enable CEC and ARC (SAC)[†] functions.
5. From the CEC menu, select Device Discovery to register the sound bar with the TV.



If you want to use the TV remote to control the sound bar volume:
Enable System Audio Control from the CEC menu.

* The following steps are for use with a VIZIO TV, steps may differ by TV manufacturer. See your TV's user manual for more information.

† CEC Function naming may differ by TV manufacturer. See your TV's user manual for more information.

Connecting a Subwoofer



What does pairing mean?
Pairing means to wirelessly connect.

The subwoofer has already been paired with the sound bar by VIZIO. However, the subwoofer may need to be re-linked to the sound bar if there is no sound coming from the subwoofer.

1

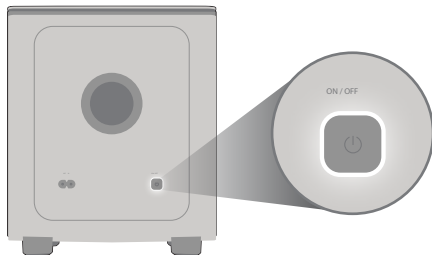

Back of subwoofer

First confirm that the power LED is illuminated. **Press and hold** the **ON/OFF** button on the back of the subwoofer for 5 seconds. The LED on the back of the subwoofer will begin to blink.

2

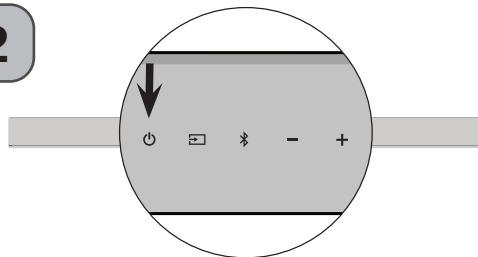

Button Located at the Top of Sound Bar

Press and hold the Power button on the top of the sound bar for 5 seconds. The LED indicators on the front will flash 3 times. The subwoofer is now linked with the sound bar.

1

Place the included wall mounting template against the wall under your TV. Mark the two bracket holes using a pencil.

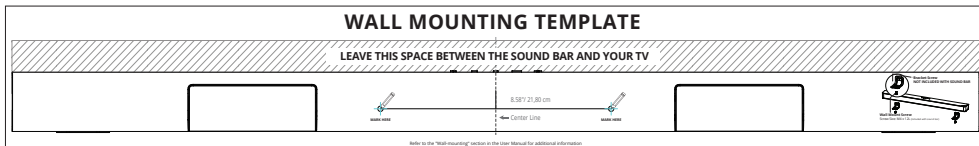

2

Then place the shorter end of the bracket on the two holes you just marked and screw into the wall. Be sure your screws are attached to wood studs, drywall anchors (for drywall), or concrete anchors (for brick/concrete walls).



Screws for attaching the bracket to the wall are not included. Choose the screw type and length appropriate to your home's construction. If in doubt, consult a professional installer.

Bracket Screw*
(Not included with sound bar)

Suggested screw size: 3.5 mm diameter,
1.63" minimum length

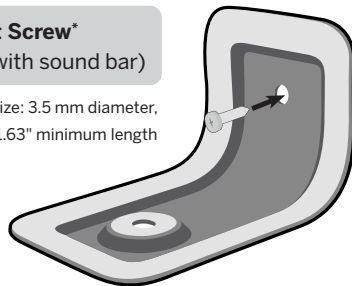

* Do not use any of the included screws for the wall mount installation. These are not intended for mounting.

Wall-mounting

- 3** Place sound bar onto the L-shaped bracket and use the included bracket screws to attach.

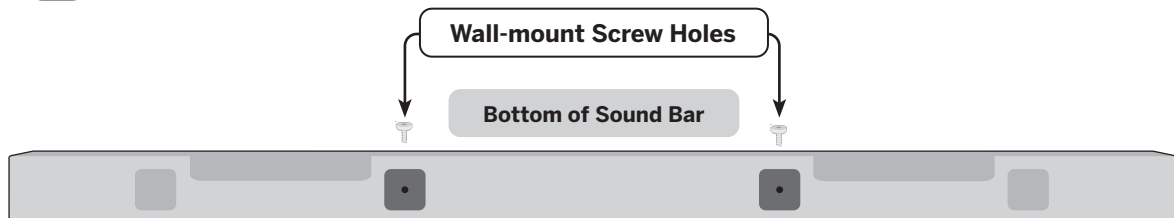

* Do not use any of the included screws for the wall mount installation. These are not intended for mounting.

Wall-mount Screw
(Included with sound bar)

Screw size: M4 x 8L

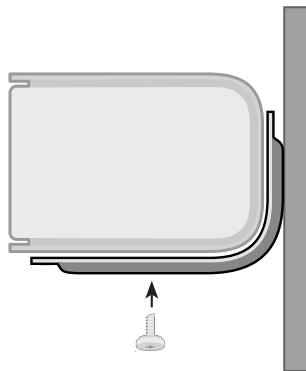

Get helpful tips and register your sound bar.

Scan with your phone camera or QR reader.



Customized Support

Get assistance quickly with your information on hand.



News and Offers

Take advantage of the latest news and special offers from VIZIO.



Updates and Enhancements

Stay up-to-date with important product updates and notifications.

More questions? Find answers at:

SUPPORT.VIZIO.COM

Help & Troubleshooting

There is no power.	<ul style="list-style-type: none">• Press the POWER button on the remote control or on the top of your sound bar.• Ensure the power cord is securely connected.• Plug a different device into the electrical outlet to verify that the outlet is working correctly.
There is no sound.	<ul style="list-style-type: none">• Increase the volume. Press VOLUME UP on the remote control or on the top of your sound bar.• Press MUTE on the remote to ensure the sound bar is not muted.• Press INPUT on the remote or on the top of your sound bar to select a different input source.• When using the Digital Optical input, if there is no audio: (A) try setting the TV output to PCM or (B) connect directly to your Blu-ray/other source, some TVs do not pass through digital audio.• On digital inputs, the input LEDs will flash rapidly and announce "format not supported" if an unsupported format is present. Set the source to output PCM.• Your TV may be set to variable audio output. Confirm that the audio output setting is set to FIXED or STANDARD, not VARIABLE. Consult your TV's user manual for more detailed information.• If using Bluetooth, ensure that the volume on your source device is turned up and that the device is not muted.
I hear buzzing or humming.	<ul style="list-style-type: none">• Ensure all cables and wires are securely connected.• Connect a different source device (TV, Blu-ray player, etc) to see if the buzzing persists. If it does not, the problem may be with the original device.• Connect your device to a different input on the sound bar.
The remote isn't working.	<ul style="list-style-type: none">• Replace the remote batteries with new ones.• Point the remote directly at the center of the sound bar when pressing a button.• If using a Bluetooth connection, some of the buttons on the remote may not be supported by the streaming application.

UNITED STATES

By using this VIZIO product, you accept all VIZIO Terms and Conditions, including all the Terms of Warranty, BINDING ARBITRATION AGREEMENT, and Class Action Waiver. If you do not agree to the terms of this warranty, do not use the VIZIO product and, within thirty (30) days of the date of purchase, return it for a refund to the authorized retailer where you purchased it. **You have the right to opt out of the Arbitration Agreement and Class Action Waiver within 60 calendar days of your purchase.** Please refer to the full section "Binding Arbitration Agreement; Class Action Waiver" below for more details and instructions for opt-out. Full Terms and Conditions may be viewed at vizio.com/en/terms/terms-of-service.

How Long This Warranty Lasts

For non-commercial use, VIZIO warrants the product on the terms set forth below for one (1) year from the date of original purchase. For commercial use, VIZIO warrants this product on the terms set forth below for ninety (90) days from the date of original purchase.

What This Warranty Covers

VIZIO warrants the product against defects in materials and workmanship when the product is used normally in accordance with VIZIO's user guides and manuals. Except where restricted by law, this warranty applies only to the original purchaser of a new product. The purchase must have been made from an authorized retailer in the United States (including Puerto Rico). The product must also be located in the country where it was purchased at the time of warranty service.

How to Get Service

Before obtaining warranty service, you may visit www.vizio.com for additional help and troubleshooting. To obtain warranty service, contact VIZIO Customer Support by going to support.vizio.com and selecting Contact Us. You can also call Customer Support (US): 855-209-4106.

Your Obligations Before Service

You must obtain pre-authorization before sending your product to a VIZIO service center. You may be required to supply a purchase receipt (or copy) to show that the product is within the warranty period.

When you return a product to a VIZIO service center, you must ship the product in its original packaging or in packaging that affords an equal degree of protection. VIZIO Technical Support will provide instructions for packing and shipping the product to the VIZIO service center.

ALL USER DATA AND DOWNLOADED APPLICATIONS STORED ON A PRODUCT WILL BE DELETED IN THE COURSE OF SOME IN-HOME AND ALL SHIP-IN WARRANTY SERVICE. If this occurs, your product will be restored to its original state. You will be responsible for restoring all applicable user data and downloaded applications. Recovery and reinstallation of user data and downloaded applications is not covered under this warranty. In order to protect your personal information, VIZIO recommends that you always clear all personal information from the product before it is serviced, regardless of the servicer.

VIZIO's Responsibilities

If VIZIO determines that a product is covered by this warranty, VIZIO will (at its option) repair or replace it, or refund the purchase price to you. There will be no charge for parts or labor during the warranty period. Replacement parts may be new or recertified at VIZIO's option and sole discretion. Replacement parts and VIZIO's labor are warranted for the remaining portion of the original warranty or for ninety (90) days from warranty service, whichever is longer.

Types of Service

Products must be sent to a VIZIO service center to obtain warranty service. VIZIO is not responsible for transportation costs to the service center, but VIZIO will cover return shipping to the customer.

Limited Warranty

What This Warranty Does Not Cover

This warranty does not cover: (a) cosmetic damage; (b) normal wear and tear; (c) improper operation; (d) improper voltage supply or power surges; (e) signal issues; (f) damage from shipping; (g) acts of God; (h) customer misuse, modifications or adjustments; (i) installation, set-up, or repairs attempted by anyone other than by a VIZIO authorized service center; (j) products with unreadable or removed serial numbers; (k) products requiring routine maintenance; or (l) products sold "AS IS", "CLEARANCE", "FACTORY RECERTIFIED", or by a non-authorized reseller.

What to Do If You Are Not Satisfied With Service

If you feel VIZIO has not met its obligations under this warranty, you may attempt to resolve the issue informally with VIZIO. If you are unable to resolve the issue informally and wish to file a formal claim against VIZIO, and if you are a resident of the United States, you must submit your claim to binding arbitration according to the procedures described below, unless an exception applies. Submitting a claim to binding arbitration means that you do not have the right to have your claim heard by a judge or jury. Instead your claim will be heard by a neutral arbitrator.

Binding Arbitration Agreement; Class Action Waiver (U.S. Residents Only)

UNLESS YOU HAVE BROUGHT AN ELIGIBLE CLAIM IN SMALL CLAIMS COURT OR HAVE OPTED OUT AS DESCRIBED BELOW, ANY CONTROVERSY OR CLAIM RELATING IN ANY WAY TO YOUR VIZIO PRODUCT, INCLUDING ANY CONTROVERSY OR CLAIM ARISING OUT OF OR RELATING TO THIS WARRANTY, A BREACH OF THIS WARRANTY, OR THE VIZIO PRODUCT'S SALE, CONDITION OR PERFORMANCE, WILL BE SETTLED BY BINDING ARBITRATION ADMINISTERED BY THE AMERICAN ARBITRATION ASSOCIATION AND CONDUCTED BY A SINGLE ARBITRATOR APPOINTED BY THE AMERICAN ARBITRATION ASSOCIATION, IN ACCORDANCE WITH ITS COMMERCIAL ARBITRATION RULES AND ITS SUPPLEMENTARY PROCEDURES FOR CONSUMER-RELATED DISPUTES. You may learn more about the American Arbitration Association and its rules for arbitration by visiting www.adr.org. Since this warranty concerns a transaction in interstate or international commerce, the Federal Arbitration Act will apply.

The filing fees to begin and carry out arbitration will be shared between you and VIZIO, but in no event will your fees ever exceed the amount allowable by the American Arbitration Association, at which point VIZIO will cover all additional administrative fees and expenses. VIZIO waives its right to recover attorneys' fees in connection with any arbitration under this warranty. If you are the prevailing party in an arbitration to which the Supplementary Procedures for Consumer-Related Disputes applies, then you are entitled to recover attorneys' fees as the arbitrator may determine.

The dispute will be governed by the laws of the state or territory in which you resided at the time of your purchase (if in the United States). The place of arbitration will be Irvine, California, or your county of residence (if in the United States). The arbitrator will have no authority to award punitive or other damages not measured by the prevailing party's actual damages, except as may be required by statute. The arbitrator will not award consequential damages, and any award will be limited to monetary damages and will include no equitable relief, injunction, or direction to any party other than the direction to pay a monetary amount. Judgment on the award rendered by the arbitrator will be binding and final, except for any right of appeal provided by the Federal Arbitration Act, and may be entered in any court having jurisdiction. Except as may be required by law, neither you nor VIZIO nor an arbitrator may disclose the existence, content, or results of any arbitration under this warranty without the prior written consent of you and VIZIO.

ANY DISPUTE, WHETHER IN ARBITRATION, IN COURT, OR OTHERWISE, WILL BE CONDUCTED SOLELY ON AN INDIVIDUAL BASIS. VIZIO AND YOU AGREE THAT NO PARTY WILL HAVE THE RIGHT OR AUTHORITY FOR ANY DISPUTE TO BE ARBITRATED AS A CLASS ACTION, A PRIVATE ATTORNEY GENERAL ACTION, OR IN ANY OTHER PROCEEDING IN WHICH EITHER PARTY ACTS OR PROPOSES TO ACT IN A REPRESENTATIVE CAPACITY.

NO ARBITRATION OR PROCEEDING WILL BE JOINED, CONSOLIDATED, OR COMBINED WITH ANOTHER ARBITRATION OR PROCEEDING WITHOUT THE PRIOR WRITTEN CONSENT OF ALL PARTIES TO ANY SUCH ARBITRATION OR PROCEEDING.

Opt-Out Instructions

IF YOU DO NOT WISH TO BE BOUND BY THE BINDING ARBITRATION AGREEMENT AND CLASS ACTION WAIVER, THEN: (1) you must notify VIZIO in writing within sixty (60) days of the date that you purchased the product; (2) your written notification must be mailed to VIZIO at 39 Tesla, Irvine, CA 92618, Attn: Legal Department; and (3) your written notification must include (a) your name, (b) your address, (c) the date you purchased the product, and (d) a clear statement that you wish to opt out of the binding arbitration agreement and class action waiver.

In addition, you may pursue a claim in small claims court in your county of residence (if in the United States) or in Orange County, California. In such case the provisions of the section titled "Binding Arbitration Agreement; Class Action Waiver (U.S. Residents)" will not apply.

Exclusions and Limitations

TO THE GREATEST EXTENT PERMITTED BY APPLICABLE LAW, THERE ARE NO EXPRESS WARRANTIES OTHER THAN THOSE DESCRIBED ABOVE. ANY IMPLIED WARRANTIES, INCLUDING ANY IMPLIED WARRANTY OF MERCHANTABILITY AND FITNESS FOR A PARTICULAR PURPOSE, WILL BE LIMITED IN DURATION TO THE WARRANTY PERIOD SET FORTH ABOVE. SOME STATES AND PROVINCES DO NOT ALLOW LIMITATIONS ON HOW LONG AN IMPLIED WARRANTY LASTS, SO THE ABOVE LIMITATION MAY NOT APPLY TO YOU.

VIZIO WILL NOT BE RESPONSIBLE FOR LOSS OF USE, LOSS OF INFORMATION OR DATA, COMMERCIAL LOSS, LOST REVENUE OR LOST PROFITS, OR OTHER INDIRECT, SPECIAL, INCIDENTAL OR CONSEQUENTIAL DAMAGES, EVEN IF VIZIO HAS BEEN ADVISED OF THE POSSIBILITY OF SUCH DAMAGES, AND EVEN IF THE REMEDY FAILS OF ITS ESSENTIAL PURPOSE. SOME STATES AND PROVINCES DO NOT ALLOW THE EXCLUSION OR LIMITATION OF INCIDENTAL OR CONSEQUENTIAL DAMAGES, SO THE ABOVE LIMITATION OR EXCLUSION MAY NOT APPLY TO YOU.

IN LIEU OF ANY OTHER REMEDY FOR ANY AND ALL LOSSES AND DAMAGES RESULTING FROM ANY CAUSE WHATSOEVER (INCLUDING VIZIO'S NEGLIGENCE, ALLEGED DAMAGE, OR DEFECTIVE GOODS, NO MATTER WHETHER SUCH DEFECTS ARE DISCOVERABLE OR LATENT), VIZIO MAY, AT ITS SOLE AND EXCLUSIVE OPTION AND IN ITS DISCRETION, REPAIR OR REPLACE YOUR PRODUCT, OR REFUND ITS PURCHASE PRICE. AS NOTED, SOME STATES AND PROVINCES DO NOT ALLOW THE EXCLUSION OR LIMITATION OF INCIDENTAL OR CONSEQUENTIAL DAMAGES, SO THE ABOVE LIMITATION OR EXCLUSION MAY NOT APPLY TO YOU.

How the Law Applies

This warranty gives you specific legal rights, and you may also have other rights, which vary from state to state and province to province. This warranty applies to the greatest extent permitted by applicable law.

General

No employee or agent of VIZIO may modify this warranty. If any term of this warranty, other than the class action waiver, is found to be unenforceable, that term will be severed from this warranty and all other terms will remain in effect. If the class action waiver is found to be unenforceable, then the entire section titled "Binding Arbitration Agreement; Class Action Waiver (U.S. Residents Only)" will not apply. This warranty applies to the maximum extent not prohibited by law.

Changes to Warranty

This warranty may change without notice, but any change will not affect your original warranty. Check www.vizio.com for the most current version.

Legal & Compliance

FCC Class B Radio Interference Statement

NOTE: This equipment has been tested and found to comply with the limits for a Class B digital device, pursuant to Part 15 of the FCC Rules. These limits are designed to provide reasonable protection against harmful interference in a residential installation. This equipment generates, uses and can radiate radio frequency energy, and if not installed and used in accordance with the instructions, may cause harmful interference to radio communications. However, there is no guarantee that interference will not occur in a particular installation. If this equipment does cause harmful interference to radio or television reception, which can be determined by turning the equipment off and on, the user is encouraged to try to correct the interference by one or more of the following measures:

1. Reorient or relocate the receiving antenna.
2. Increase the separation between the equipment and receiver.
3. Connect the equipment into an outlet on a circuit different from that to which the receiver is connected.
4. Consult the dealer or an experienced radio/TV technician for help.

This device complies with Part 15 of the FCC Rules. Operation is subject to the following two conditions: (1) this device may not cause harmful interference, and (2) this device must accept any interference received, including interference that may cause undesired operation.

Notice:

1. Any Changes or modifications not expressly approved by the party responsible for compliance could void the user's authority to operate the equipment.
2. Shielded interface cables and AC power cord, if any, must be used in order to comply with the emission limits.
3. The manufacturer is not responsible for any radio or TV interference caused by unauthorized modification to this equipment. It is the responsibilities of the user to correct such interference.

FCC RF Radiation Exposure Statement

1. This transmitter must not be collocated or operating in conjunction with any other antenna or transmitter.
2. This equipment complies with FCC radiation exposure limits set forth for an uncontrolled environment. This equipment should be installed and operated with minimum distance 20cm between the radiator & your body.
3. FCC RF Warning

This equipment must be installed and operated in accordance with provided instructions and the antenna(s) used for this transmitter must be installed to provide a separation distance of at least 20cm from all persons and must not be co-located or operating in conjunction with any other antenna or transmitter. End-users and installers must be provided with antenna installation instructions and transmitter operating conditions for satisfying RF exposure compliance.

Battery Disposal and Recycling

You must dispose of this product properly, according to local laws and regulations. Because this product contains electronic components and/ or a battery, it must be disposed of separately from household waste. Contact local authorities to learn about disposal and recycling options. For more information, visit vizio.com/environment or call (800) 374-3473..

Software Licenses

All software is provided subject to software license agreements and you agree that you will be bound by such license agreements in addition to other applicable terms of use. By using the VIZIO products, you agree to the VIZIO Terms of Service and Privacy Policy. The VIZIO Terms of Use and Privacy Policy may be updated from time to time and are available to view at vizio.com/terms and vizio.com/privacy, respectively.

Export Regulations

Customer acknowledges that the VIZIO products, which include technology and software, are subject to customs and export control laws in the United States ("US"). The products may also be subject to the customs and export control laws and regulations of the country in which the products are manufactured and/or received.

© 2022 VIZIO, Inc. All Rights Reserved.

This User Manual may not be copied in whole or in part without the written permission of VIZIO, Inc. VIZIO, Inc. has made reasonable efforts to ensure the accuracy of the information provided herein. All product specifications, functionality, features, configurations, performance, design and other product information described herein are subject to change without notice. VIZIO, Inc. is not responsible for typographical, technical, or descriptive errors. To review the most updated version of this User Manual and the associated Quick Start Setup guide, go to vizio.com.

VIZIO, the VIZIO logo, the V logo, and other terms and phrases are trademarks or registered trademarks of VIZIO, Inc.

Specifications

Sound Bar:	One 1.66" x 3.48" (42.3 x 88.5 mm) Full Range Driver for each channel (1 for left, 1 for right) One 0.79" (20 mm) Tweeter for each channel (1 for left, 1 for right)	
Subwoofer:	One 5" (127 mm) Driver	
Connections:	One 3.5mm Stereo Audio One Optical (Toslink) HDMI (eARC)	HDMI In One 3.5mm AUX Voice Assistant Bluetooth One USB (Supports .WAV and .MP3 format only)
Sound Pressure Level* (System):	100 dB	
Frequency Response (System):	50 Hz - 20 KHz	
Voltage:	100-240Vac, 50/60Hz	
Compliances:	UL 62368-1, FCC PART15 Class B	

*Sound pressure level measured using pink noise at 1 meter, c-weighted.



The terms HDMI, HDMI High-Definition Multimedia Interface, and the HDMI Logo are trademarks or registered trademarks of HDMI Licensing Administrator, Inc.



The Bluetooth® word mark and logos are registered trademarks owned by Bluetooth SIG, Inc. and any use of such marks by VIZIO Inc. is under license. Other trademarks and trade names are those of their respective owners.



Dolby, Dolby Atmos, and the Double-D symbol are trademarks of Dolby Laboratories Licensing Corporation. Manufactured under license from Dolby Laboratories. Confidential unpublished works. Copyright © 1992-2021 Dolby Laboratories. All rights reserved.



For DTS patents, see <http://patents.dts.com>. Manufactured under license from DTS, Inc. DTS, DTS:X, Virtual:X, the DTS:X logo are registered trademarks or trademarks of DTS, Inc. in the United States and other countries. © 2021 DTS, Inc. ALL RIGHTS RESERVED.





© 2022 VIZIO INC. ALL RIGHTS RESERVED.
221231BT